

THE OFFICIAL RASPBERRY PI MAGAZINE

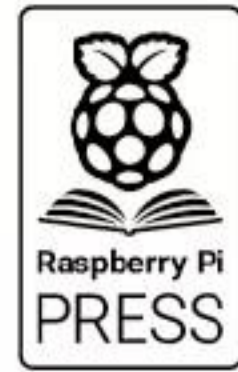

The *MagPi*

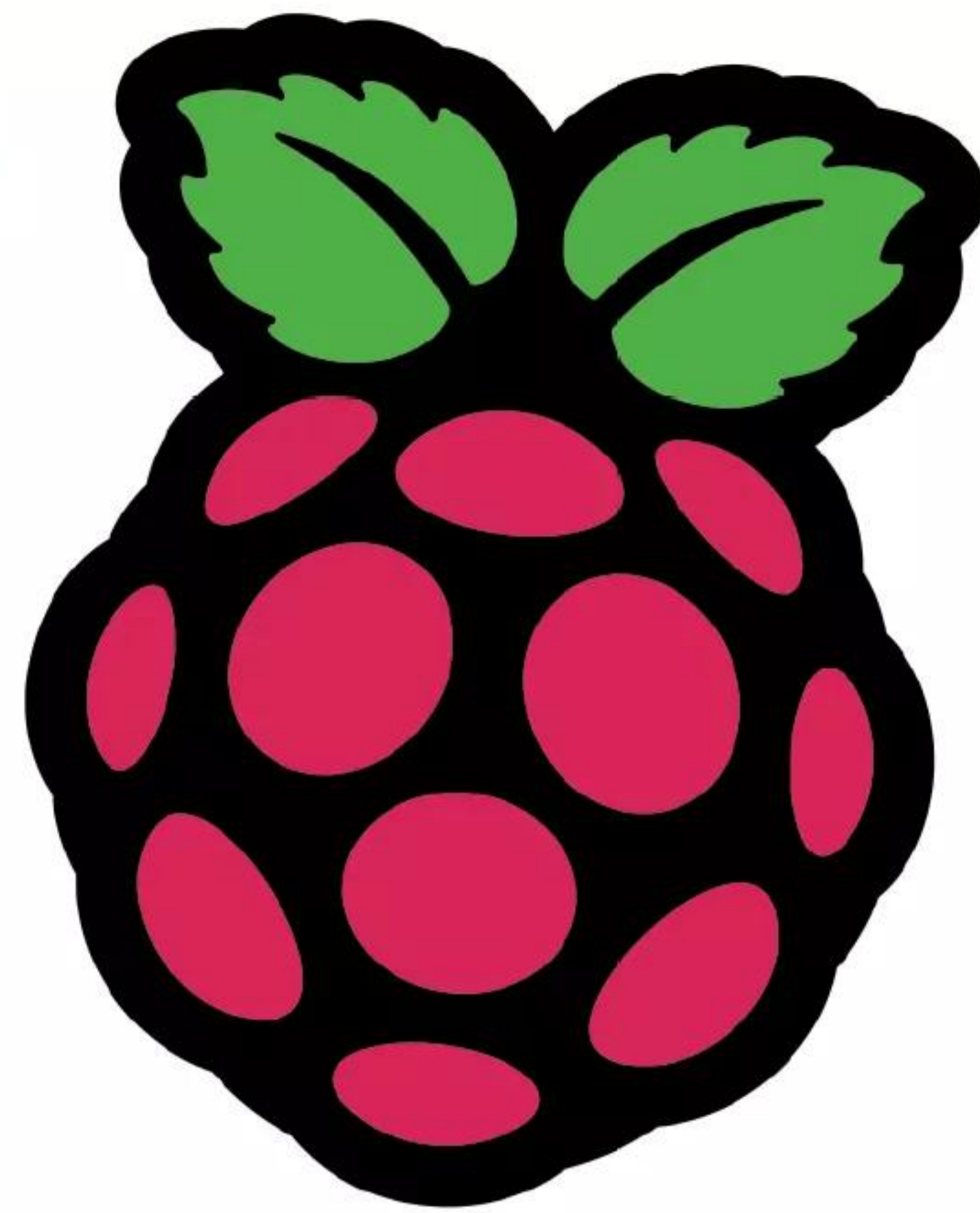

+ HackSpace

Issue 148 | December 2024 | magpi.cc

£7.99



9 772051 998025

GEAR GUIDE

2025!

The best new kit for the year ahead

- This month**
- New features for Raspberry Pi OS*
 - Build a Jellyfin media server*
 - Write your own coding language*

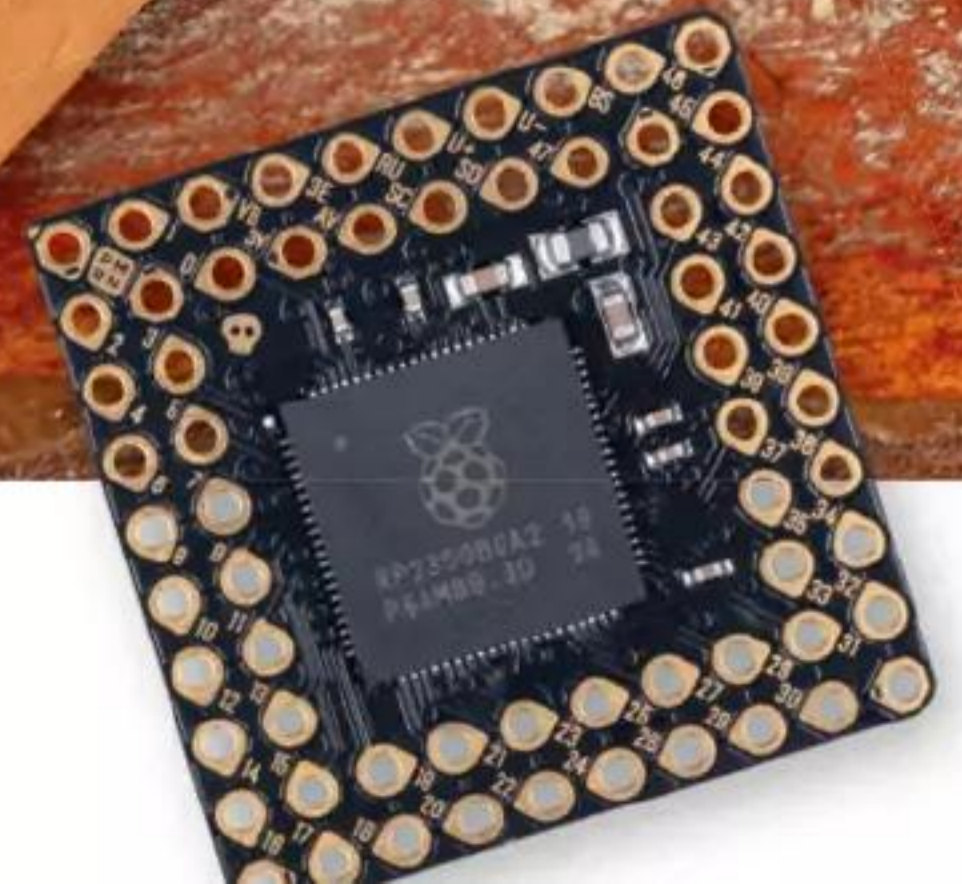
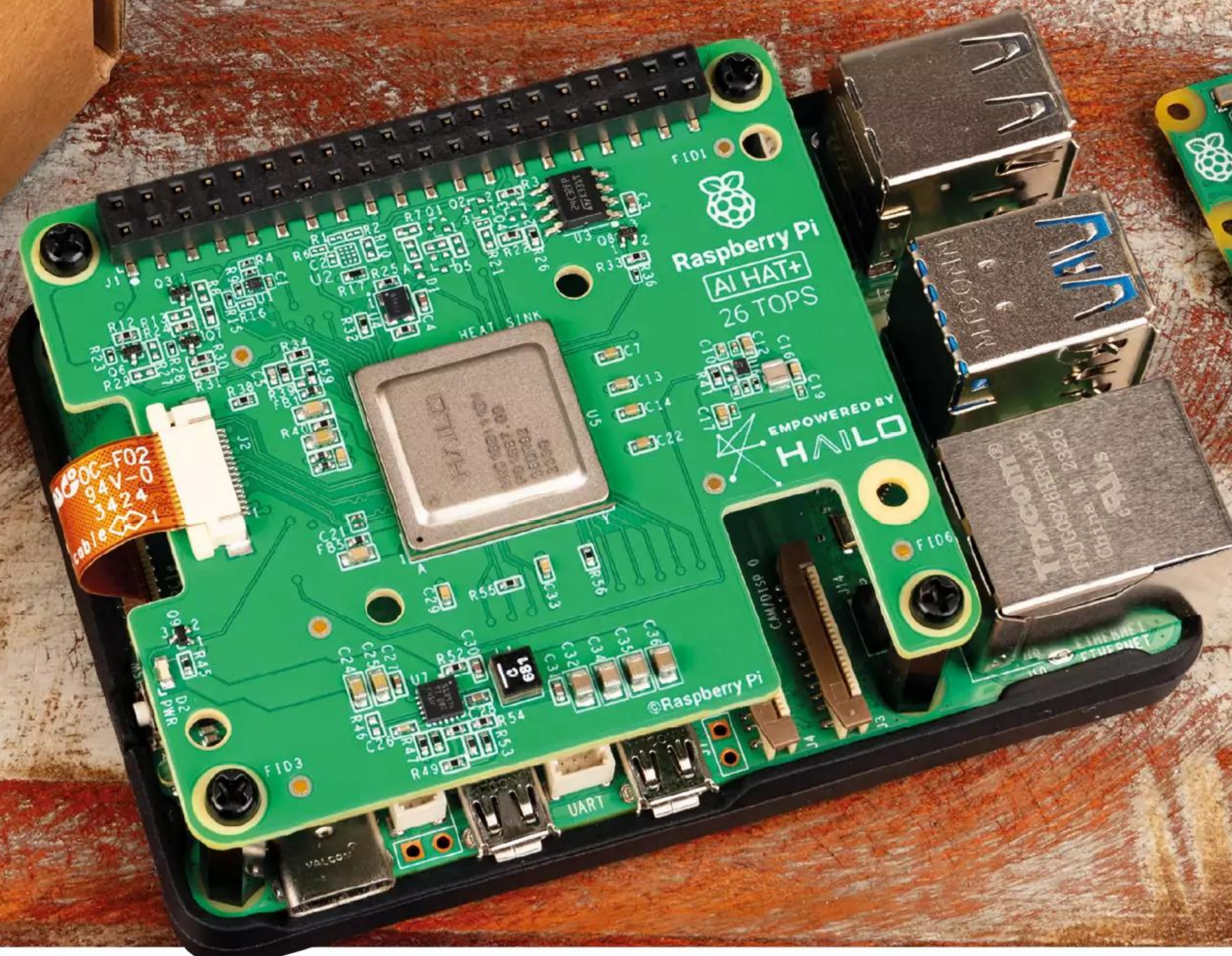
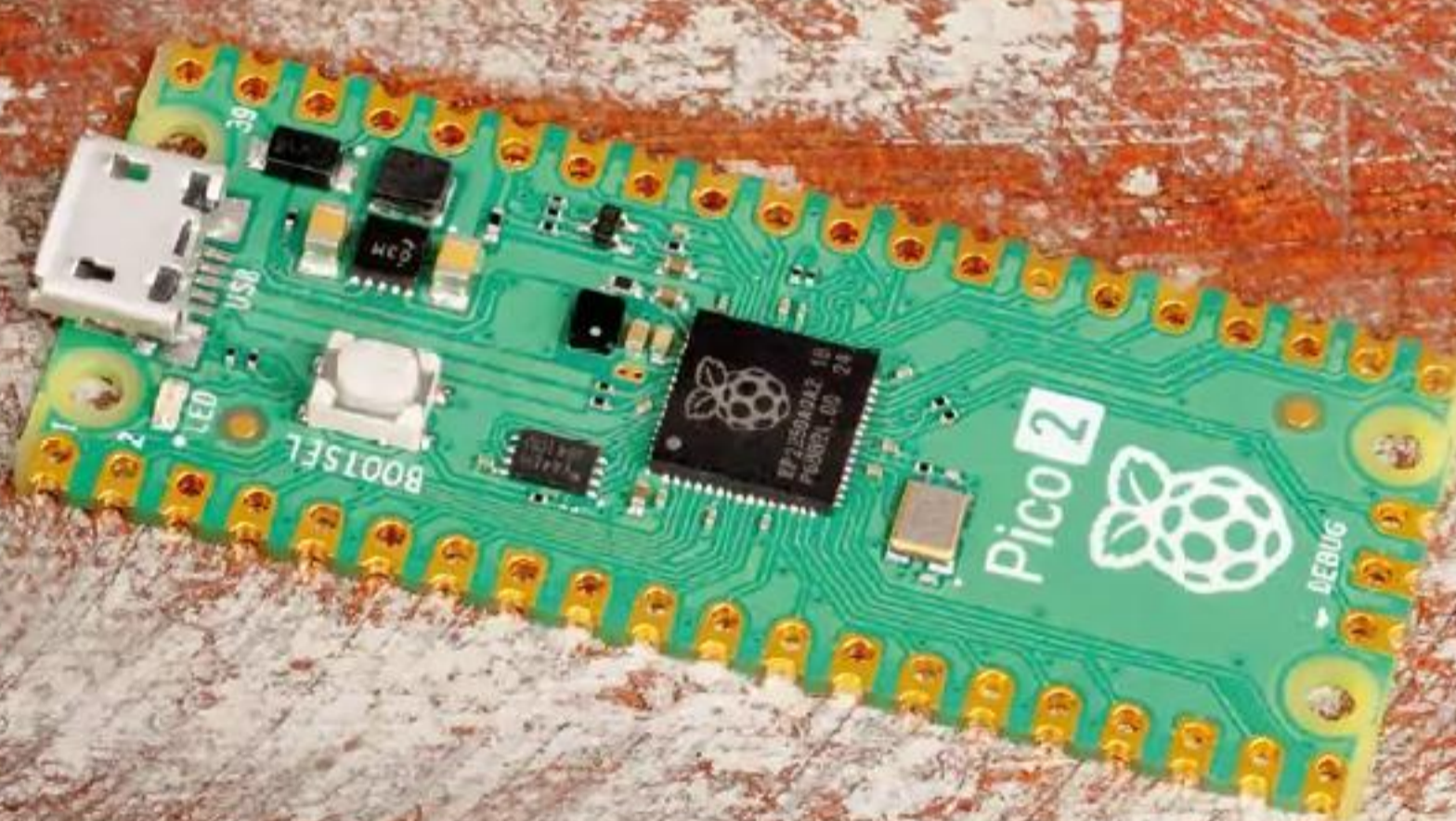

DISCOVER THE **BEST RP2350 HARDWARE**

Industrial Raspberry Pi **ComfilePi**

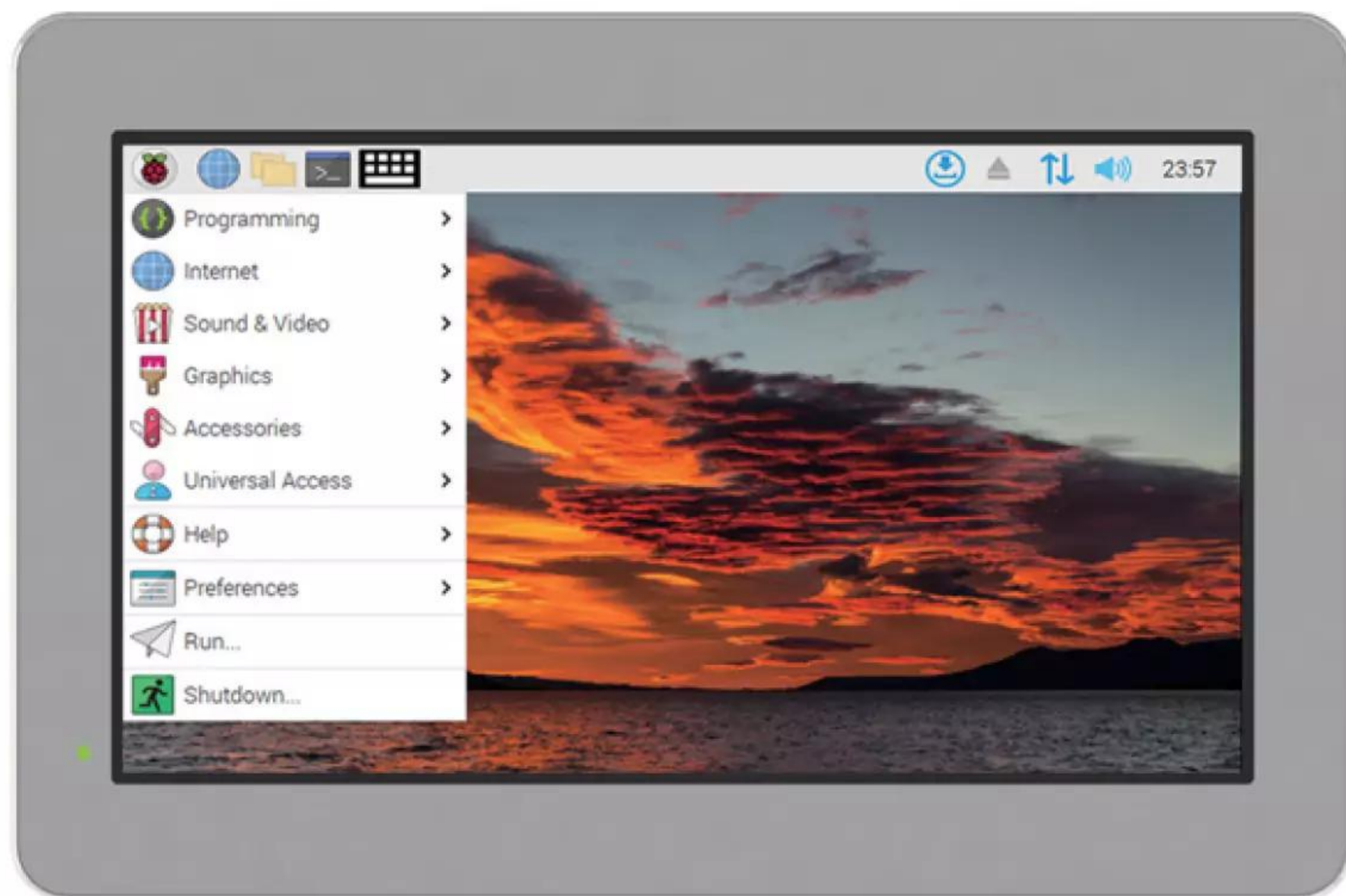

The ComfilePi is a touch panel PC designed with high-tolerant components and no moving parts for industrial applications. It features a water-resistant front panel, touchscreen, color LCD (available in various sizes), RS-232, RS-485, Ethernet, USB, I2C, SPI, digital IO, battery-backed RTC (real-time clock), and piezo buzzer.

Use the rear-panel 40-pin GPIO header to expand its features and capabilities with additional I/O boards. The ComfilePi is UL Listed and employs Raspberry Pi Compute Module.

Visit www.comfiletech.com

© copyright COMFILE Technology, Inc. ALL RIGHTS RESERVED

COMFILE
TECHNOLOGY

WELCOME

to The MagPi 148

Now is the best time to be an engineer, maker, or hobbyist interested in Raspberry Pi. There's an absolute cornucopia of Raspberry Pi riches to discover. Last month, we got the new AI Camera and the small (but surprisingly crowd-pleasing) Bumper. This month we've got an AI HAT+, an official SSD kit, USB 3.0 Hub, and a new version of Raspberry Pi OS. All of this alongside the Raspberry Pi 5 and Pico 2 boards that make it all work.

We're big on making your own entertainment, but having so many maker options to choose from can be daunting: our Gear Guide 2025 feature shines a light on new Raspberry Pi products and equipment to use in your creative projects. With this exceptional range of kit you'll boost your engineering skills, complete new coding challenges, and create incredible things. There's never been a better time to get into Raspberry Pi. Here's to 2025!

Lucy Hattersley Editor



EDITOR

Lucy Hattersley

Lucy is editor of *The MagPi* and this month her smart scale is telling her to drink more water (a potential hack if ever she's seen one).

magpi.cc



GET A
**RASPBERRY PI
PICO W**
WITH A SUBSCRIPTION!
PAGE 36

The parts we sell help us reach for the stars

Since first venturing beyond the safety of a cave, we have been natural explorers. Discovering what's beyond the next hill, horizon, and star, is a drive that is innately us.

The parts and services we provide help fuel the next era of exploration, and like you, we can't wait to see what's out there.



Discover millions of parts at [digikey.co.uk](https://www.digikey.co.uk)

DigiKey

we get technical

DigiKey is a franchised distributor for all supplier partners. New products added daily. DigiKey and DigiKey Electronics are registered trademarks of DigiKey Electronics in the U.S. and other countries. © 2024 DigiKey Electronics, 701 Brooks Ave. South, Thief River Falls, MN 56701, USA

ECIA MEMBER
Supporting The Authorized Channel

Contents

► Issue 148 ► December 2024

Cover Feature

38 Gear Guide 2025

Regulars

- 10 World of Raspberry Pi
- 64 Into HackSpace
- 122 Your letters
- 124 Community events calendar
- 129 Next month
- 130 The Final Word

Project Showcases

- 20 Fably
- 24 CatBot
- 26 Bumpin' Sticker
- 30 T-Rex Game Auto Jumper
- 32 Wax

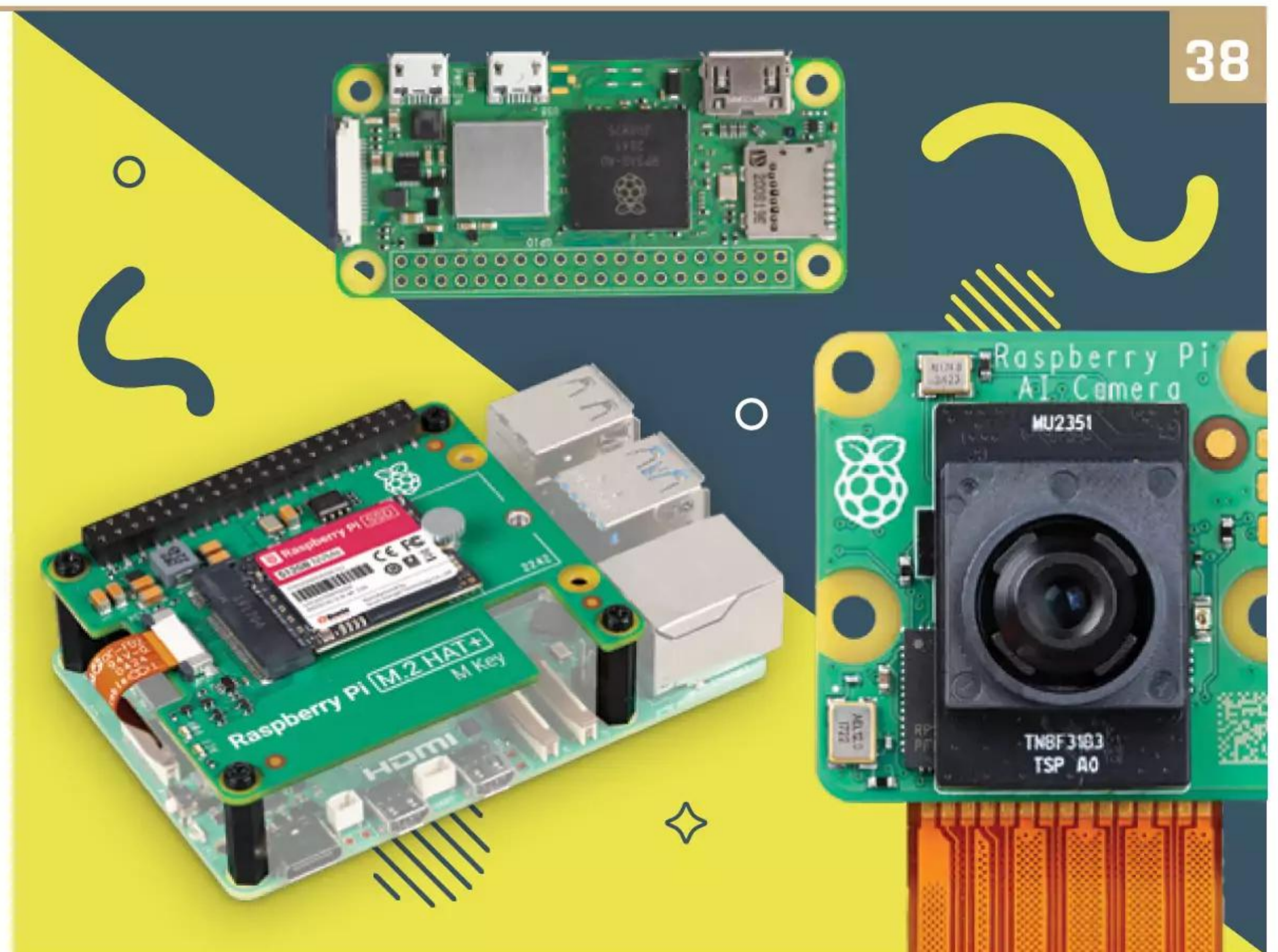

38

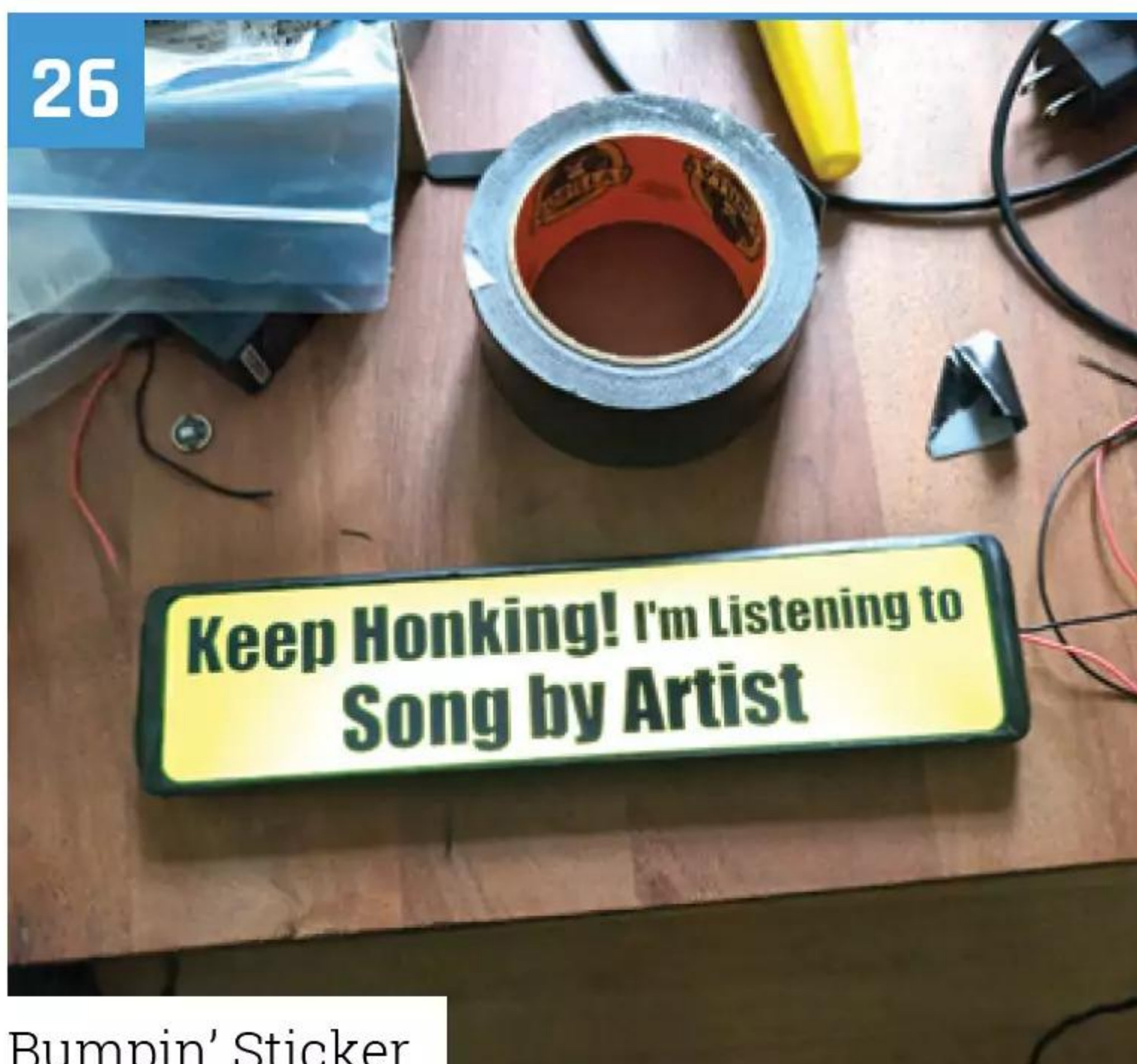

Bumpin' Sticker

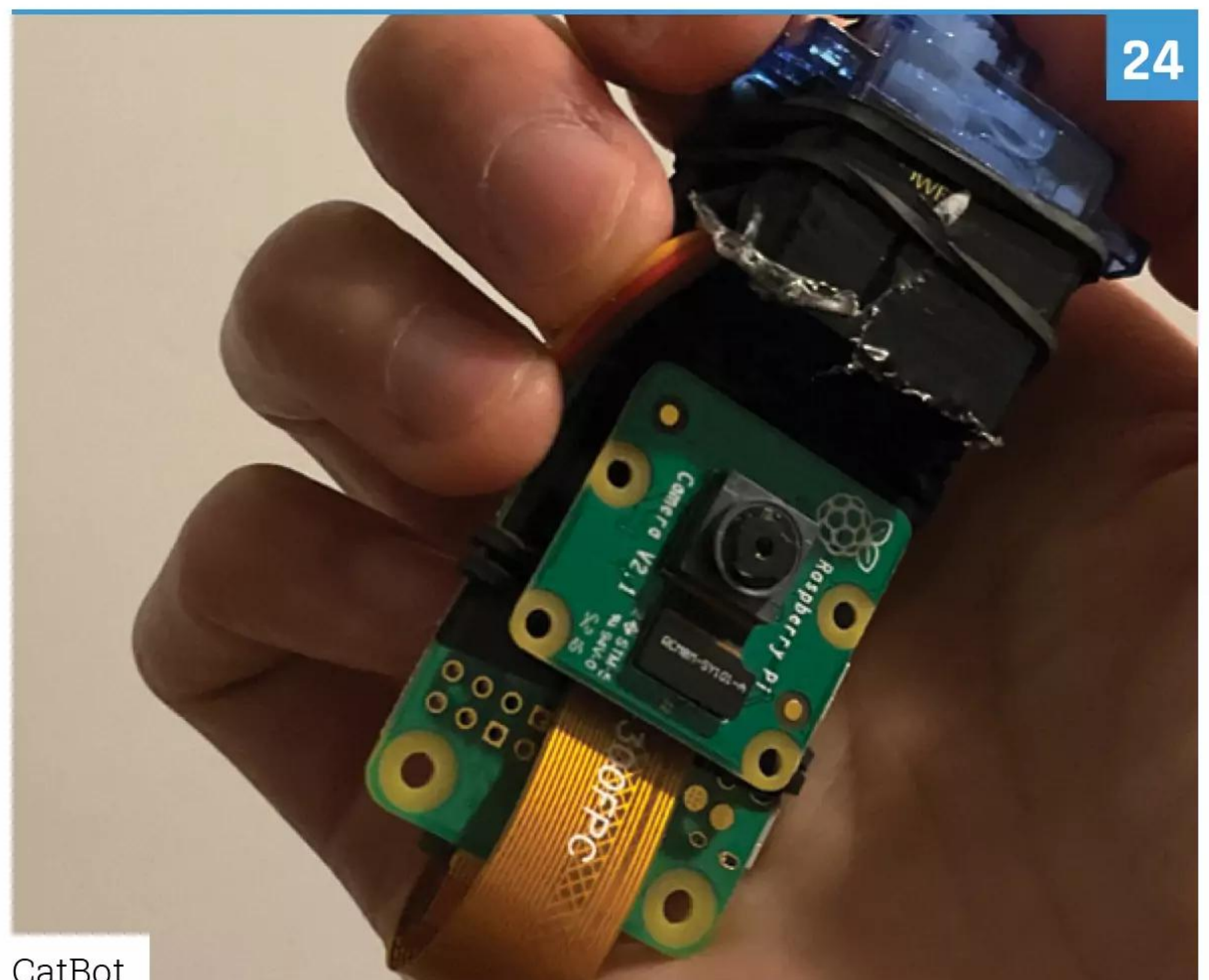

CatBot

24

The MagPi is published monthly by Raspberry Pi Ltd, 194 Cambridge Science Park, Milton Road, Cambridge, England, CB4 0AB. Publishers Service Associates, 2406 Reach Road, Williamsport, PA, 17701, is the mailing agent for copies distributed in the US and Canada. Periodicals Postage paid at Williamsport, PA. POSTMASTER: Send address changes to The MagPi, c/o Publishers Service Associates, 2406 Reach Road, Williamsport, PA, 17701.

Tutorials

- 48 Use Python virtual environments
- 52 Make a Jellyfin media server
- 58 Private cloud server - part 4

Top Projects

- 66 Bluetooth bakelite headset
- 68 Gimbal clock
- 70 Pelican cyberdeck
- 72 Ouija robot
- 74 Rotating art gallery

Forge

- 80 Build Pico software-defined radio
- 84 Write a software language
- 88 Create string art

Objet 3d'art



Robot hand

Best of Breed



RP2350 Boards

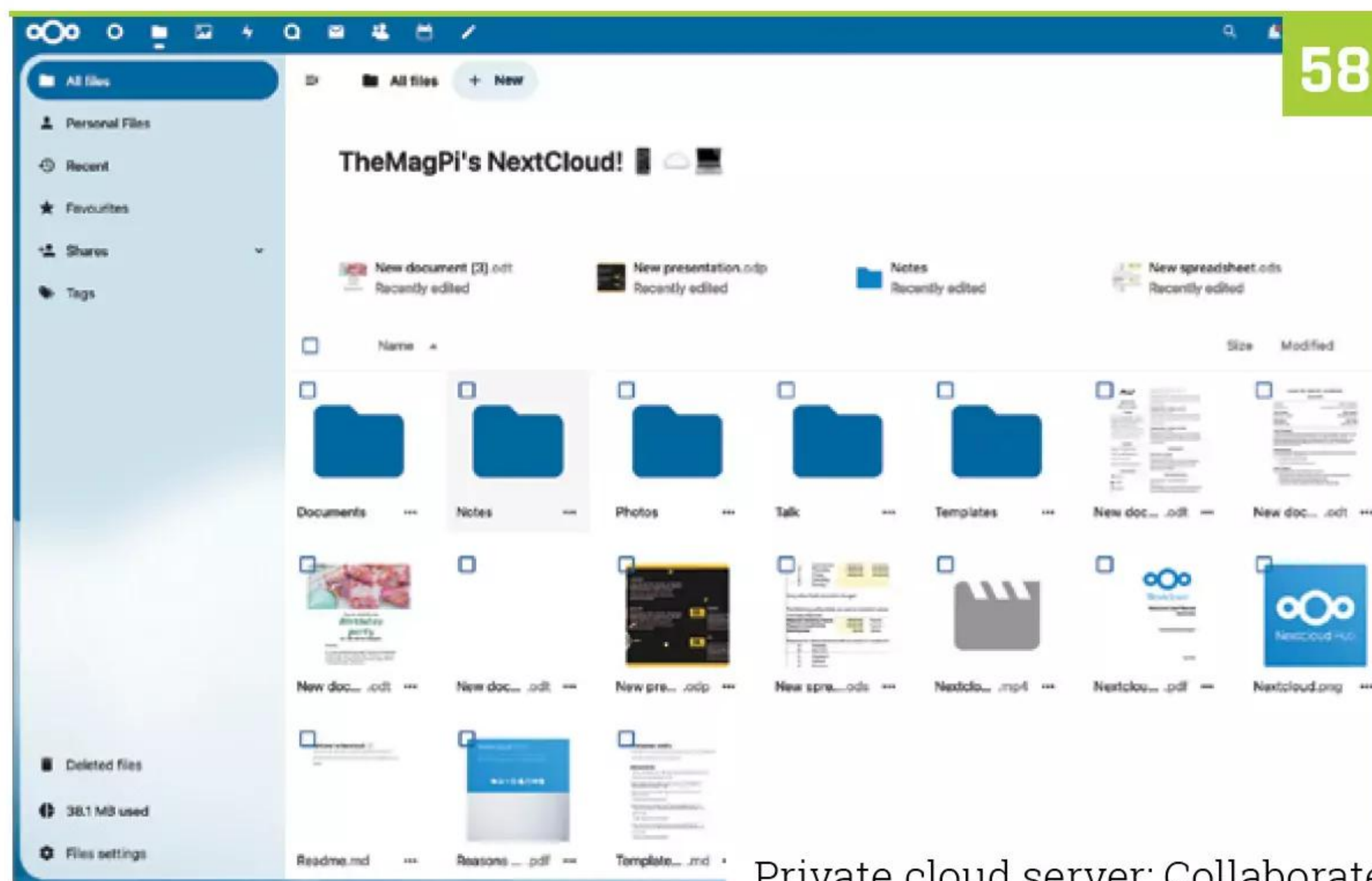

Private cloud server: Collaborate



Pelican cyberdeck

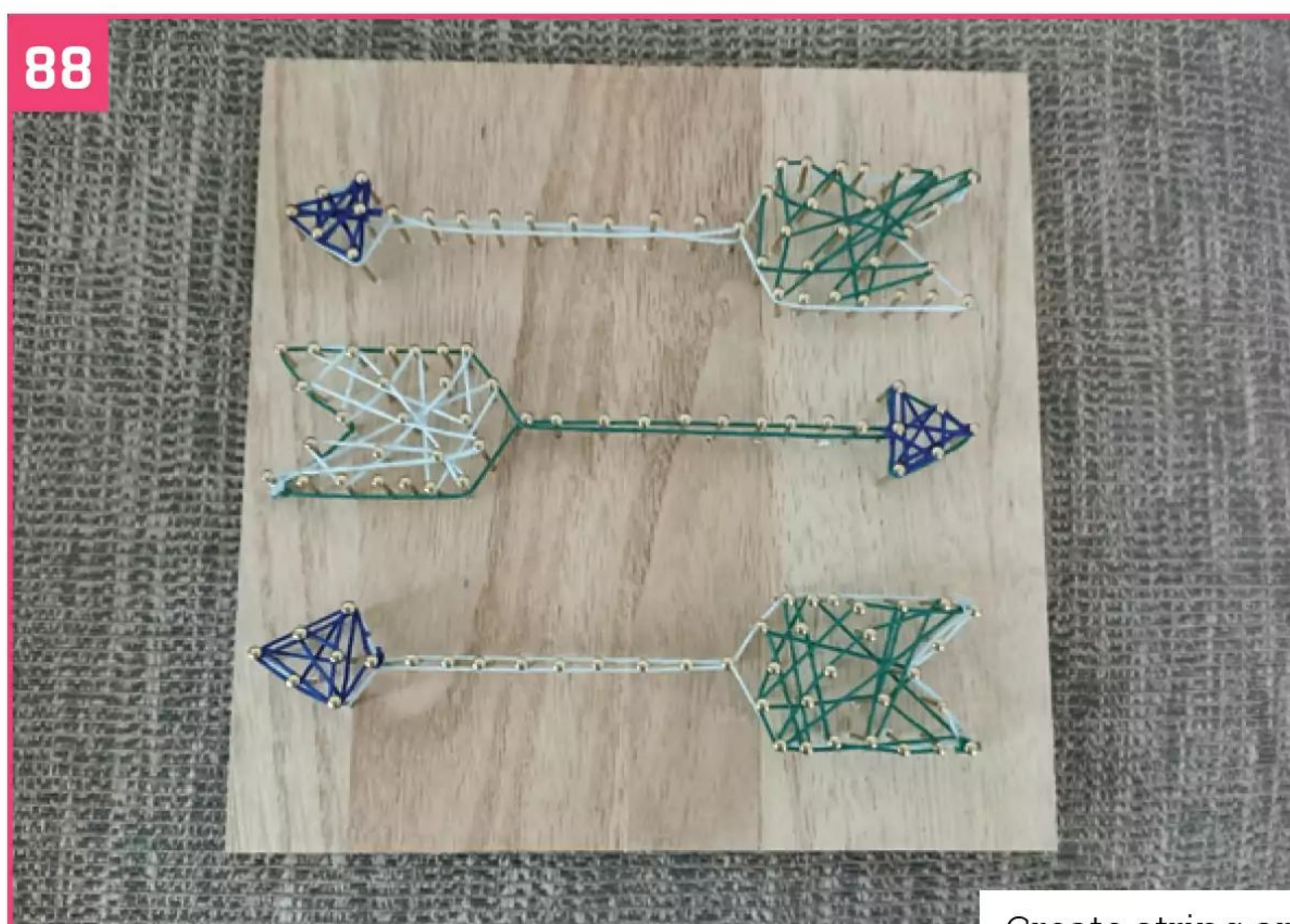

Create string art

EMPOWERING AI INNOVATION, ONE PCB AT A TIME

In the rapidly advancing world of AI, precision and reliability are essential. PCBWay provides high-quality PCB prototyping, assembly, CNC machining, and 3D printing services to bring your AI-driven projects to life. From robotics to smart devices, we offer a complete solution to power your next AI breakthrough.

PCBWay

Precision PCBs



Perfect for the complex designs that drive AI hardware.

Rapid Prototyping



Fast turnaround times as 24 hours to keep your innovations on schedule.

Global Reach



No matter where your lab or workshop is, we'll get your boards to you quickly and affordably.

End-to-End Support



We're more than manufacturers; we sponsor and collaborate with AI developers, startups, and makerspaces worldwide.

Why Choose Us?

With PCBWay as your partner, you can focus on pushing the boundaries of AI, while we ensure your hardware is up to the challenge.

Start building the future of AI today!

Visit [PCBWay.com](https://www.pcbway.com) to discover how our PCBs can power your next AI innovation.

service@pcbway.com



www.pcbway.com



The Big Feature



100

Gift a project



112

Argon Poly+ 5

Reviews

- 106 PiDog
- 108 PCIe USB HAT
- 110 Rpi All-in-One
- 112 Argon Poly+ 5
- 114 10 amazing festive light builds

Community

- 118 This Month in Raspberry Pi

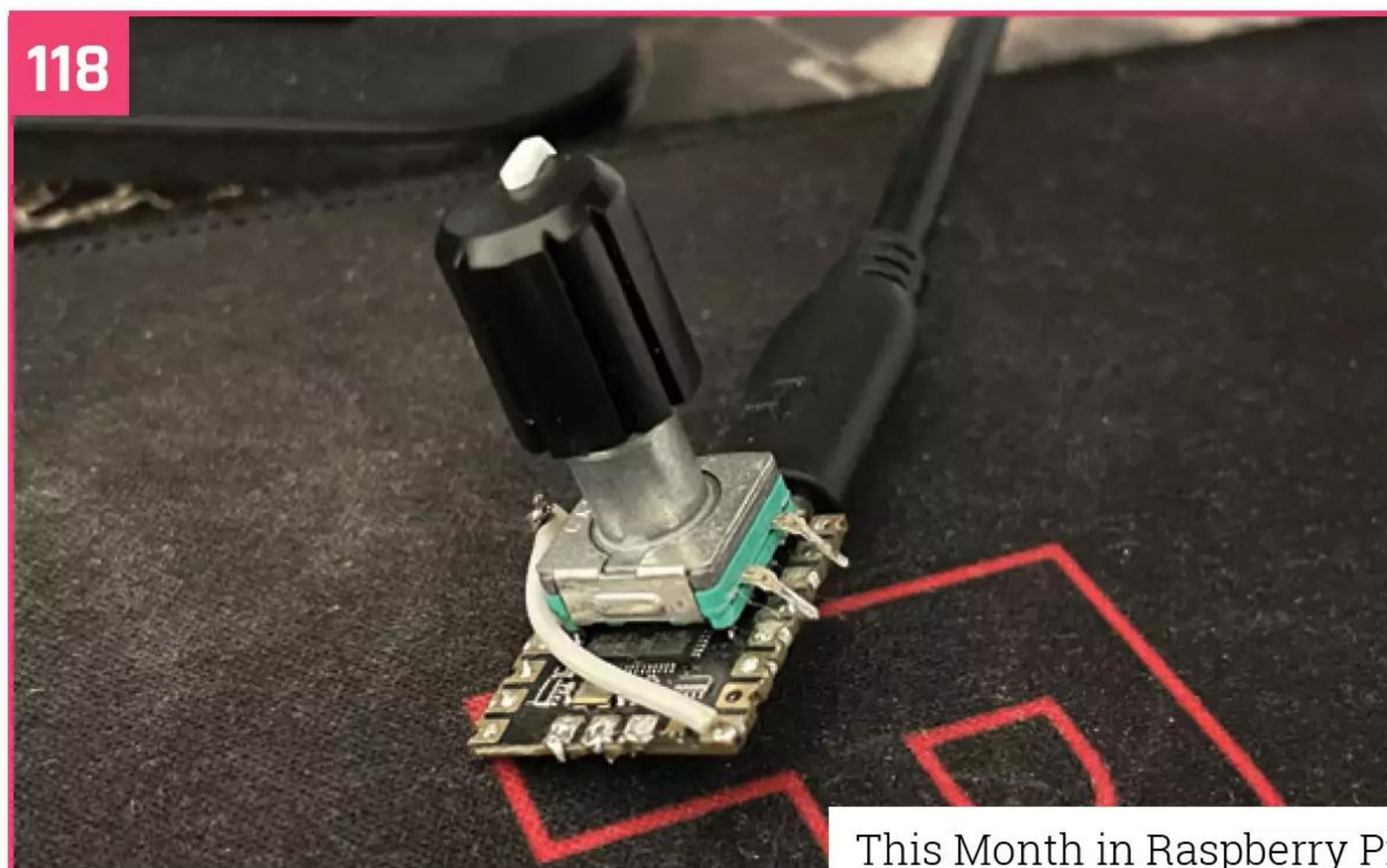

118

This Month in Raspberry Pi

WIN
1 OF 3

THUMBY COLOR



126

DISCLAIMER: Some of the tools and techniques shown in The MagPi magazine are dangerous unless used with skill, experience, and appropriate personal protection equipment. While we attempt to guide the reader, ultimately you are responsible for your own safety and understanding the limits of yourself and your equipment. Children should be supervised. Raspberry Pi Ltd does not accept responsibility for any injuries, damage to equipment, or costs incurred from projects, tutorials or suggestions in The MagPi magazine. Laws and regulations covering many of the topics in The MagPi magazine are different between countries, and are always subject to change. You are responsible for understanding the requirements in your jurisdiction and ensuring that you comply with them. Some manufacturers place limits on the use of their hardware which some projects or suggestions in The MagPi magazine may go beyond. It is your responsibility to understand the manufacturer's limits.

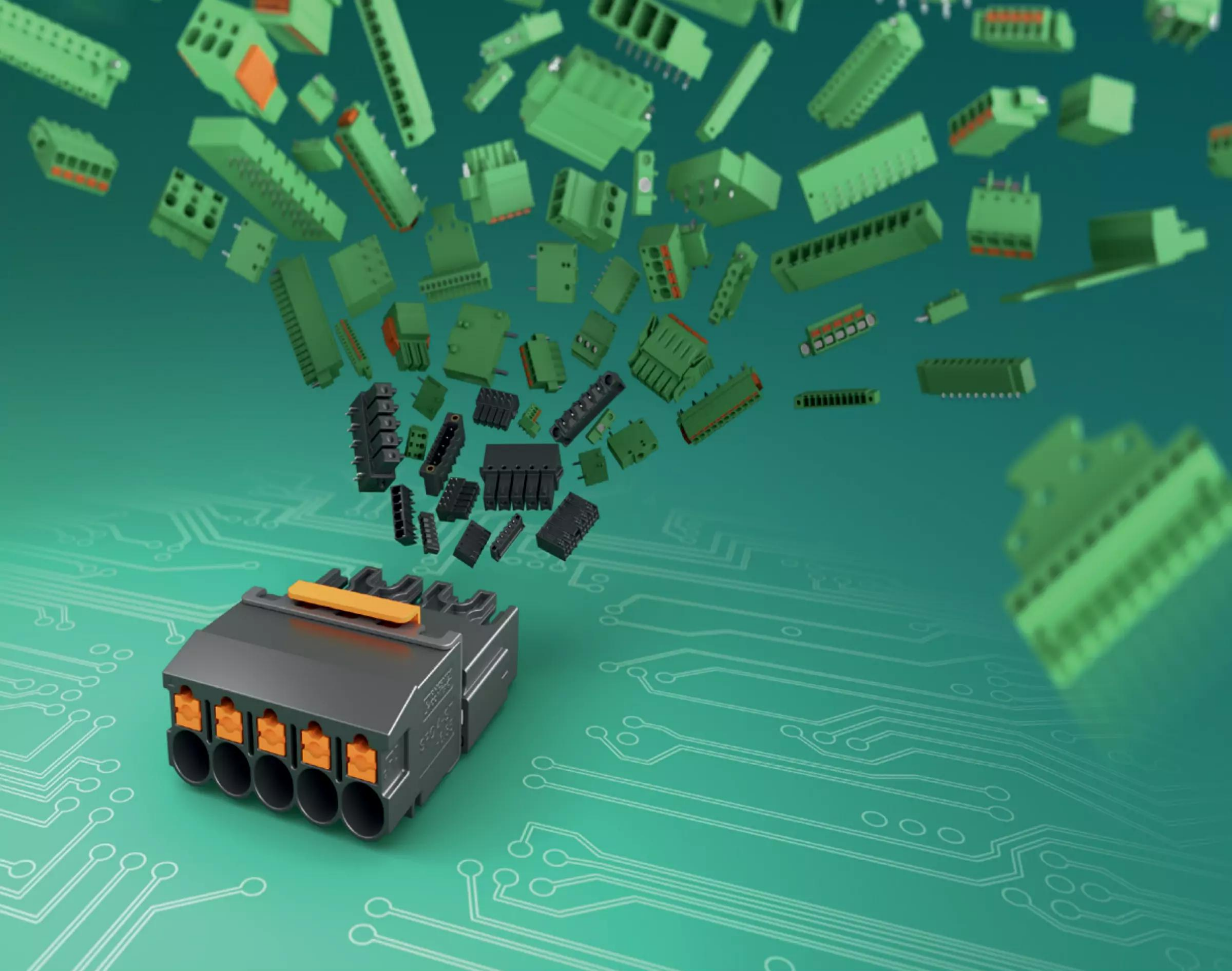

All the best combined in one connector

The new SPC 4 series PCB connectors

The everyday challenges our customers face are what drive us to continuously improve our products. The new SPC 4 series PCB connectors are the best proof that passionate engineering is indeed an art

For additional information, visit <https://phoe.co/uk-spc4>



Introducing Touch Display 2

Raspberry Pi Touch Display 2 on sale now at \$60

By **Eben Upton**



▲ Raspberry Pi Touch Display 2

Way back in 2015, we launched the Raspberry Pi Touch Display, a seven-inch 800×480-pixel LCD panel supporting multi-point capacitive touch. It remains one of our most popular accessories, finding a home in countless maker projects and embedded products.

We're excited to announce Raspberry Pi Touch Display 2 (magpi.cc/touchdisplay2), at the same low price of \$60 (£56), offering both a higher 720×1280-pixel resolution and a slimmer form factor.

Key features of Raspberry Pi Touch Display 2 include:

- Seven-inch diagonal display
- 88mm × 155mm active area
- 720 (RGB) × 1280 pixels
- True multi-touch capacitive panel, supporting five-finger touch
- Fully supported by Raspberry Pi OS
- Powered from the host Raspberry Pi

Simple setup

Touch Display 2 is powered from your Raspberry Pi, and is compatible with all Raspberry Pi computers from Raspberry Pi 1B+ onwards, except for the Raspberry Pi Zero series which lack the necessary DSI port. It attaches securely to your Raspberry Pi with four screws, and ships with power and data cables compatible with both standard and mini FPC connector formats. Unlike its predecessor, Touch Display 2 integrates the display driver PCB into the display enclosure itself, delivering a much slimmer form factor.

Like its predecessor, Touch Display 2 is fully supported by Raspberry Pi OS, which provides

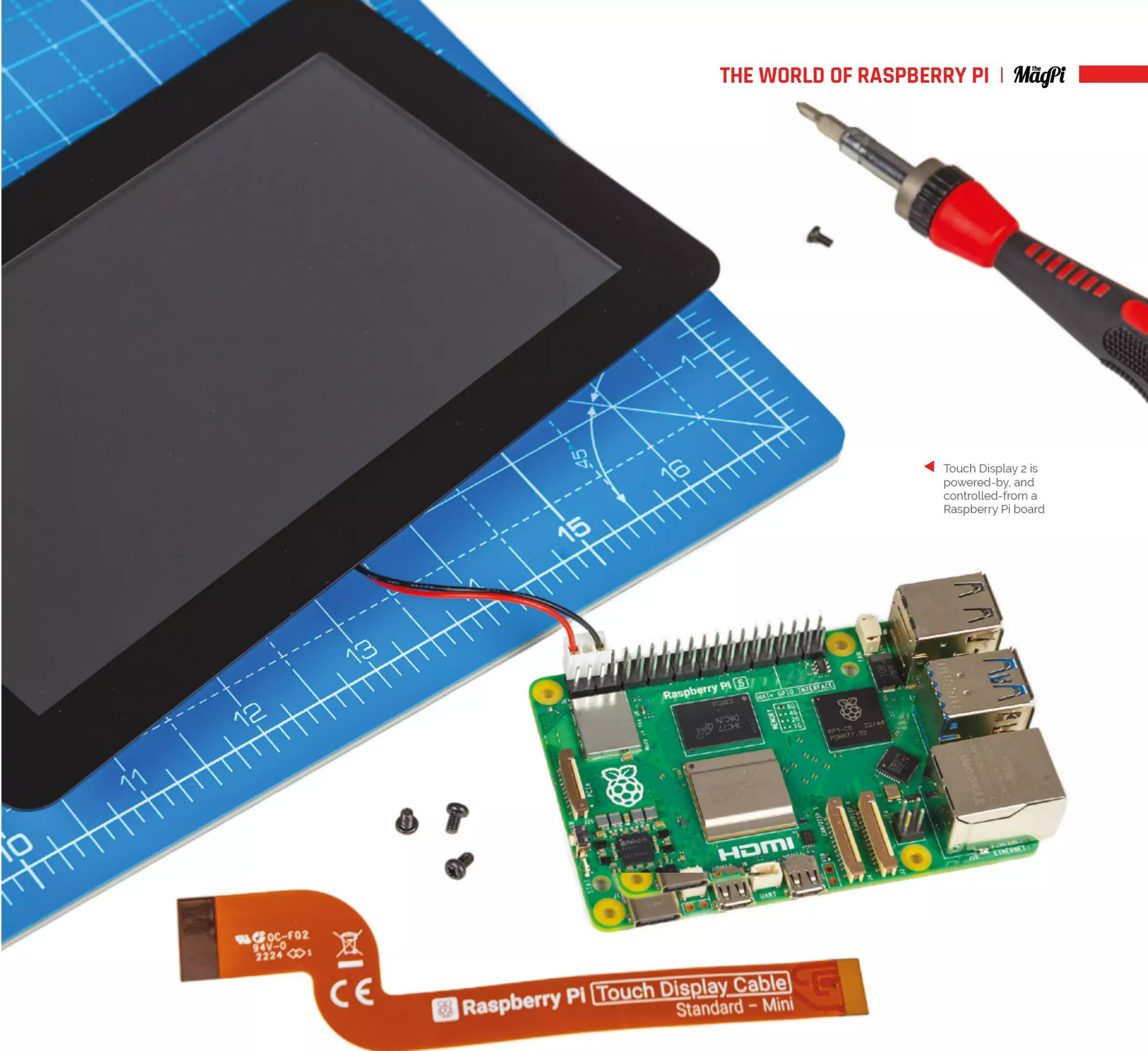

◀ Touch Display 2 is powered-by, and controlled-from a Raspberry Pi board

drivers to support five-finger touch and an on-screen keyboard. This gives you full functionality without the need for a keyboard or mouse. While it is a native portrait-format 720×1280-pixel panel, Raspberry Pi OS supports screen rotation for users who would prefer to use it in landscape orientation.

Consistent with our commitment to long product availability lifetimes, the original Touch Display will remain in production for the foreseeable future, though it is no longer recommended for new designs. Touch Display 2 will remain in production until 2030 at the earliest, allowing our embedded and industrial customers to build it into their products and installations with confidence.

“ Touch Display 2 is fully supported by Raspberry Pi OS, which provides drivers to support five-finger touch and an on-screen keyboard ”

We've never gone nine years between refreshes of a significant accessory before. But we took the time to get this one just right, and are looking forward to seeing how you use Touch Display 2 in your projects and products over the next nine years and beyond. *M*

A new release of Raspberry Pi OS

Introducing labwc - a new Wayland compositor. By **Simon Long**



Raspberry Pi is releasing a new version of Raspberry Pi OS. This version includes a significant change, albeit one that we hope most people won't even notice. So we thought we'd better tell you about it to make sure you do.

First, a brief history lesson. Linux desktops – like their Unix predecessors – have for many years used the X Window system. This is the underlying technology that displays the desktop, handles windows, moves the mouse, and all that other stuff that you don't really think about because it (usually) just works. X is prehistoric in computing terms, serving us well since the early '80s. But after 40 years, cracks are beginning to show in the design of X.

As a result, many Linux distributions are moving to a new windowing technology called Wayland. Wayland has many advantages over X, particularly performance. Under X, two separate applications help draw a window:

- The display server creates windows on the screen and gives applications a place to draw their content.
- The window manager positions windows relative to each other and decorates windows with title bars and frames.

Wayland combines these two functions into a single application called the compositor. Applications running on a Wayland system only need to talk to one thing, instead of two, to display a window. As you might imagine, this is a much more efficient way to draw application windows.

Wayland also provides a security advantage. Under X, all applications communicated back and forth with the display server; consequently, any application could observe any other application. Wayland isolates applications at the compositor level, so applications cannot observe each other.

We first started thinking about Wayland at Raspberry Pi around ten years ago; at that time, it was nowhere near ready to use. Over the last few years, we have taken cautious steps towards Wayland. When we released Bullseye back in 2021, we switched to a new X window manager, mutter, which could also be used as a Wayland compositor. We included the option to switch it to Wayland mode to see how it worked.

With the release of Bookworm in 2023, we replaced mutter with a new dedicated Wayland compositor called wayfire and made Wayland the default mode of operation for Raspberry Pi 4 and 5, while continuing to run X on lower-powered models. We spent a lot of time optimising wayfire



for Raspberry Pi hardware, but it still didn't run well enough on older Raspberry Pi computers, so we couldn't switch to it everywhere.

All of this was a learning experience – we learned more about Wayland, how it interacted with our hardware, and what we needed to do to get the best out of it. As we continued to work with wayfire, we realised it was developing in a direction that would make it less compatible with our hardware. At this point, we knew it wasn't the best choice to provide a good Wayland experience for Raspberry Pi. So we started looking at alternatives.

▲ Raspberry Pi OS has significantly improved support for touchscreens

“ We learned more about Wayland, how it interacted with our hardware, and what we needed to do to get the best out of it **”**

This search eventually led us to a compositor called labwc. Our initial experiments were encouraging: we were able to use it in Raspberry Pi OS after only a few hours of work. Closer investigation revealed labwc to be a much better fit for the Raspberry Pi graphics hardware than wayfire. We contacted the developers and found that their future direction very much aligned with our own.

The labwc compositor is built on top of a system called wlroots, a set of libraries which provide the basic functionality of a Wayland system. The wlroots system has been developed closely alongside the Wayland protocol. Using wlroots, anyone who wants to write a Wayland compositor doesn't need to reinvent the wheel; we can take advantage of the experience of those who designed Wayland, since they know it best.

So we made the decision to switch. For most of this year, we have been working on porting labwc to the Raspberry Pi desktop. This has very much been a collaborative process with the developers of both labwc and wlroots: both have helped us immensely with their support as we contribute

► The new raindrop screen configuration is written as native C and is faster and more maintainable than the old one

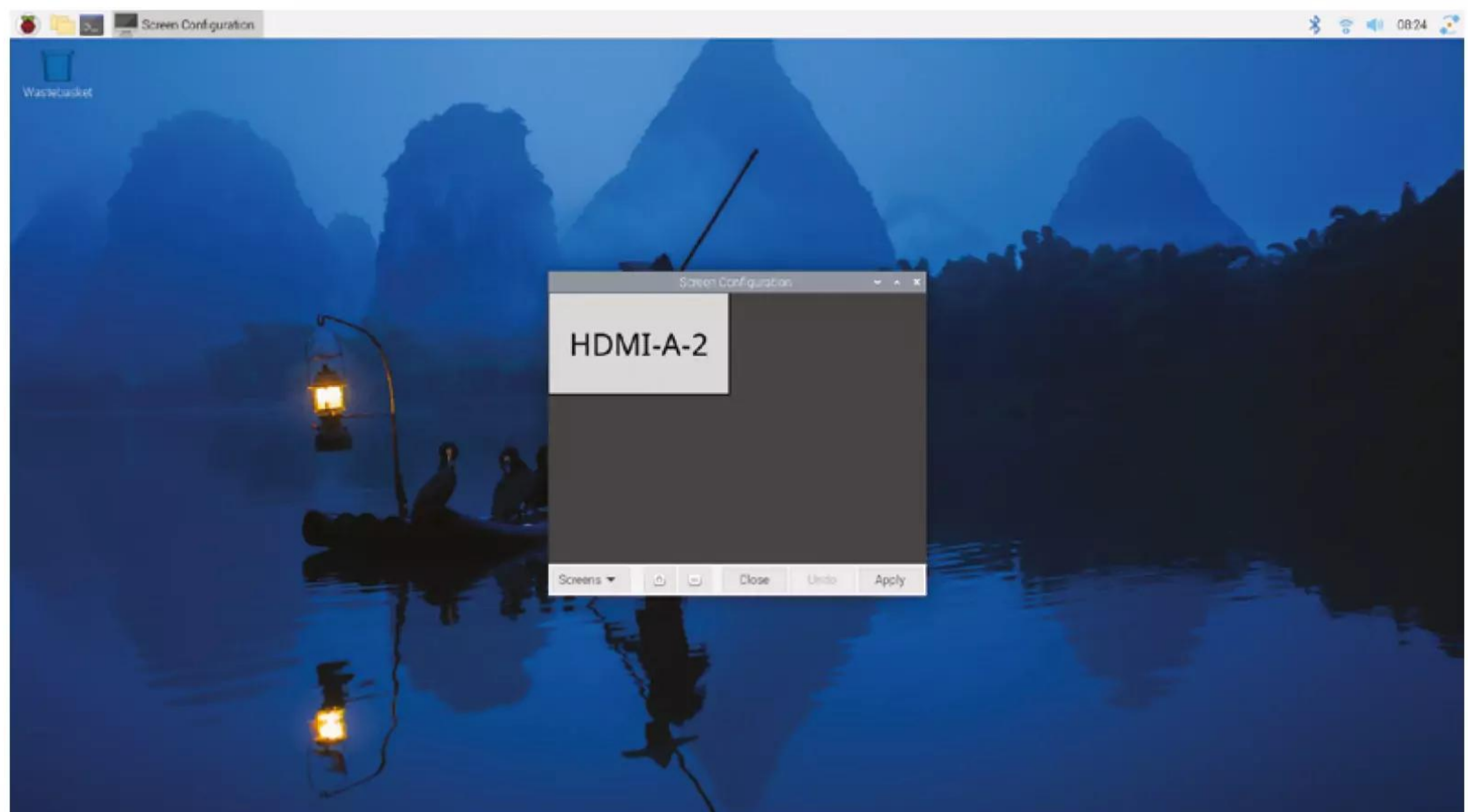

features and optimisations needed for our desktop. After much optimisation for our hardware, we have reached the point where labwc desktops run just as fast as X on older Raspberry Pi models. Today, we make the switch with our latest desktop image: Raspberry Pi Desktop now runs Wayland by default across all models.

When you update an existing installation of Bookworm, you will see a prompt asking to switch to labwc the next time you reboot. We recommend that most people switch to labwc.

Existing Raspberry Pi 4 or 5 Bookworm installations running wayfire shouldn't change in any noticeable way, besides the loss of a couple of animations which we haven't yet implemented in labwc. Because we will no longer support wayfire with updates on Raspberry Pi OS, it's best to adopt labwc as soon as possible.

Older Raspberry Pi computers that currently use X should also switch to labwc. To ensure backwards compatibility with older applications, labwc includes a library called Xwayland, which provides a virtual X implementation running on top of Wayland. The labwc compositor provides this virtual implementation automatically for any application that isn't compatible with Wayland. With Xwayland, you can continue to use older applications that you rely on while benefiting from the latest security and performance updates.

As with any software update, we cannot possibly test all possible configurations and applications. If you switch to labwc and experience an issue, you can always switch back to X. To do this, open a terminal window and type:

```
sudo raspi-config
```

This launches the command-line Raspberry Pi Configuration application. Use the arrow keys to select "6 Advanced Options" and hit Enter to open the menu. Select "A6 Wayland" and choose "W1 X11 Openbox window manager with X11 backend". Hit **ESCAPE** to exit the application; when you restart your device, your desktop should restart with X.

We don't expect this to be necessary for many people, but the option is there, just in case! Of course, if you prefer to stick with wayfire, or X, for any reason, the upgrade prompt offers you the option to do so – this is not a compulsory upgrade, just one that we recommend.

Improved touchscreen support

While labwc is the biggest change to the OS in this release, it's not the only one. We have also significantly improved support for using the Desktop with a touchscreen. Specifically, Raspberry Pi Desktop now includes a virtual keyboard and supports right-click and double-click equivalents for touch displays.

This change comes as a result of integrating the Squeekboard virtual keyboard. When the system detects a touch display, the virtual keyboard automatically displays at the bottom of the screen whenever it is possible to enter text. The keyboard also automatically hides when no text entry is possible.

This auto show-and-hide should work with most applications, but it isn't supported by everything. For applications which do not support it, you can instead use the keyboard icon at the right end of the taskbar to manually toggle the keyboard on and off.

If you don't want to use the virtual keyboard with a touchscreen, or you want to use it without a touchscreen and click on it with the mouse, you can

turn it on or off in the Display tab of Raspberry Pi Configuration. The new virtual keyboard only works with labwc; it's not compatible with wayfire or X.

In addition to the virtual keyboard, we added long-press detection on touchscreens to generate the equivalent of a right-click with a mouse. You can use this to launch context-sensitive menus anywhere in the taskbar and the file manager.

We also added double-tap detection on touchscreens to generate a double-click. While this previously worked on X, it didn't work in wayfire. Double-tap to double-click is now supported in labwc.

Better Raspberry Pi Connect integration

We've had a lot of very positive feedback about Raspberry Pi Connect, our remote access software that allows you to control your Raspberry Pi from any computer anywhere in the world. This release integrates Connect into the desktop.

By default, you will now see the Connect icon in the taskbar at all times. Previously, this indicated that Connect was running. Now, the icon indicates that Connect is installed and ready to use, but is not necessarily running. Hovering the mouse over the icon brings up a tooltip displaying the current status.

You can now enable or disable Connect directly from the menu which pops up when the icon is clicked. Previously, this was an option in Raspberry Pi Configuration, but that option has been removed. Now, all the options to control Connect live in the icon menu.

If you don't plan to use Connect, you can uninstall it from Recommended Software, or you can remove the icon from the taskbar by right-clicking the taskbar and choosing "Add / Remove Plugins...".

Other things

This release includes some other small changes worth mentioning:

- We rewrote the panel application for the taskbar at the top of the screen. In the previous version, even if you removed a plugin from the panel, it remained in memory. Now, when you remove a plugin, the panel never loads it into memory at all. Rather than all the individual plugins being part of a single application, each plugin is now a separate library. The panel only loads the libraries for the plugins that you choose to display on your screen. This won't make much difference to many people, but can save you a bit of RAM if you remove several plugins. This also makes it easier to develop new plugins, both for us

and third parties.

- We also introduced a new Screen Configuration tool, raindrop. This works exactly the same as the old version, arandr, and even looks similar. Under the hood, we rewrote the old application in C to improve support for labwc and touchscreens. Because the new tool is native, performance should be snappier! Going forward, we'll only maintain the new native version.

How to get it

The new release is available right now in apt, Raspberry Pi Imager, or as a download from the software page on [raspberrypi.com](https://www.raspberrypi.com).

To update an existing Raspberry Pi OS Bookworm installation to this release, run the following commands:

```
sudo apt update
sudo apt full-upgrade
```

When you next reboot, you will see the prompt described above which offers the switch to labwc.

To switch to the new Screen Configuration tool, run the following commands:

```
sudo apt purge arandr
sudo apt install raindrop
```

The new on-screen keyboard can either be installed from Recommended Software – it's called Squeekboard – or from the command line with:

```
sudo apt install squeekboard wfplug-squeek
```

We hope you like the new desktop experience. Or perhaps more accurately, we hope you won't notice much difference! 

▼ Switching from wayfire to labwc

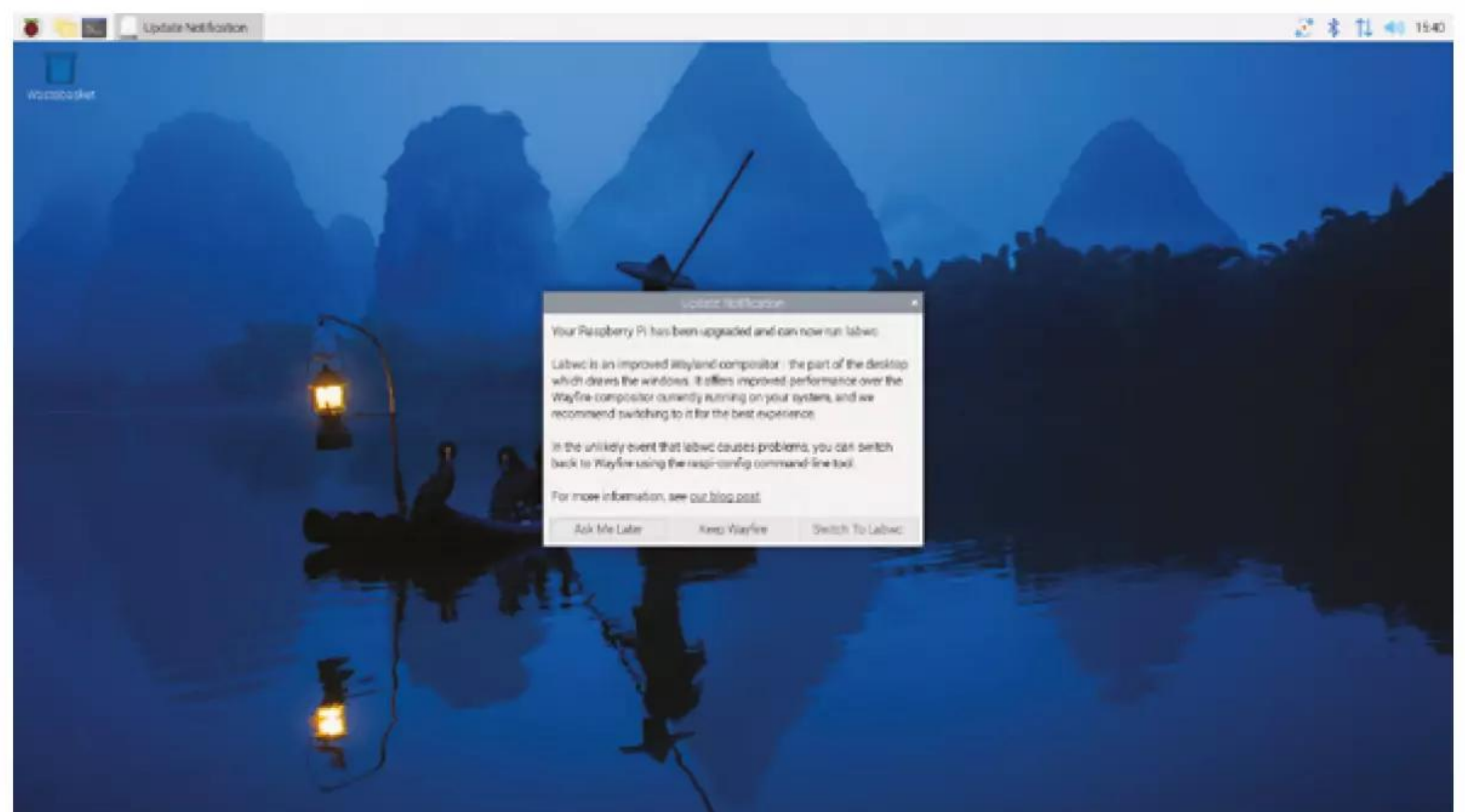

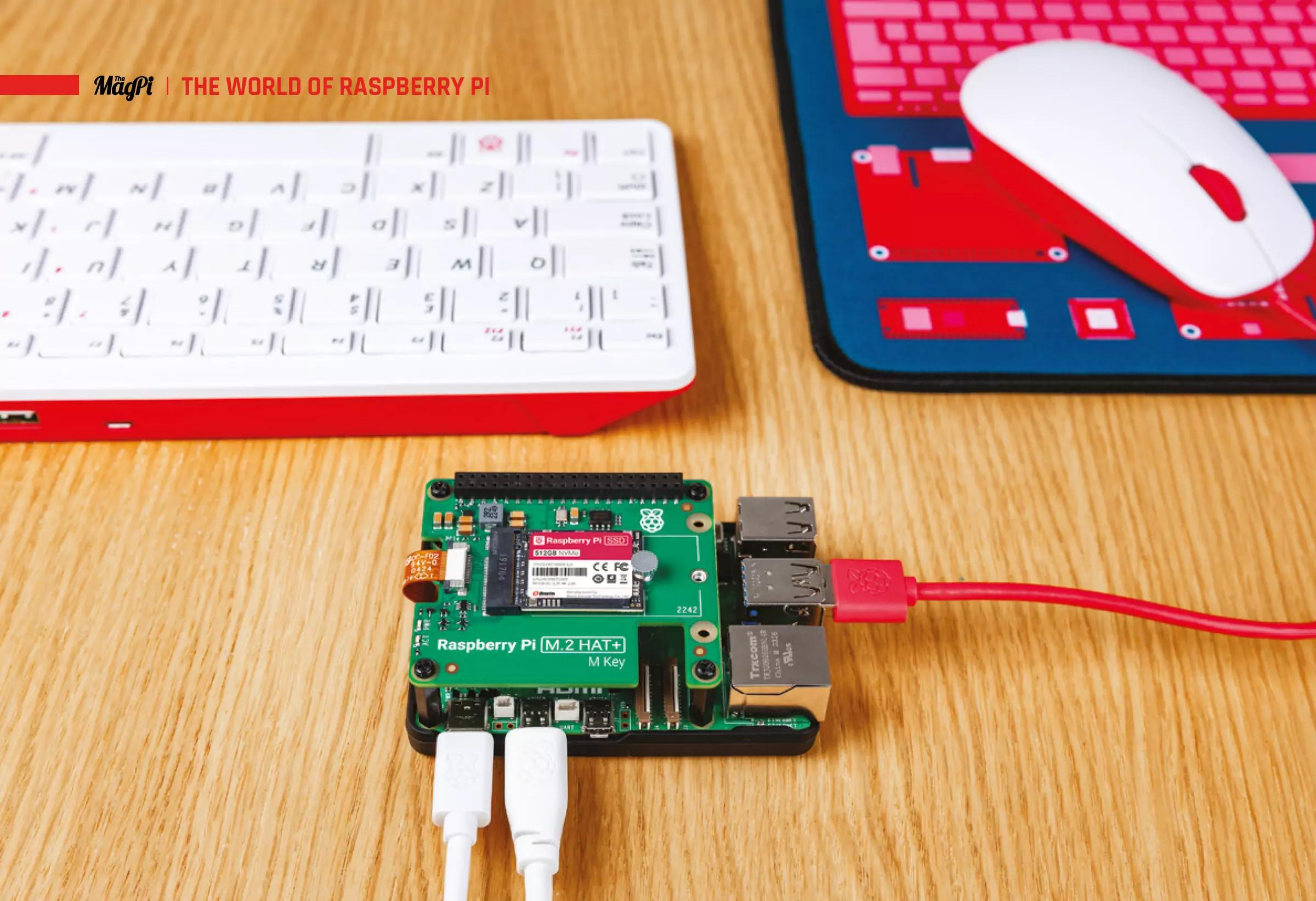

Raspberry Pi SSDs and SSD Kits

Raspberry Pi NVMe SSDs on sale now!

By **Eben Upton**

To help you get the best out of your Raspberry Pi 5, we're launching a range of Raspberry Pi-branded NVMe SSDs (non-volatile memory express, solid-state drives, magpi.cc/ssd). They are available both on their own and bundled with our M.2 HAT+ as ready-to-use SSD Kits (magpi.cc/ssdkit).

When we launched Raspberry Pi 5, almost exactly a year ago, I thought the thing people would get most excited about was the three-fold increase in performance over 2019's Raspberry Pi 4. But very quickly it became clear that it was the other new features – the power button

and the PCI Express port – that had captured people's imagination.

We've seen everything from Ethernet adapters, to AI accelerators, to regular PC graphics cards (magpi.cc/gpu4k) attached to the PCI Express port. We offer our own low-cost M.2 HAT+ (magpi.cc/m2hat), which converts from our FPC standard to the standard M.2 M-key format, and there are a wide variety of third-party adapters which do basically the same thing. We've also released an AI Kit (magpi.cc/aikit), which bundles the M.2 HAT+ with an AI inference accelerator from our friends at Hailo (hailo.ai).

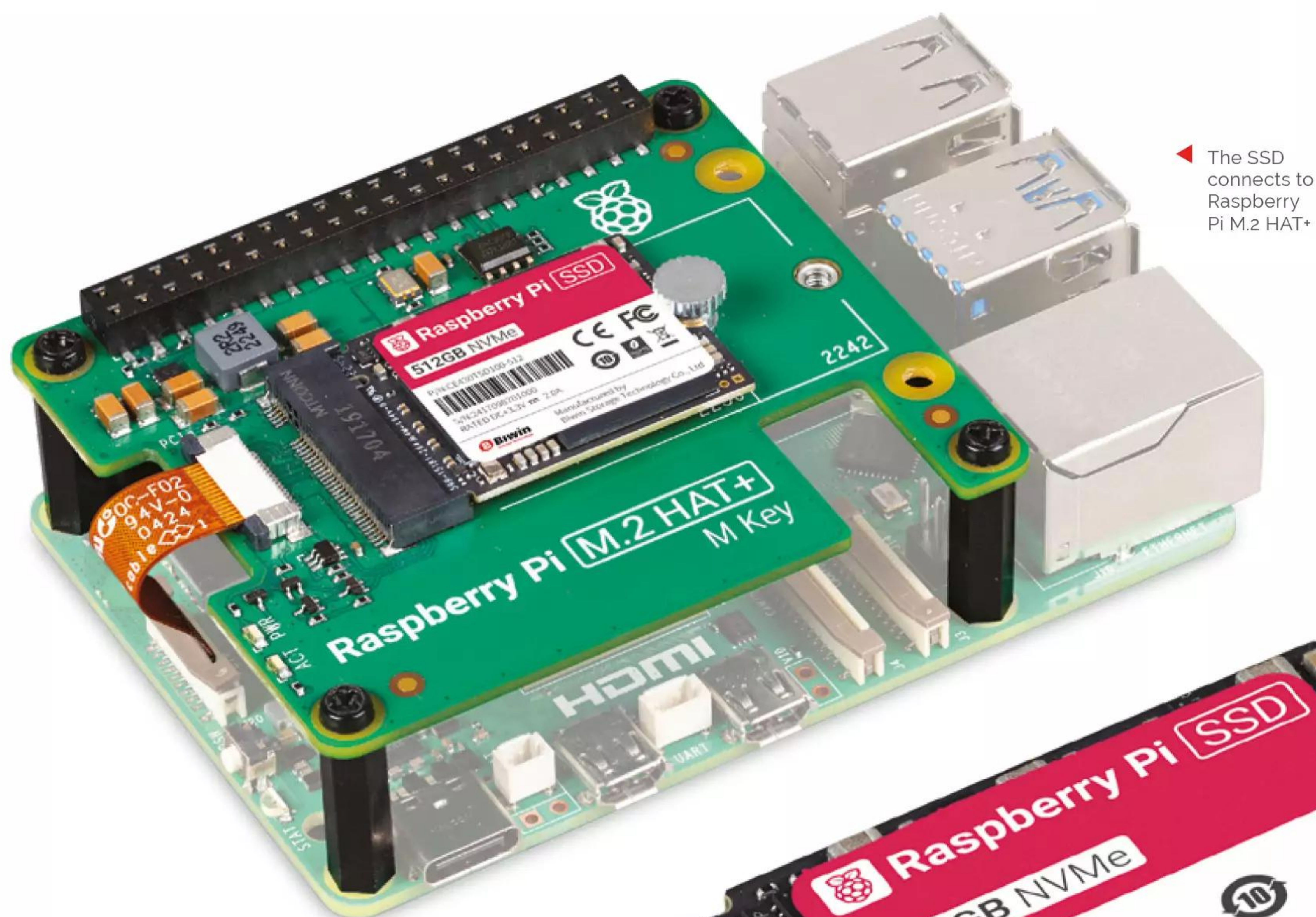

◀ The SSD connects to Raspberry Pi M.2 HAT+

“ A cost-effective way to squeeze even more performance out of your Raspberry Pi 5 ”



▲ Raspberry Pi SSD is a M.2 2230-format NVMe drive

PCI Express

But the most popular use case for the PCI Express port on Raspberry Pi 5 is to attach an NVMe solid-state disk (SSD). SSDs are fast; faster even than our branded A2-class SD cards (magpi.cc/sdcards). If no-compromises performance is your goal, you'll want to run Raspberry Pi OS from an SSD, and Raspberry Pi SSDs are the perfect choice.

The entry-level 256GB drive is priced at \$30 (£28) on its own, or \$40 (£40) as a kit; its 512GB big brother is priced at \$45 (£42) on its own, or \$55 (£51) as a kit. Both densities offer minimum 4KB random read and write performance of 40k IOPS and 70k IOPS respectively. The 256GB SSD and SSD Kit are available to buy today, while the 512GB variants are available to pre-order now for shipping by the end of November.

So, there you have it: a cost-effective way to squeeze even more performance out of your Raspberry Pi 5. Enjoy! 

Features

- ▶ M.2 2230-format NVMe SSD for Raspberry Pi
- ▶ Official Raspberry Pi SSD
- ▶ Compatible with Raspberry Pi 5 (when used with a compatible SSD HAT)
- ▶ Complies with PCIe Gen 3 standard
- ▶ NVMe 1.4 register interface and command set
- ▶ Individually packaged in anti-static bags
- ▶ Choice of 256GB or 512GB
- ▶ Reliable and fast storage or boot drive for your Raspberry Pi 5
- ▶ Operating temperature: 0 to 70 (ambient)
- ▶ Dimensions: 30mm x 22mm x 1.35mm (2230 format)

Introducing the Raspberry Pi AI HAT+

Integrated HAT+ with Hailo AI accelerator provides up to 26 TOPS. By **Naush Patuck**

Following the successful launch of the **Raspberry Pi AI Kit** (magpi.cc/aikit) and **AI Camera** (magpi.cc/aicamera), we are excited to introduce the newest addition to our AI product line: the **Raspberry Pi AI HAT+** (magpi.cc/aihat).

The AI HAT+ features the same best-in-class Hailo AI accelerator technology as our AI Kit, but now with a choice of two performance options: the 13 TOPS (tera-operations per second) model, priced at \$70 (£65) and

featuring the same Hailo-8L accelerator as the AI Kit, and the more powerful 26 TOPS model at \$110 (£102), equipped with the Hailo-8 accelerator.

Designed to conform to our HAT+ specification (magpi.cc/hatplusspec), the AI HAT+ switches automatically to PCIe Gen 3.0 (magpi.cc/pciegen3) mode to maximise the full 26 TOPS of compute power available in the Hailo-8 accelerator.

Direct connection

Unlike the AI Kit, which utilises an M.2 connector, the Hailo AI accelerator chip is directly integrated onto the main PCB.

This change not only simplifies setup but also offers improved thermal dissipation, allowing the AI HAT+ to handle demanding AI workloads more efficiently.

What can you do with the 26 TOPS model over the 13 TOPS model? The same, but more! You can run more sophisticated neural networks in real time, achieving better inference performance. The 26 TOPS model also allows you to run multiple networks simultaneously at high frame rates. For instance, you can perform object detection, pose estimation, and subject segmentation simultaneously on a live camera feed using the 26 TOPS AI HAT+.

You can see this in action via this Raspberry Pi YouTube demonstration: magpi.cc/aihatyt.

▼ Raspberry Pi AI HAT+ has an integrated Hailo AI accelerator providing up to 26 tera-operations per second

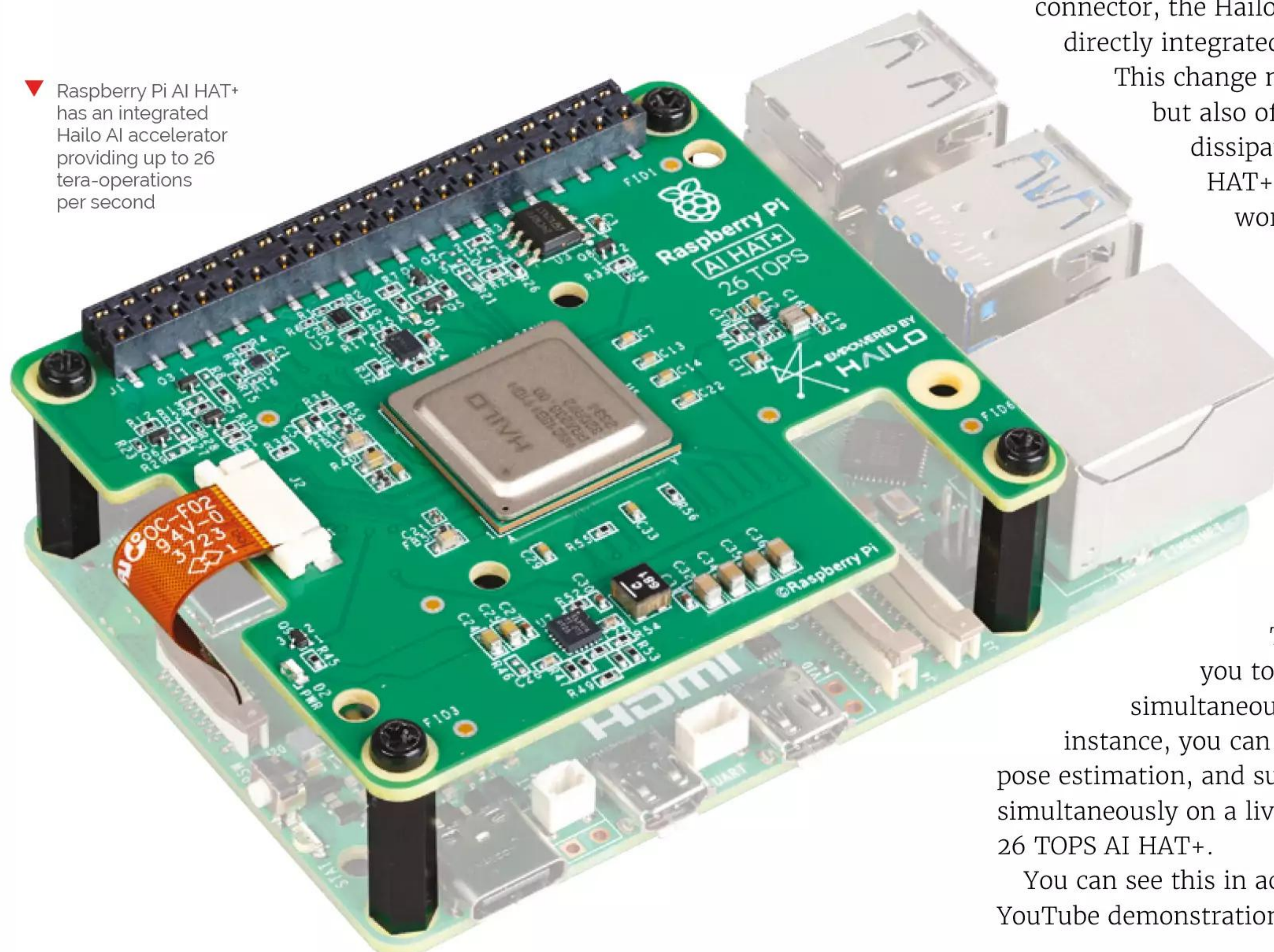

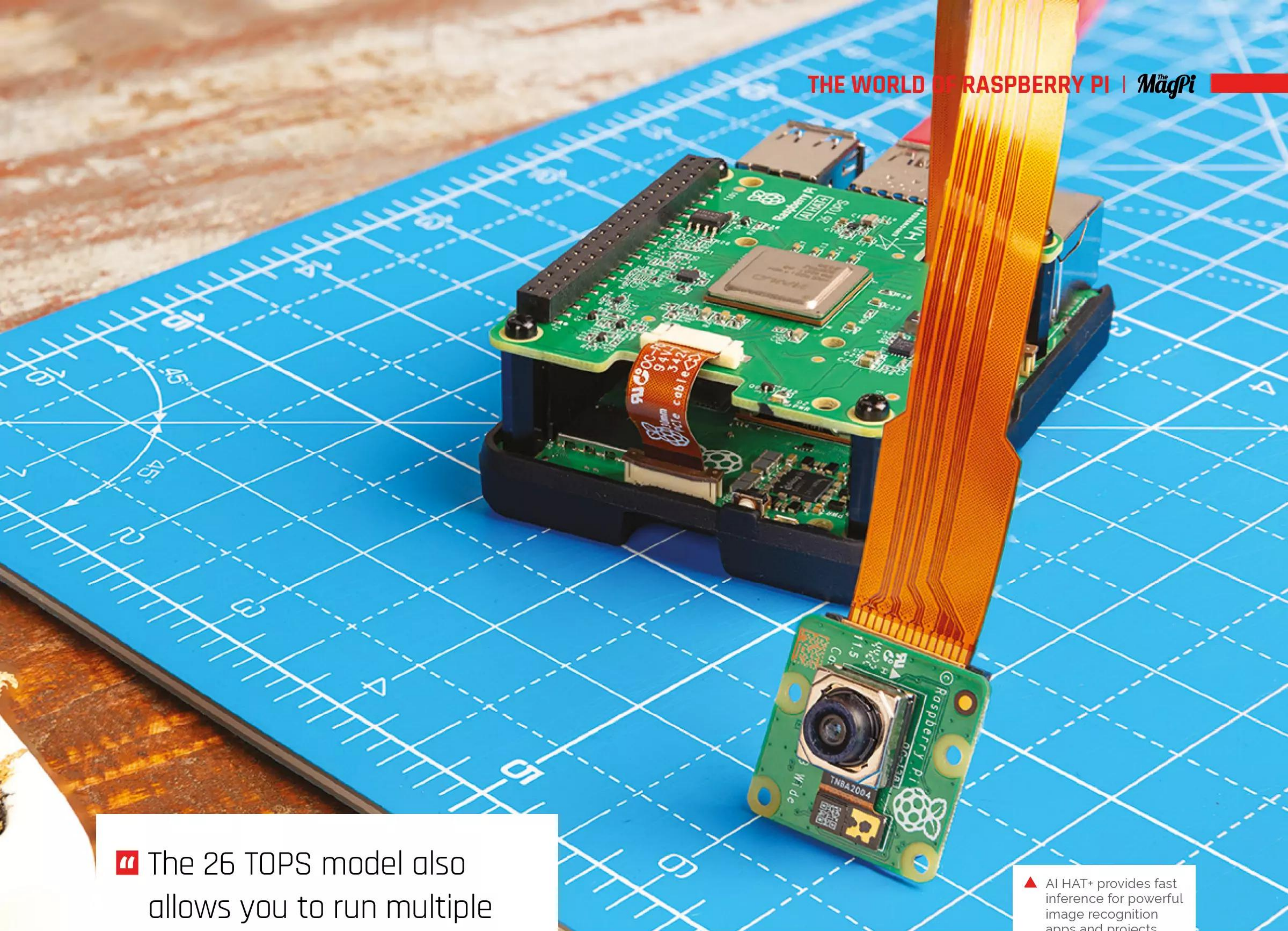

“ The 26 TOPS model also allows you to run multiple networks simultaneously at high frame rates ”

▲ AI HAT+ provides fast inference for powerful image recognition apps and projects

Backwards compatible

Both versions of the AI HAT+ are fully backwards compatible with the AI Kit. Our existing Hailo accelerator integration in the camera software stack works in exactly the same way with the AI HAT+. Any neural network model compiled for the Hailo-8L will run smoothly on the Hailo-8; while models specifically built for the Hailo-8 may not work on the Hailo-8L, alternative versions with lower performance are generally available, ensuring flexibility across different use cases.

After an exciting few months of AI product releases, we now offer an extensive range of options for running inferencing workloads on Raspberry Pi. Many such workloads – particularly those that are sparse, quantised, or intermittent – run natively on Raspberry Pi platforms; for more demanding workloads, we aim to be the best possible embedded host for accelerator hardware such as our AI Camera and today’s new Raspberry Pi AI HAT+. We are eager to discover what you make with it. 🍷

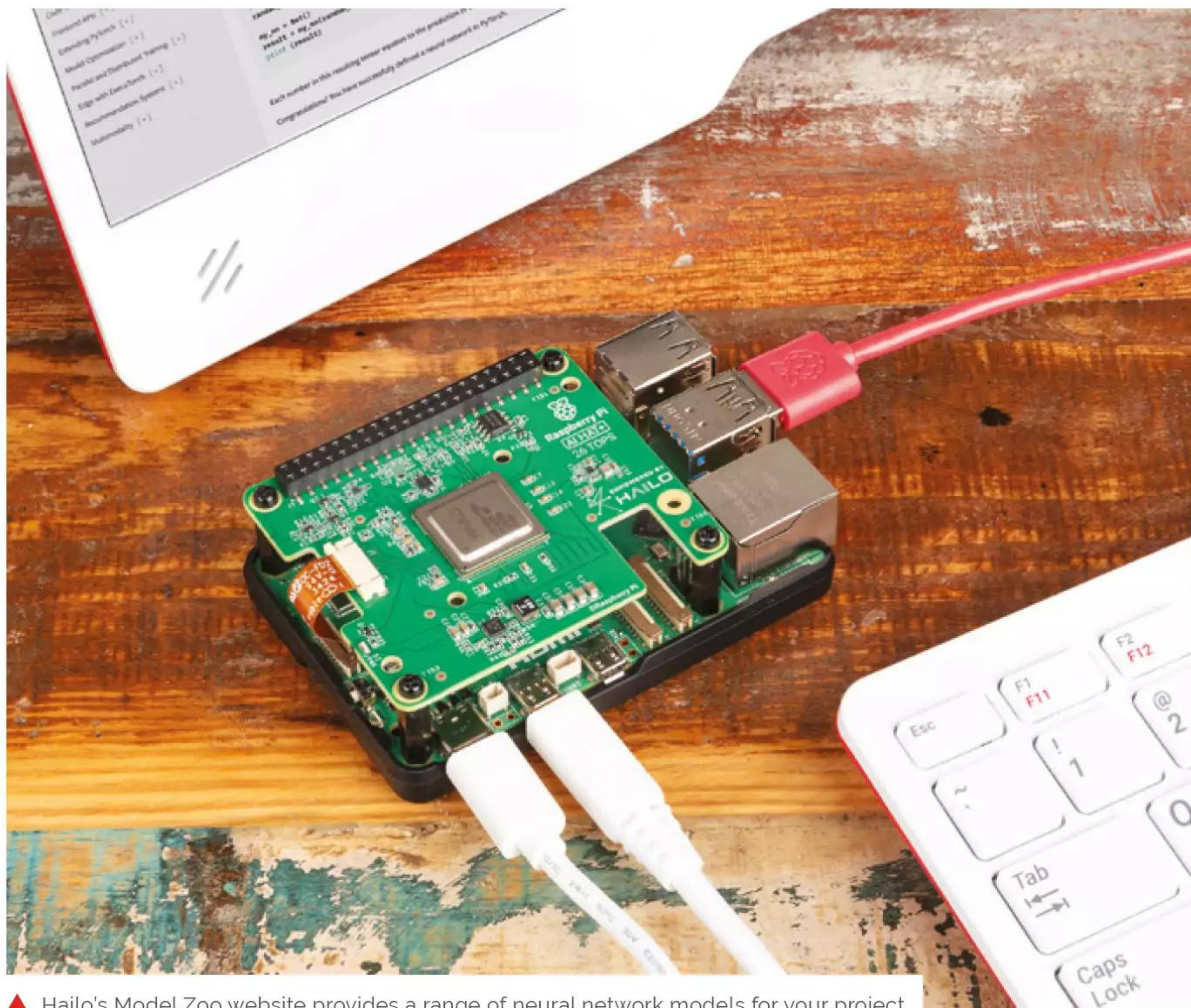

▲ Hailo’s Model Zoo website provides a range of neural network models for your project

Fably

Bedtime stories made up on the spot.
Rosie Hattersley spins an electronic yarn



MAKER

Stefano Mazzocchi

Electronics engineer Stefano says his “heart is in hardware”. Raspberry Pi deeply resonates with him, thanks to its focus on hardware, openness and the tinkering spirit

magpi.cc/fablygit

Once upon a time, there was a father called Stefano whose daughter hung on every word of his inventive night-time tales.

She loved the characters he conjured up and remembered each one with fondness. After a few years, Stefano found himself running out of new storylines with which to entertain his beloved child. He decided to look around for someone – or something – to rescue them both from having to go back over the same old stories. Having exhausted the big book of fabulous fables, Stefano invented a new way of creating tales,

using AI and Raspberry Pi. The project took many, many hours, and was done in secret in case it didn’t work out. Eventually, the new storyteller was complete and, one evening, Stefano shyly introduced Fably to his daughter.

Childhood wonder

Stefano’s first computer, a Commodore Vic20, was something he could program himself and opened up a world of possibilities. Most importantly, this first computer awakened Stefano to the idea of tinkering and eventually

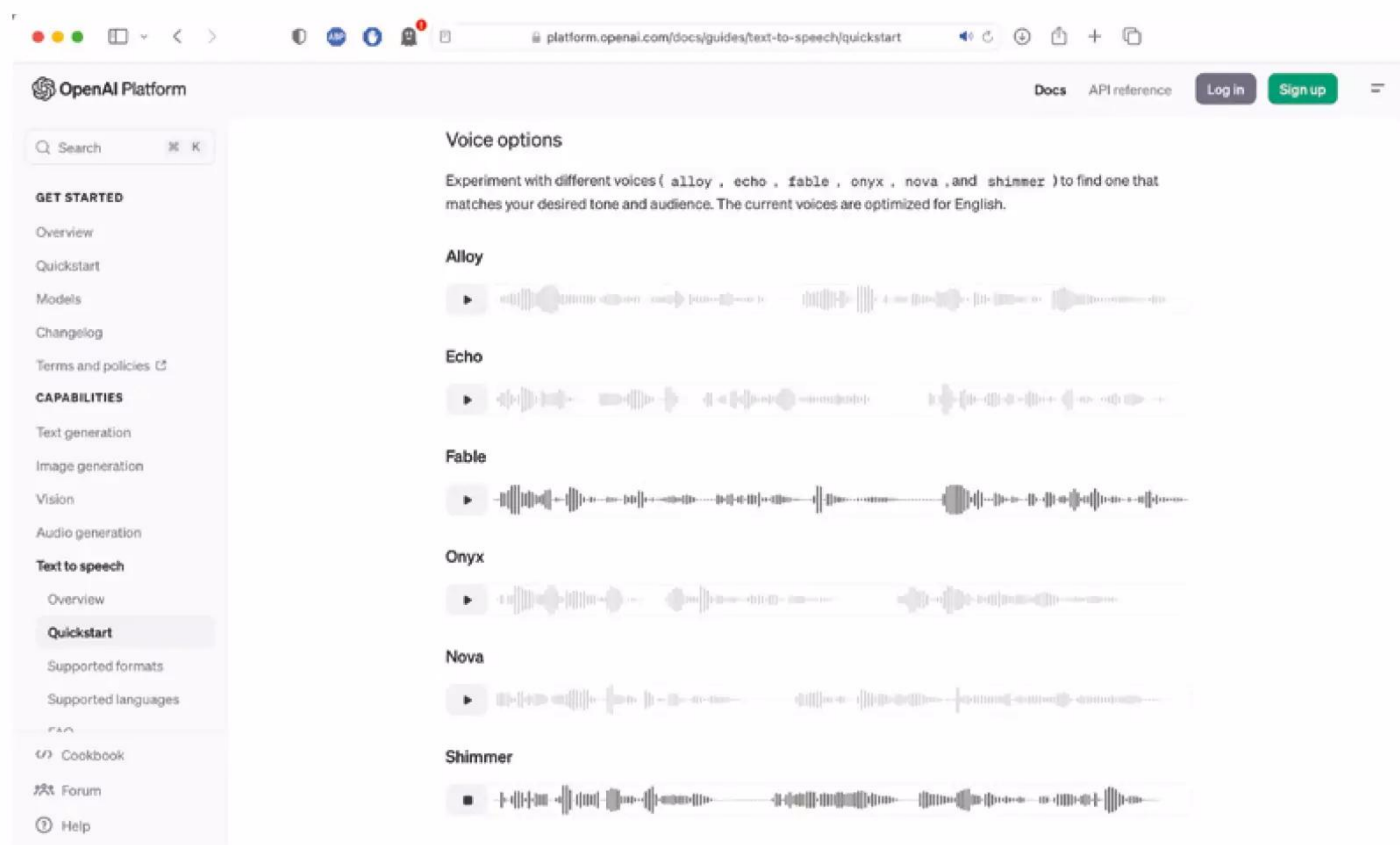

▶ OpenAI text to speech synthesis offers a choice of narrator voices

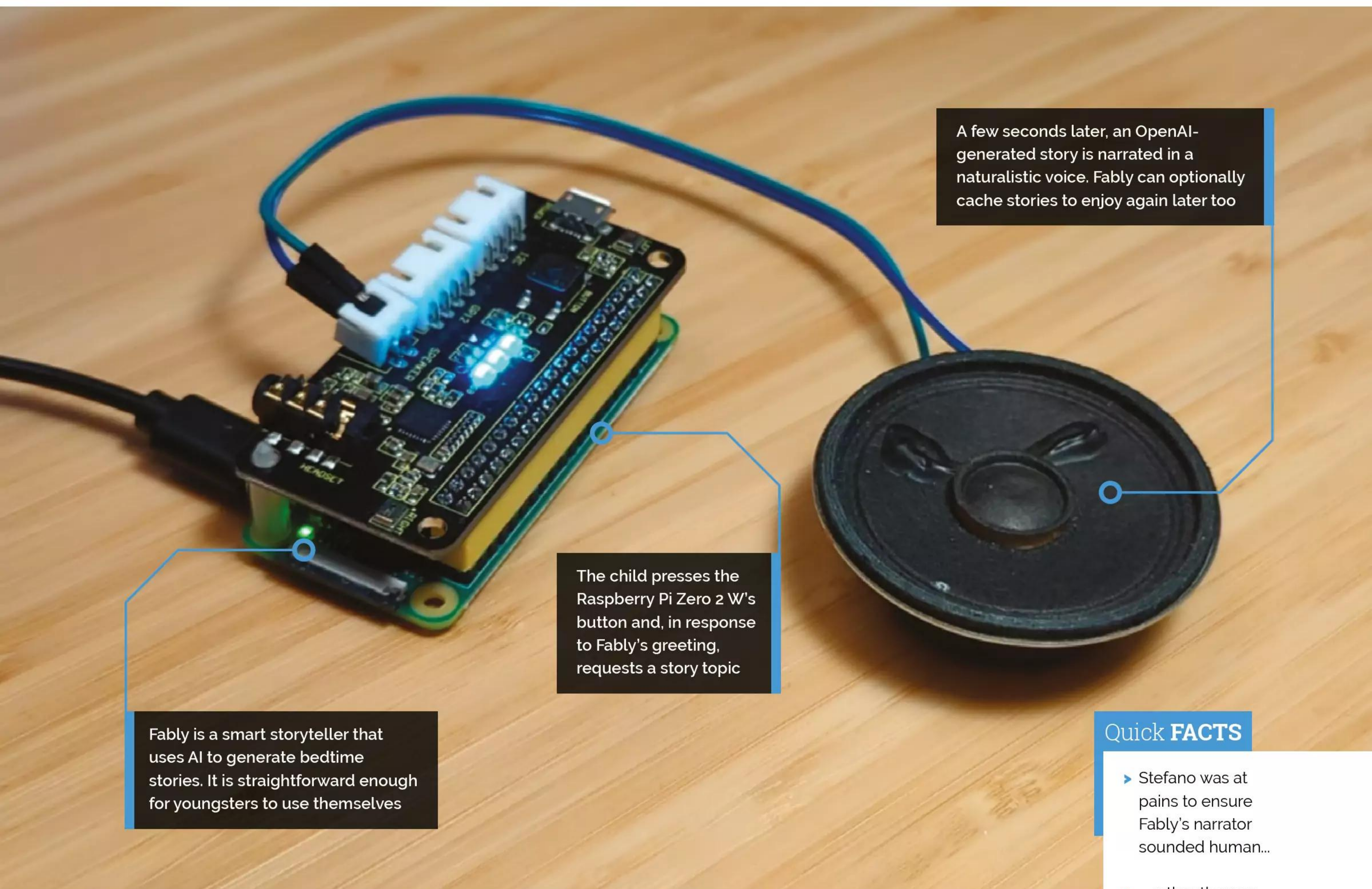

A few seconds later, an OpenAI-generated story is narrated in a naturalistic voice. Fably can optionally cache stories to enjoy again later too

The child presses the Raspberry Pi Zero 2 W's button and, in response to Fably's greeting, requests a story topic

Fably is a smart storyteller that uses AI to generate bedtime stories. It is straightforward enough for youngsters to use themselves

Quick **FACTS**

- ▶ Stefano was at pains to ensure Fably's narrator sounded human...
- ▶ ... rather than an off-putting robot-like experience
- ▶ The Python-based project took a month to complete
- ▶ Fably cost around \$150 to build...
- ▶ ... and will run on any Raspberry Pi

“ The LLM “felt like talking to a person that spoke like a college professor but had the understanding of the world of a five-year-old” ”

led to him pursuing a degree in electronic engineering. Over the past 20 years he has worked with many tech startups and software companies, often with Apache Frontier Foundation, where he became a fellow and met many passionate inventors. Fably, however, was very much inspired by Stefano's own family, particularly his nine-year-old daughter who kept asking him to invent new stories.

Stefano had encountered LLMs (large language models) while working at Google Research and

wondered whether he could use one to create a storytelling machine. Stefano found the command of language impressive but the LLM “felt like talking to a person that spoke like a college professor but had the understanding of the world of a five-year-old. It was a jarring experience especially when they confidently made stuff up.” The phenomenon is often referred to as ‘hallucination’ but Stefano says some colleagues at Google call it ‘fabulism’. He prefers this term and it is the origin of his Raspberry Pi project's

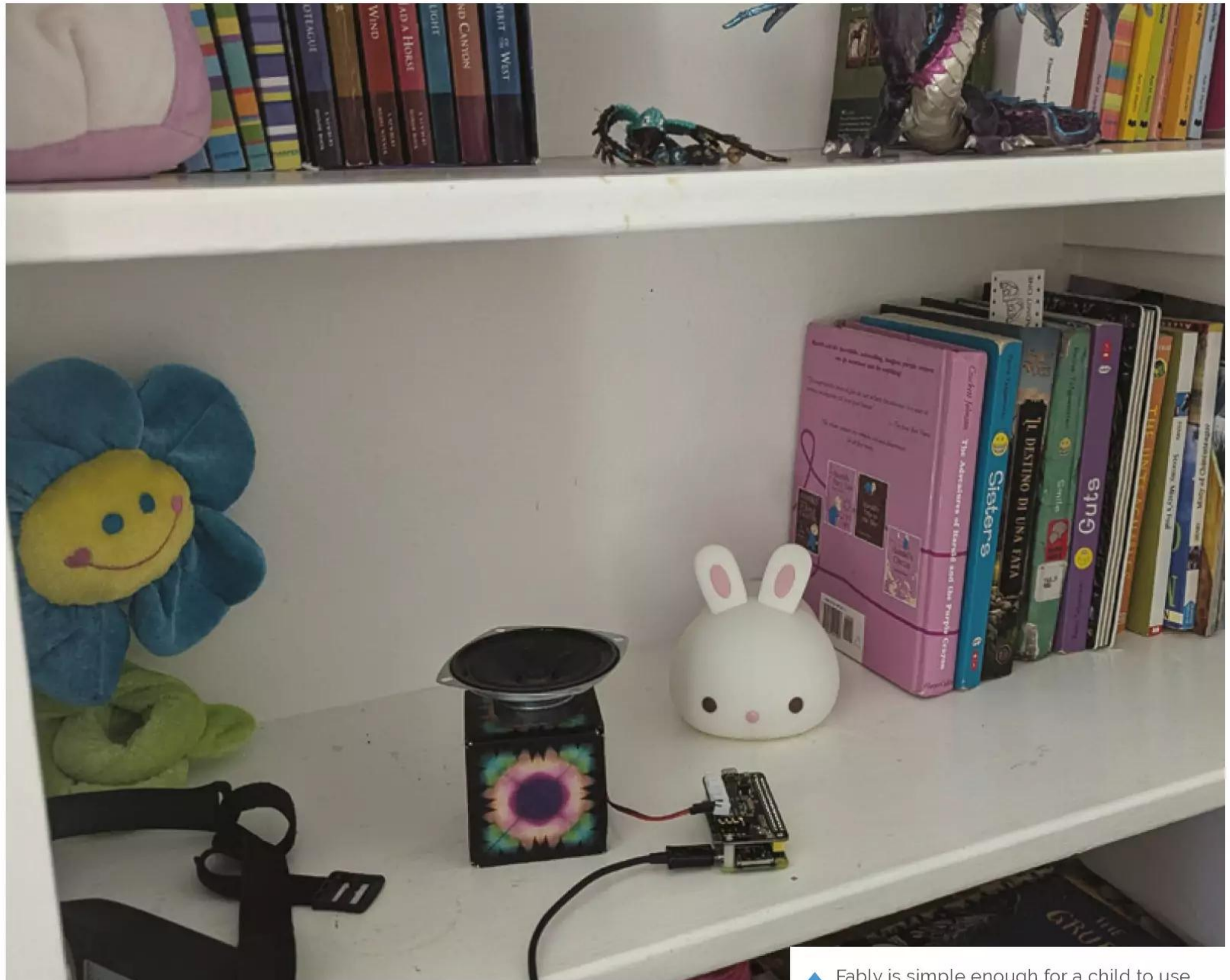

▼ Stefano's YouTube demo has Fably create and tell an AI story in moments

▲ Fably is simple enough for a child to use

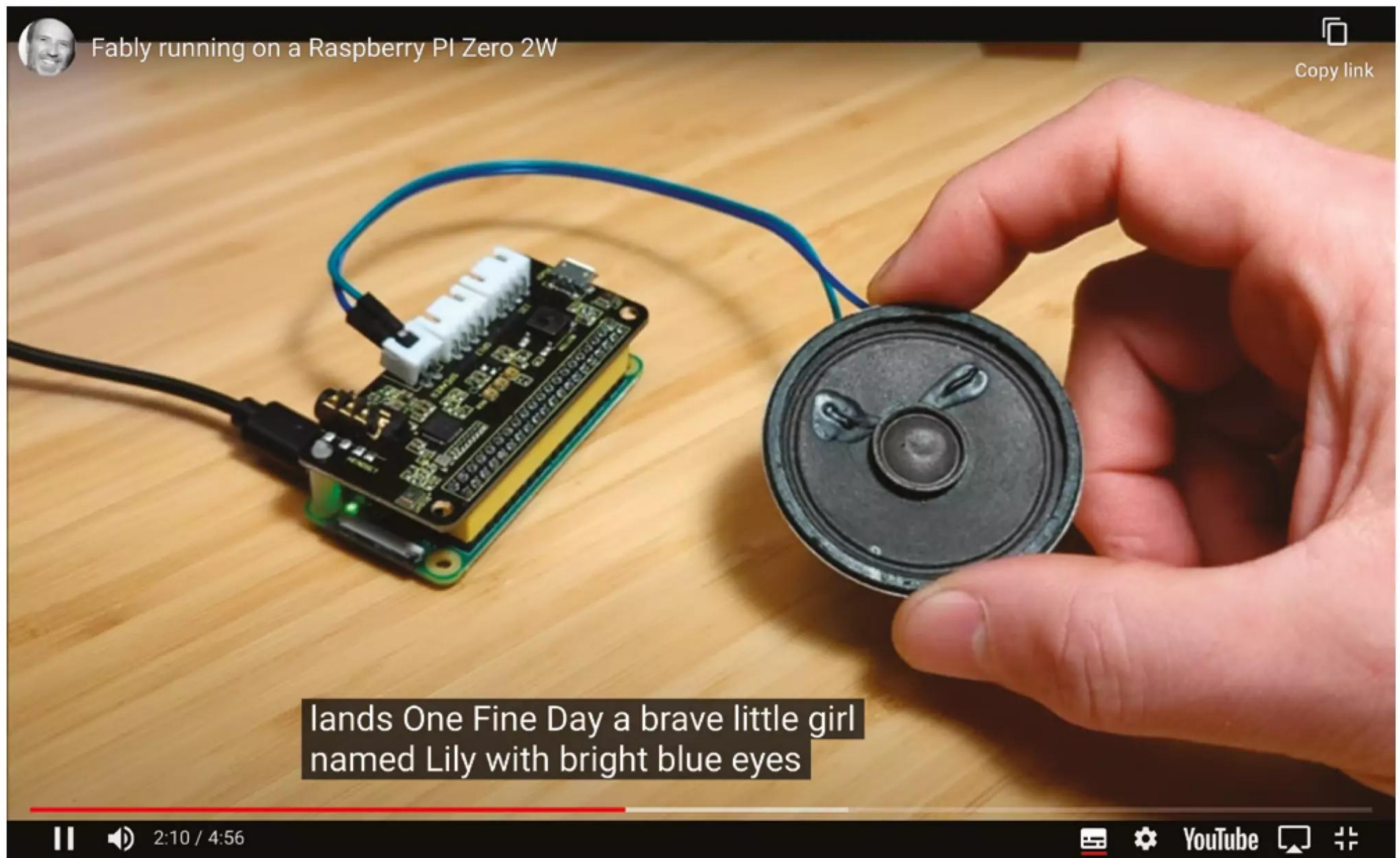

lands One Fine Day a brave little girl named Lily with bright blue eyes

name. Importantly, ‘fably’ is also a word the text to speech synthesis API can pronounce.

As well as making more sense than an overconfident LLM, the smart storyteller needed to come up with compelling stories that engaged the listener and be sufficiently autonomous that it could be used without continuous adult supervision. Being an ambitious, entrepreneurial type, Stefano also wondered about the commercial possibilities and whether Fably could be made at a sufficiently low cost to build a community around it. He notes that children are demanding users

“ The smart storyteller needed to come up with compelling stories and be used without continuous adult supervision ”

being both “impatient and used to interactivity as a foundational aspect of learning”. It would be critical that the “time to first speech” (the time from the last word the child said and the first word coming out of the machine) could not be more than a few seconds.

Every cloud

Since LLMs are very resource-intensive (as he knew from working on machine learning at Google), Stefano chose a cloud API-based approach to address the need for speed, and Raspberry Pi to keep costs down so other technically minded makers could create their own. Raspberry Pi felt like the best choice because of its price, availability, fantastic and very active community, and because it runs Linux directly – a development environment Stefano felt right at home in. Additional hardware such as a microphone could also be added easily. Stefano praised Raspberry Pi’s “relatively stable” I/O pinout across versions in ensuring “a healthy and diverse ecosystem of extension boards”, which could prove important should Fably become a commercial product.

Fably makes full use of OpenAI cloud APIs, alongside a text-to-speech synthesiser with a warm and cosy voice. Stefano’s daughter enjoys the fact that she hears a slightly different story even if she makes the same request. Using a cloud setup means each story costs a few cents, but Fably can be set up to cache stories as well as to cap cloud costs. **M**

Tell tremendous tales

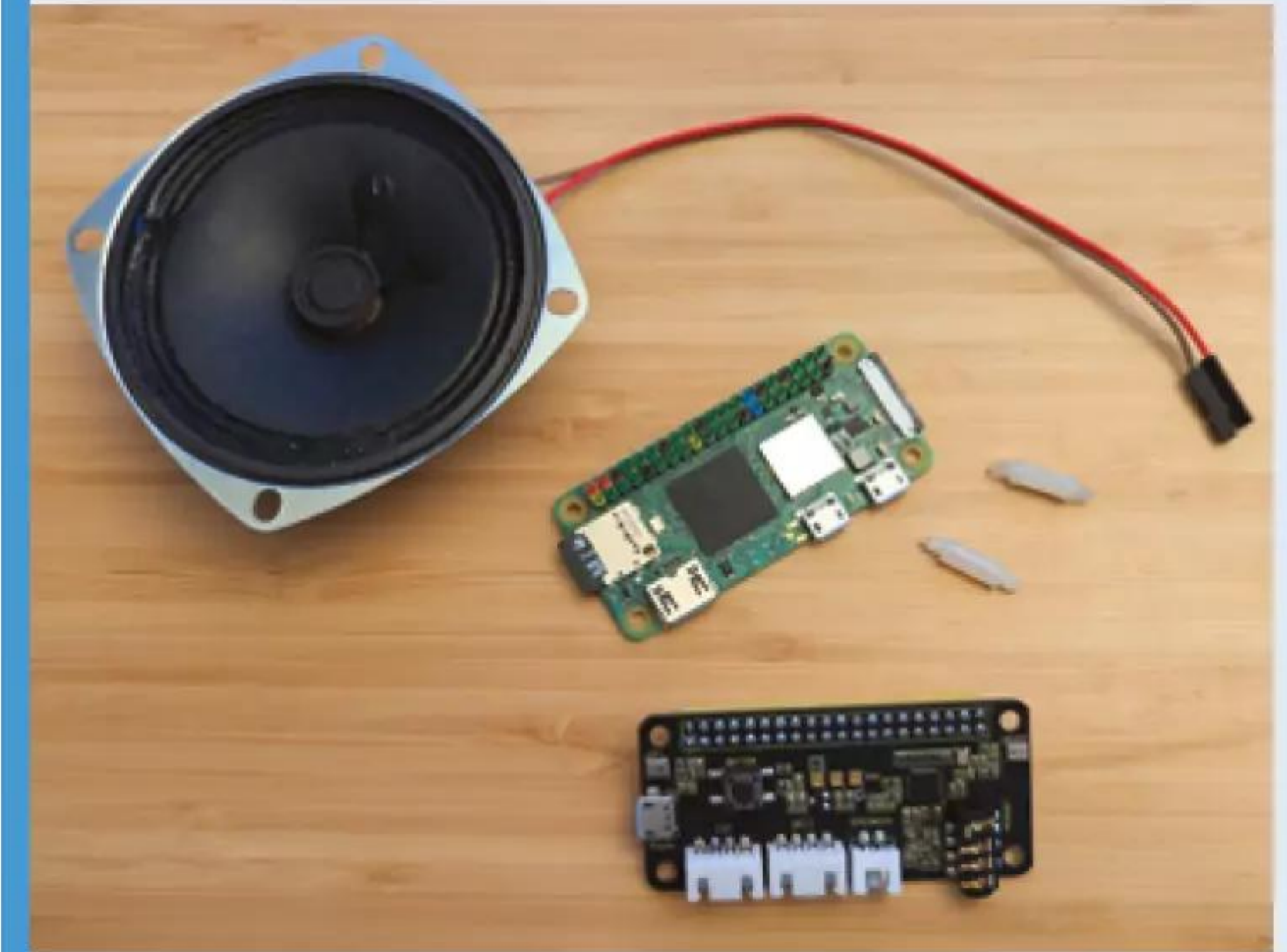

01 Fably can run on any Raspberry Pi from Zero 2 upwards, as well as PC, Mac or Linux. It needs a sound input and a speaker. Full instructions, sample stories and code are at magpi.cc/fablygit.

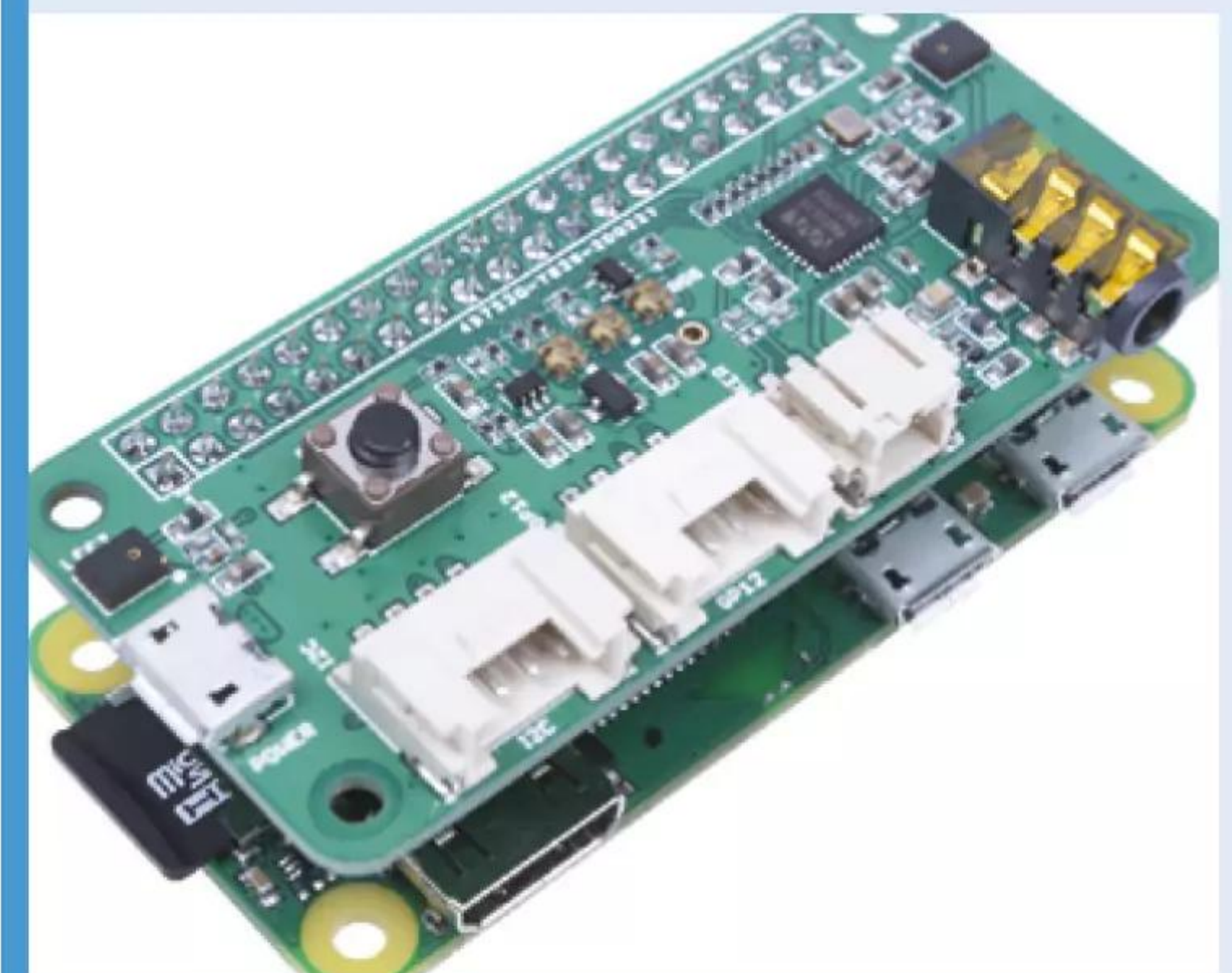

02 You will need an OpenAI key (platform.openai.com) if you want to get Fably to create original stories, a microphone, and a speaker or audio HAT for Raspberry Pi.



03 Follow Stefano’s GitHub instructions to SSH into Raspberry Pi remotely and set up Fably to run when you power it on, and call on APIs in the cloud or locally hosted to generate your stories.

CatBot

Feed the cats without poisoning the birds, thanks to an open-source AI stack. By **Andrew Gregory**



MAKER

Michael Suguitan

An engineer and researcher interested in human-robot and -computer interaction, machine learning, and creative programming.

michaelsuguitan.com/catbot

▼ Because the Raspberry Pi Zero is too underpowered to deploy a computer vision model, a separate Raspberry Pi 5 requests images from the Zero and performs object detection with a small Faster R-CNN MobileNet model

If you like cats, and you want to be alerted whenever a cat wanders into your garden, then we have the project for you. CatBot is a notification system for stray cat sightings. It's a brilliant example of a project that takes a minimal amount of hardware, adds open-source services, and just works.

CatBot is built using two Raspberry Pi boards: the first, a Raspberry Pi Zero, hosts a Raspberry Pi Camera Module 2 and a Flask server, which sends images to a Raspberry Pi 5 for processing. The Raspberry Pi 5 is a much more powerful machine, and so that's where the clever stuff happens: it runs a computer vision model, which determines whether the cat-shaped collection of pixels is a cat. If it's a cat, the Raspberry Pi 5 can send photos to Michael's phone via a Twilio client (as an MMS message, sent to Michael's phone number, not an email).

"I used Raspberry Pi because I was recently working with Raspberry Pi and cameras for another project, a digital sensor for a film camera," says Michael. "Although there are definitely simpler solutions with cheaper microcontrollers, I find it valuable to start with techniques I know rather than going down rabbit holes of learning new tools. I used two separate boards because Raspberry Pi 5 is my home server and NAS, which I did not want to mount on the kitchen window."

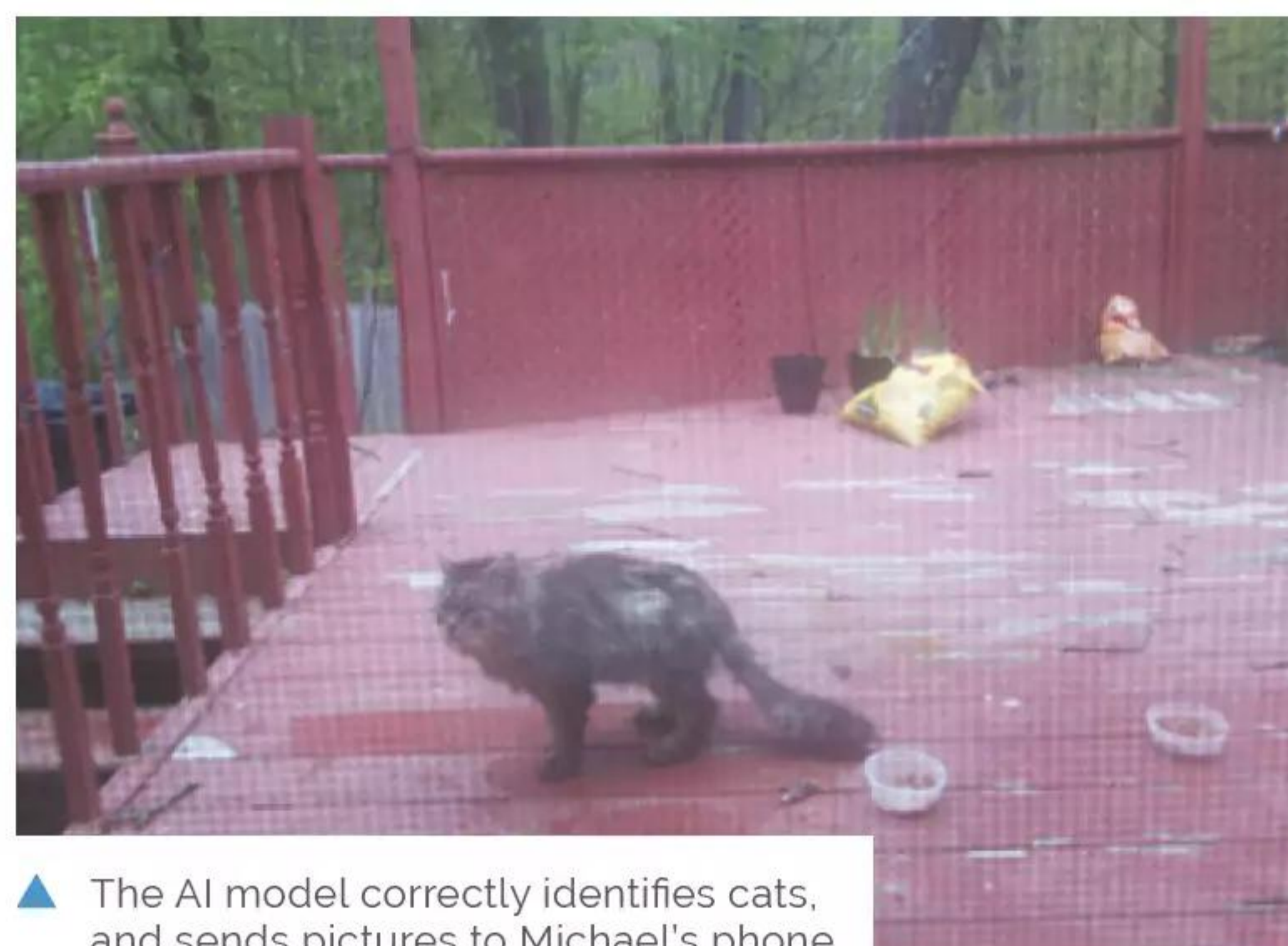

▲ The AI model correctly identifies cats, and sends pictures to Michael's phone

But there's a catch: the food that Michael was leaving out for the cats was also attracting birds, for which cat food is potentially unhealthy, so he needed to find a way of identifying birds and scaring them away. He eventually settled on a minimal solution that just – only just – qualifies for the label of 'robot': an actuator (a Tower Pro micro servo) connected to a chopstick that taps on the window to scare the birds away. If Raspberry

“ I find it valuable to start with techniques I know rather than going down rabbit holes of learning new tools ”

Pi 5 detects a bird, it sends a request to Raspberry Pi Zero to activate the servo.

"Defining 'robot' is hard to pin down and frequently leads to disagreement among roboticists," says Michael. "I believe that a robot is any physical thing with sensors and actuators. While some definitions require autonomy, that excludes arguably robotic things like human-piloted mecha or heavy industrial equipment. Relaxing the requirement of autonomy frames



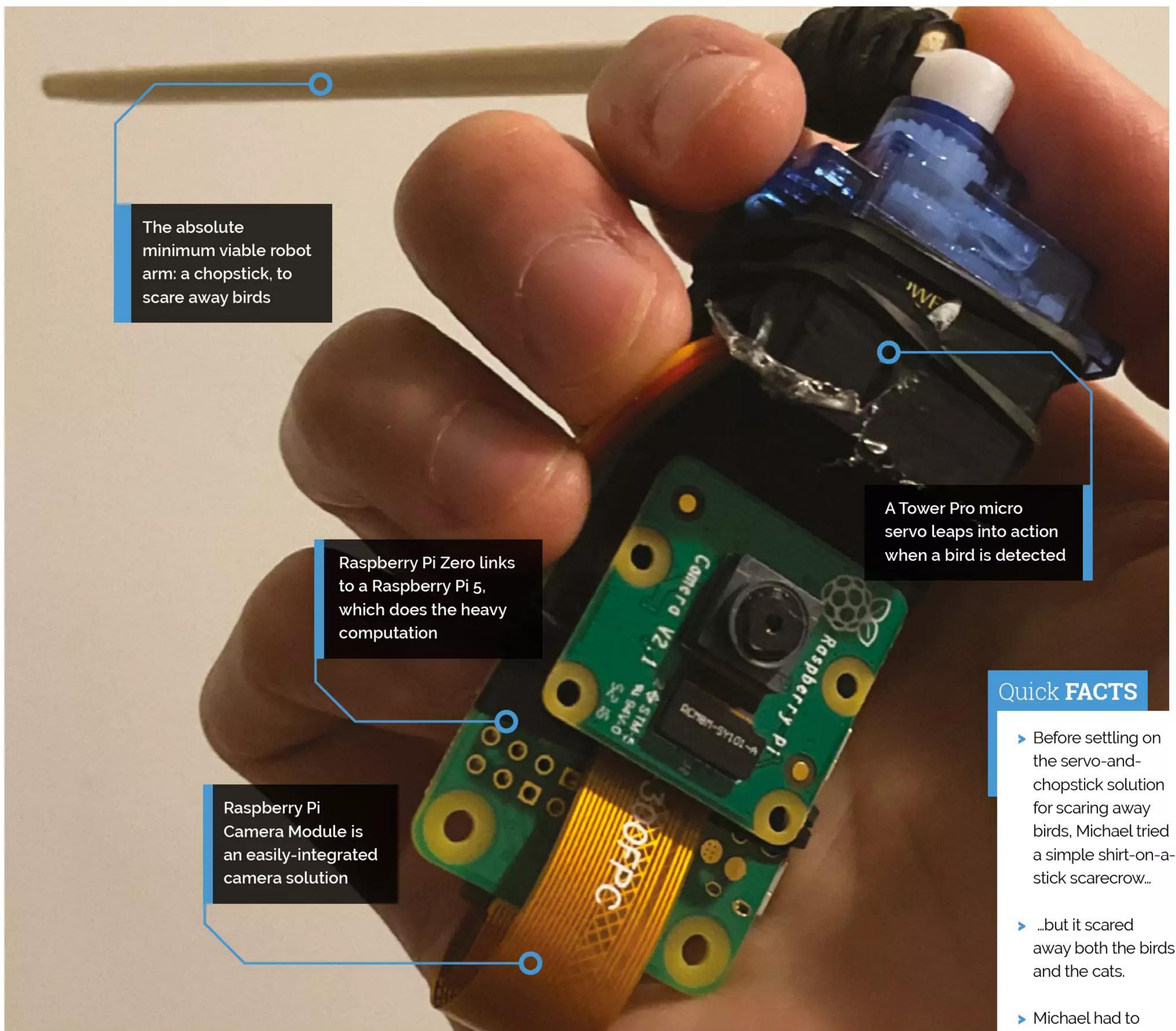

The absolute minimum viable robot arm: a chopstick, to scare away birds

Raspberry Pi Zero links to a Raspberry Pi 5, which does the heavy computation

Raspberry Pi Camera Module is an easily-integrated camera solution

A Tower Pro micro servo leaps into action when a bird is detected

Quick FACTS

- ▶ Before settling on the servo-and-chopstick solution for scaring away birds, Michael tried a simple shirt-on-a-stick scarecrow...
- ▶ ...but it scared away both the birds and the cats.
- ▶ Michael had to reduce the false positive rate by raising the detection threshold for the bird class.
- ▶ You can buy similar devices off the shelf, but they're not as cool as this is.
- ▶ Cats, birds and raccoons all like free food.

◀ The work of building this project was mostly integrating the various subsystems

robots as tools that complement rather than supplant our abilities, which I find valuable in the current hype wave of AI and ML.

“There are commercial products that do similar things, like the Bird Buddy or pet-oriented indoor security cameras. By the time that I could hack those to get the functionality I wanted, I might as well have started with open-source tools.”

“My favorite projects include Blossom, an open-source robot platform that I developed during my PhD, and the Leica MPi, a swappable digital sensor for a Leica film camera. I’m currently taking a sabbatical at the Recurse Center, a programming retreat in New York, where I am exploring alternative HCI hardware and brushing up on AIML for robotics.” **M**

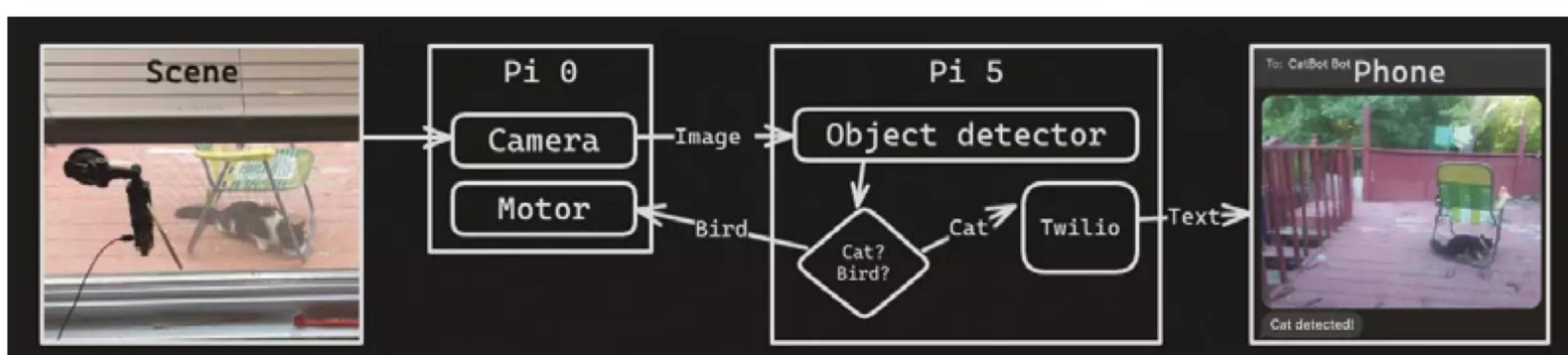

Bumpin' Sticker

When Guy Dupont spotted a bumper sticker expressing love for experimental jazz, he decided to 'sax' it up by creating a changeable digital version, as **David Crookes** discovers



MAKER

Guy Dupont

Guy is a software developer, audio engineer, and hardware hacker from Cambridge, MA. He likes to build things that make people say: "That's ridiculous, but I would buy one anyways!"

magpi.cc/bumpinstick

Bumper stickers have been around since 1946 when an American silkscreen printer called Forest P Gill spotted the popularity of attaching advertising messages to the rear of vehicles and combined adhesive-backed paper with fluorescent paint – significantly upgrading the old practice of printing messages on a piece of cardboard or metal and attaching them with wire.

They weren't great – they'd often become soggy in wet weather – but they became widely used, particularly in the US. Still popular today, they enable drivers to promote goods and services, express humour, highlight political and religious affiliations, and share their love of sports teams. But what if someone wanted to change their message depending on their mood or the time of year? Is it really practical to keep peeling and replacing?

During a long morning walk, Guy Dupont began thinking along those lines. He'd spotted a car in his neighbourhood with a sticker that read, "Keep Honking! I'm listening to Alice Coltrane's meteoric sensation 'Universal Consciousness'!" (a sticker which appeared on countless vehicles) and he believed the concept could be vastly improved.

"I love the idea of using bumper stickers as a form of self-expression, but I got to thinking about how 'permanent' they are, and how my own style, mood and taste tends to change relatively quickly," he says. "I wanted to see how I could resolve those things – could I make a bumper sticker that was always up to date? Would it still be interesting if it wasn't permanent?"

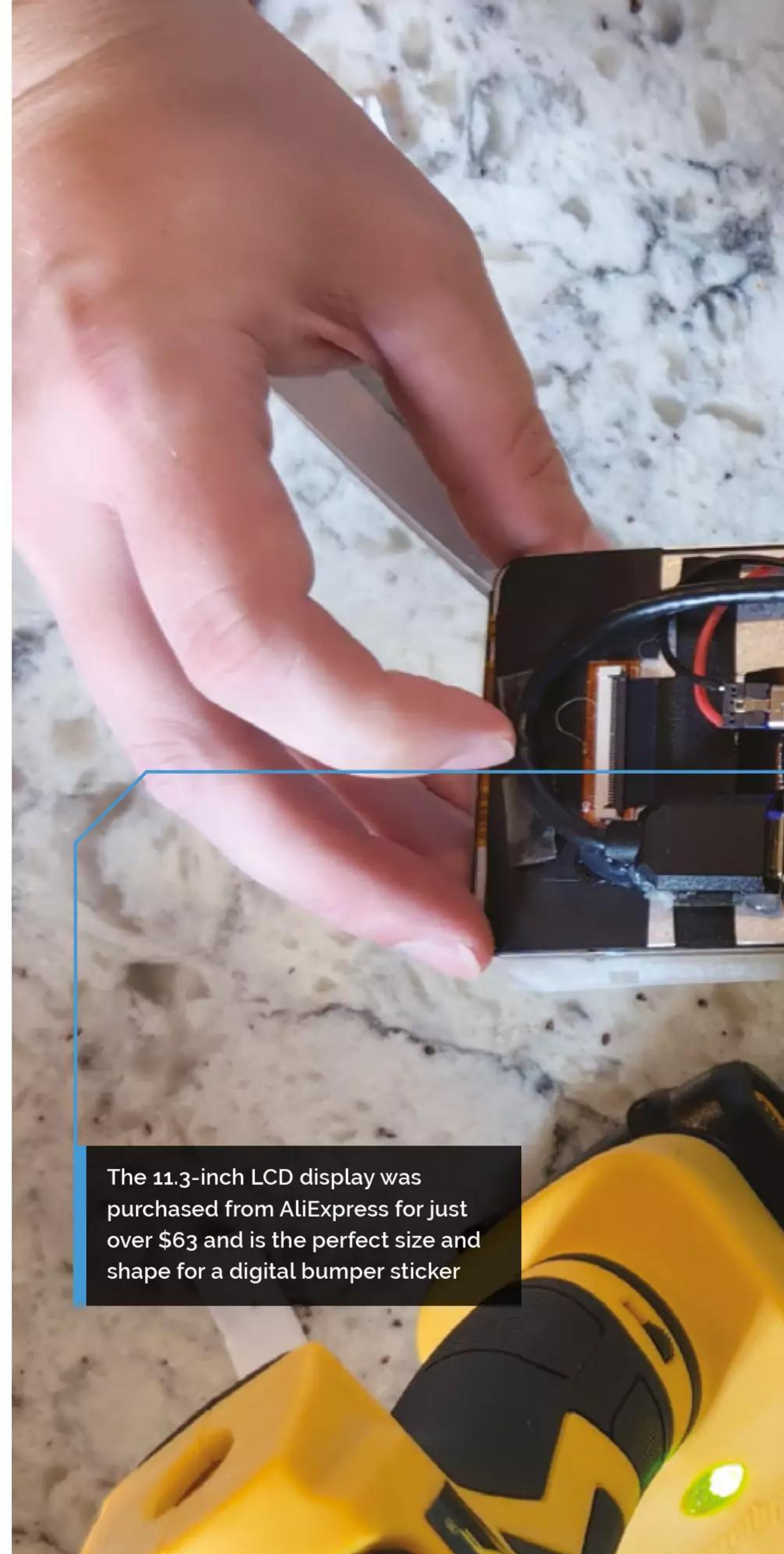

The 11.3-inch LCD display was purchased from AliExpress for just over \$63 and is the perfect size and shape for a digital bumper sticker

On track

Figuring a changeable bumper sticker would be both practical and fun, he initially decided to experiment by connecting a Raspberry Pi Zero 2 W computer to a 5-volt HDMI display before working out a way to gather and share information about the song he was currently listening to in near real-time. He figured the best method would be to connect the Raspberry Pi device to the internet and make use of the online music service Last.fm. "It's a 'scrobbling' tool that you can use to keep track of everything you listen to, regardless of where you're listening from," Guy explains.

By connecting Spotify to his Last.fm account, Guy had a way of grabbing details about his most recently played tune. Raspberry Pi could then pull that information and send it to the display for others to view. Since he wanted his project to look like a bumper sticker, this entailed creating an easily updated graphic – one with black text on a

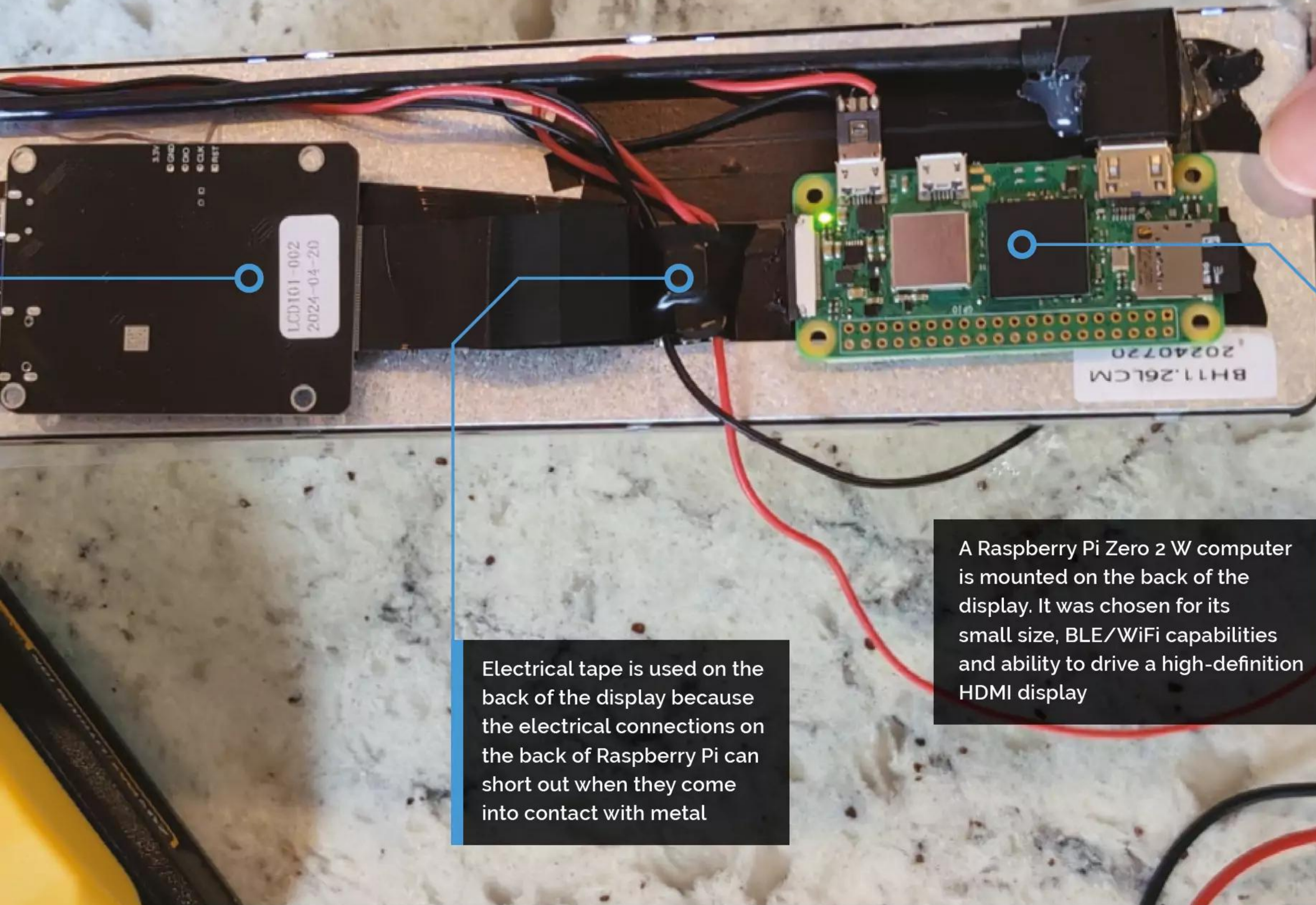

Electrical tape is used on the back of the display because the electrical connections on the back of Raspberry Pi can short out when they come into contact with metal

A Raspberry Pi Zero 2 W computer is mounted on the back of the display. It was chosen for its small size, BLE/WiFi capabilities and ability to drive a high-definition HDMI display

Quick FACTS

- ▶ It's a realistic-looking digital bumper sticker
- ▶ It'll display the last song you listened to
- ▶ Data is automatically scraped from last.fm
- ▶ A PNG image is created using Val Town
- ▶ Power is obtained from the car battery
- ◀ From a distance, you wouldn't be able to tell that the bumper sticker is a digital display





▲ The project is open source with the code available at magpi.cc/bumpinstickgh

yellow background – that could be easily updated with new details – and Guy came up with the idea of using an image file that could be produced and rendered just before it was shown.

To enable this, Guy turned to a social website called Val Town which allows developers to code in the cloud. He wrote a small chunk of code – referred to as a val – that would access and fetch his Last.fm profile to gather details of the last song he was listening to. He then, with the assistance of Val Town’s AI, wrote another val to use a Javascript HTML5 canvas library to lay out the bumper sticker using the information gathered. This involved a lot of trial and error to make the text fit correctly, but he was able to successfully create, export and display a PNG image without any manual intervention.

Driving forward

With the nuts and bolts of the project in place, it was time to start refining. “I always start with components I already have or already know how to use,” Guy says. “I then quickly get as close as I can to a finished version, and then I see if there are any deal-breakers or cheap and obvious ways

▶ The heat-shrunk, weatherproofed device also comes with a warning to potential thieves on the back, telling them they won’t be able to get it to work if they steal it.

to improve the design. I find that momentum, as well as the ability to see and feel a project early on, really helps me stay on track, even if I know I’m going to have to revise things.

Given the idea was to create a device that looked as much like a real bumper sticker as possible, Dupont swapped out the display for an 11.3-inch strip LCD. “Size, shape, and readability came before anything else,” he explained. Figuring he’d be drawing power from a 12-volt car battery, he also grabbed a couple of breakout connectors and a buck converter to knock the power down to five volts.

Initial plans to connect the Raspberry Pi computer to the internet using a hotspot on his

“ I always start with components I already have or already know how to use ”

phone were revised as well. Dupont realised that he’d need to manually connect Raspberry Pi to the hotspot every time he got into his car and he knew, in his heart of hearts, that he would eventually tire of doing this, causing him to eventually consign the project to a drawer. To avoid this situation, he utilised a Particle Baron IoT development board which he also happened to have lying around.

“The main advantage of the board versus using the phone as a hotspot is that I never have to





touch it or remember to turn it on,” he says. The board connects to Raspberry Pi and uses cellular data, the bonus being there are no monthly fees. The data is limited in quantity, but there’s more than enough for Guy’s intended use which makes for a perfect fit. With everything working, it was then a case of installing it, which required a spot of in-car wiring – and some dismantling of the vehicle’s interior panels.

The right path

The Raspberry Pi and other components were affixed to the back of the display panel which was also fitted with magnets to allow the device to be easily secured to the back of the car. For a neat finish, the device was placed in a heat-shrink sleeve that happened to be the perfect size. A bit of cutting was then required to allow the screen to show through, and Guy used some glue around the cuts for weatherproofing.

It works well. Powered by the car battery as soon as the vehicle is turned on, it immediately connects to the internet, grabs the required information and displays it. “Honestly, everything went pretty smoothly with this build,” Guy said. “It’s funny, but the thing that held me up the most was trying to figure out which HDMI settings would make this oddball display show what I wanted it to!”

Guy particularly likes the fact that it’s entirely automated so he always knows that it’ll be displaying his songs when he tootling down the road. “It lives with the car, which also means the sticker continues to work even if my wife is driving,” he laughs. “I’m afraid to ask whether she thinks that’s a bug or feature!” 

▲ The bumper sticker is wired to the car’s battery and, for a neat finish, you would need to gain access to various parts of the vehicle’s innards

Road to success

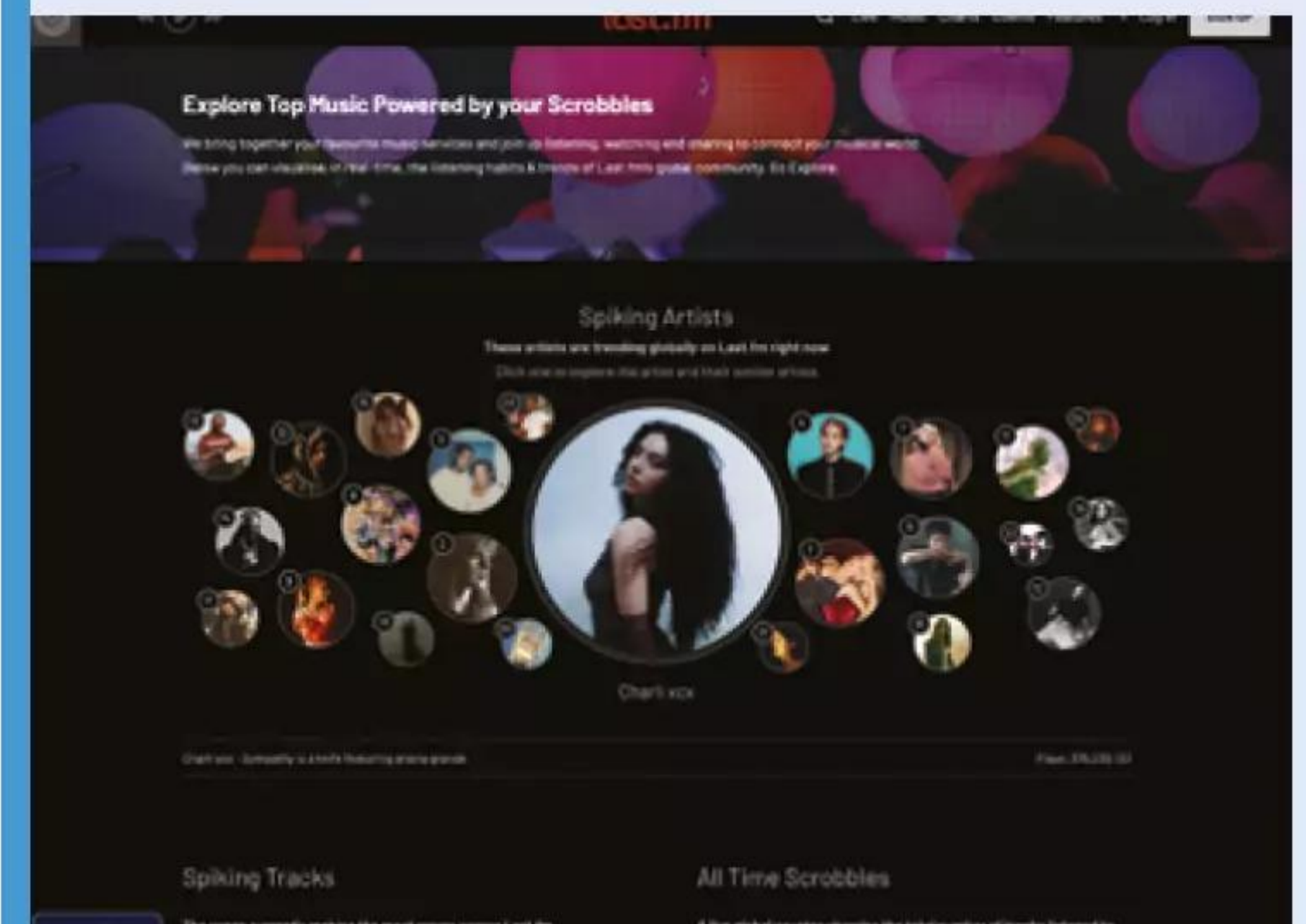

01 A function written in Typescript and deployed on **val.town** periodically fetches Guy’s profile from **last.fm** and scrapes his most recently played item from the web page. When the car is turned on, Raspberry Pi receives power from the battery and connects to the internet.

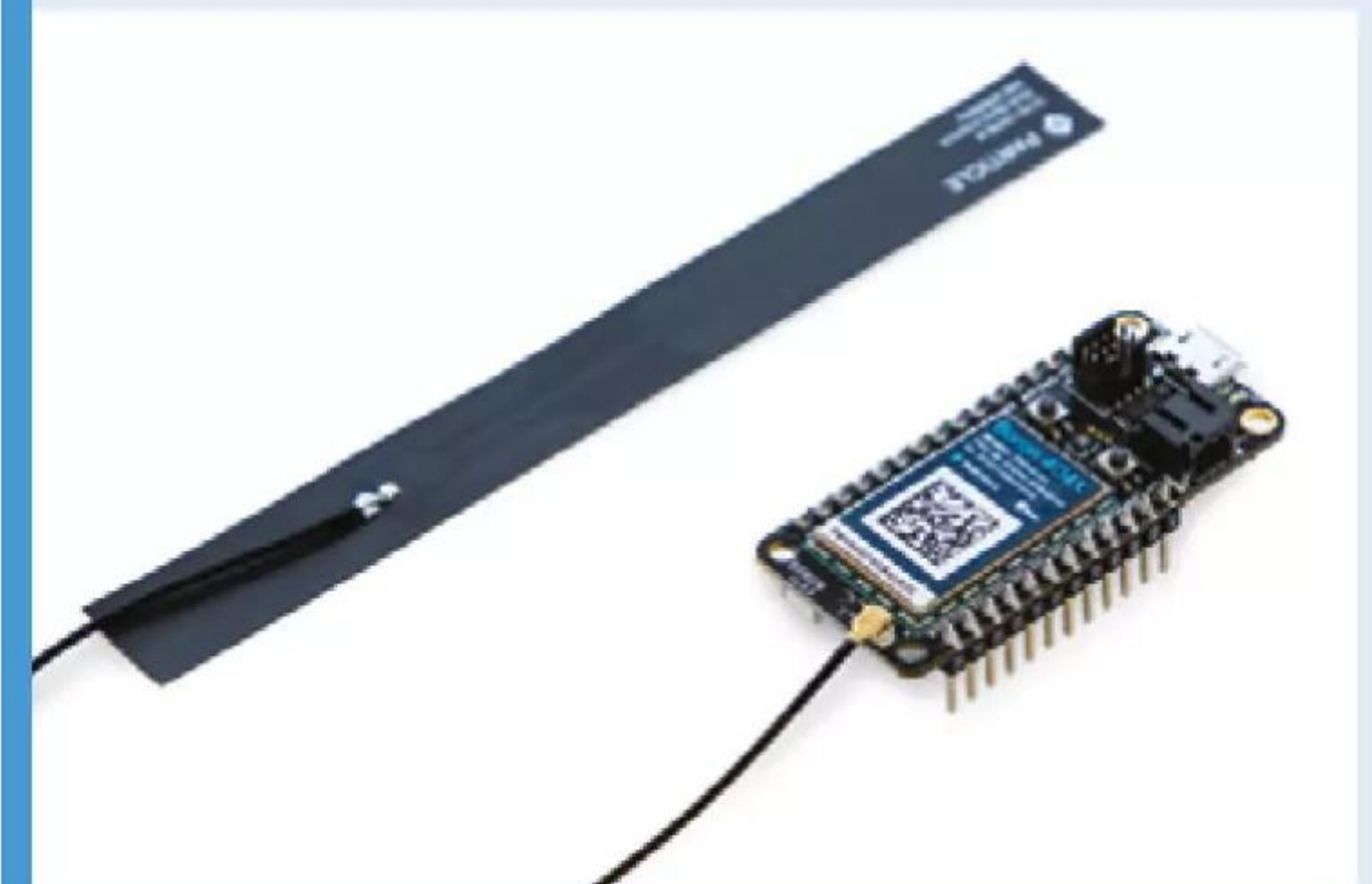

02 From inside the car, the Particle Boron IoT board uses its cellular connection to fetch the scraped data from **val.town** via Particle’s webhook system. It then rebroadcasts that data as a JSON string using a Bluetooth Low Energy GATT Characteristic.



03 The Raspberry Pi has a loop that reads the latest data from the Boron’s BLE Characteristic. It generates a bumper sticker image and displays it via HDMI. The image generation script was also written in Typescript and can be run either locally on Raspberry Pi or in the cloud, on **val.town**.

T-Rex Game Auto Jumper

Is it really cheating at a game if you take the time to program a robot that plays it? **Rob Zwetsloot** sits back and finds out



Bas op ten Berg

A trainer, maker, university lecturer, and consultant in electro-mechanical prototyping, located in the Netherlands. He's the owner of BotBerg

magpi.cc/autotrex

For those who have used Google Chrome (which is apparently most people: gs.statcounter.com), you may have seen the screen that pops up when your internet connection fails. It's of a pixelated T-Rex, and if you press the space bar, you can kill time before your internet connection is restored by playing a little cactus-jumping game. If your internet goes down for a really long time, then maybe you can automate playing it.

Maker Bas op ten Berg presented us his project, the full name of which is 'Automatic Jumping in the T-Rex Game: Detecting Cacti with a Raspberry Pi Pico CircuitPython HID Controller', that does just that.

"Using a Raspberry Pi Pico, a light dependent resistor (LDR), a breadboard, some DuPont cables, and tape, I automated the famous Google T-Rex game," Bas explains. "The LDR

detects differences in analogue measurements whenever it senses cacti, which are always dark-coloured and appear on the same plane. The analogue-digital converter [ADC] port of the Pico measures each passing cactus ten times per second. After a 0.2-second delay, the Human Interface Device [HID] library simulates pressing the 'up' button on the keyboard, making the T-Rex jump at the right time."

For Bas it was a fun way to show people he teaches and trains how the HID libraries work in code: "I've found that simulating single or multiple key presses with embedded processors stimulates the creativity and inventiveness of training participants," he tells us.

See the light

Raspberry Pi Pico was the obvious choice for Bas. "[It's] easy to obtain, very cost-effective, and supports MicroPython, CircuitPython, and Arduino C++," Bas says. "It has a small form factor, can be easily soldered onto a prototyping board using castellated connections, or placed into a breadboard using headers. Personally, I like the Pimoroni Pico Explorer Base for prototyping, as it includes a breadboard, LCD screen, buttons, and breakout connectors. I especially appreciate the MicroPython and CircuitPython capabilities – they're easy to explain to students, powerful, [and have a] wide range of libraries."

The build itself is fairly simple – an LDR is placed in front of the screen, with tape acting as 'blinders' to stop other light interference. A pull-up resistor was used to stabilise the measurements too.

"The program displayed the measured [light] values in real time, making it easy to define and adjust the threshold values to trigger the T-Rex's jump," Bas further explains. "I stored the delay time for simulating the 'up' button press in a

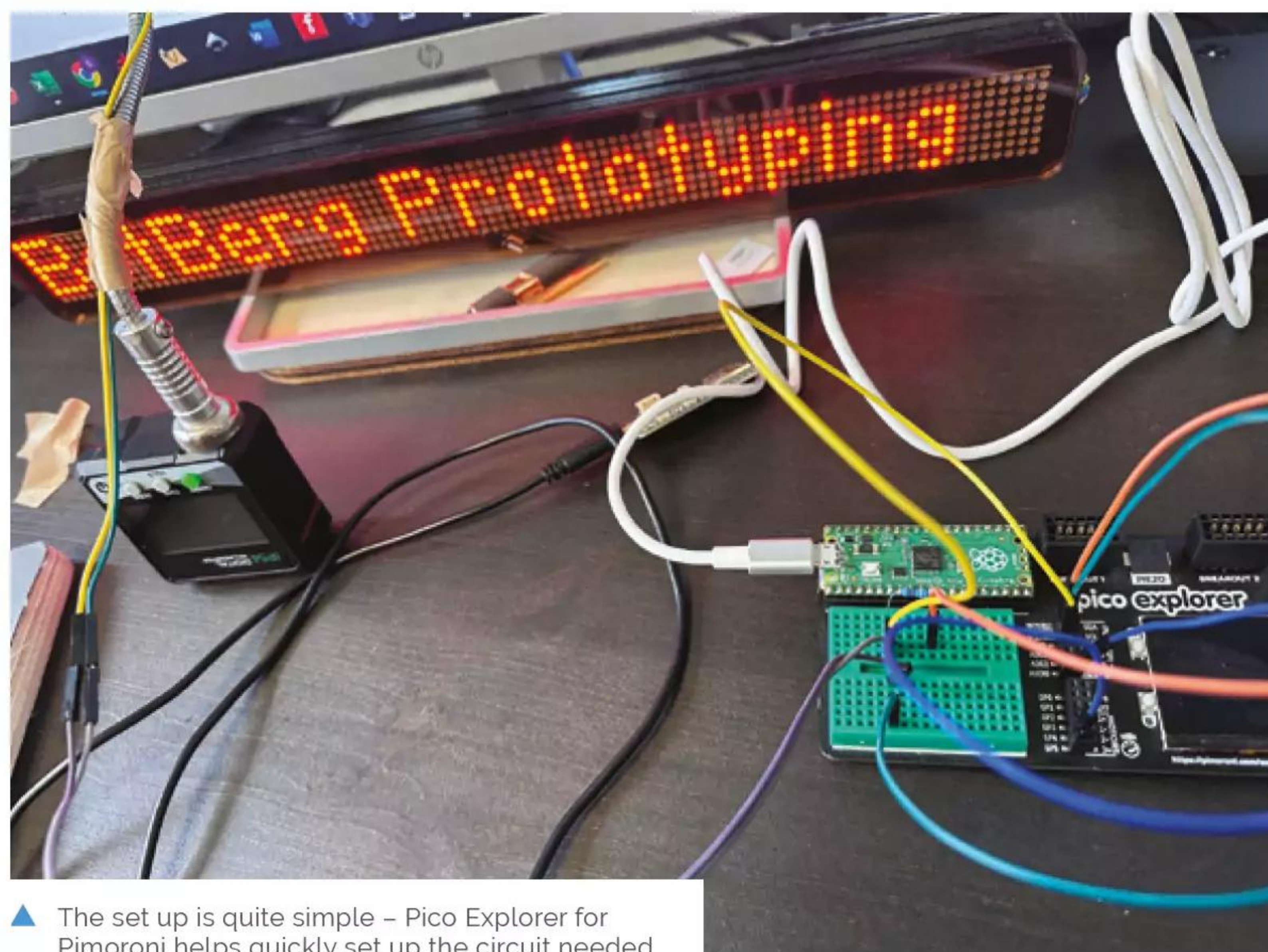

▲ The set up is quite simple – Pico Explorer for Pimoroni helps quickly set up the circuit needed

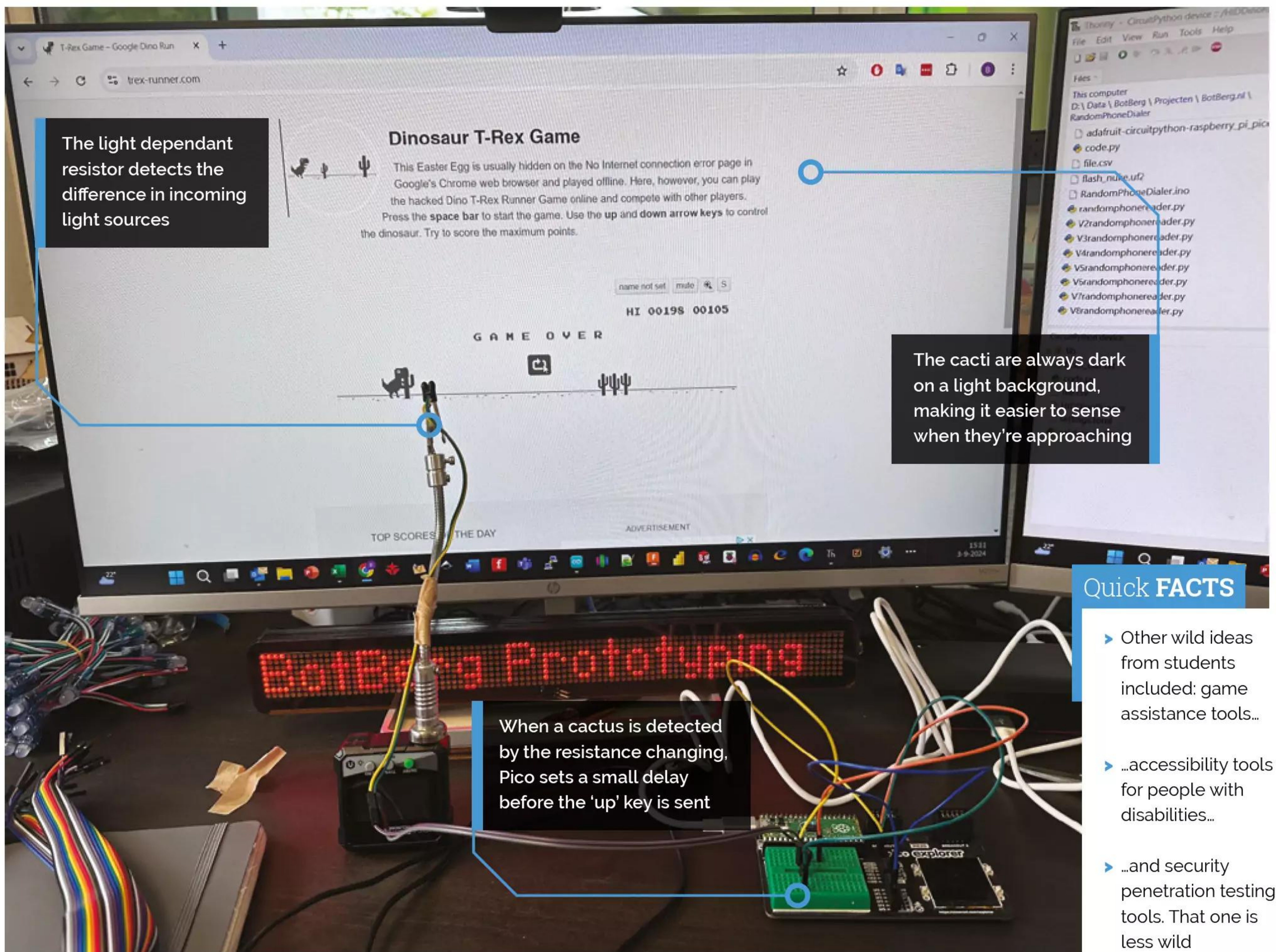

“ The build itself is fairly simple – an LDR is placed in front of the screen, with tape acting as ‘blindings’ to stop other light interference ”

Python variable, allowing for easy adjustments through Thonny.”

Jumping ahead

What’s next for the T-Rex Jumper? “I have various future plans for these types of educational setups,” Bas says. “I’m always excited when participants in my trainings come up with creative ideas for using HID functions in combination with sensors and actuators, as it means I’ve succeeded in educating them about computer science and improving their digital literacy. Personally, I find it very rewarding to develop and create accessibility tools for people

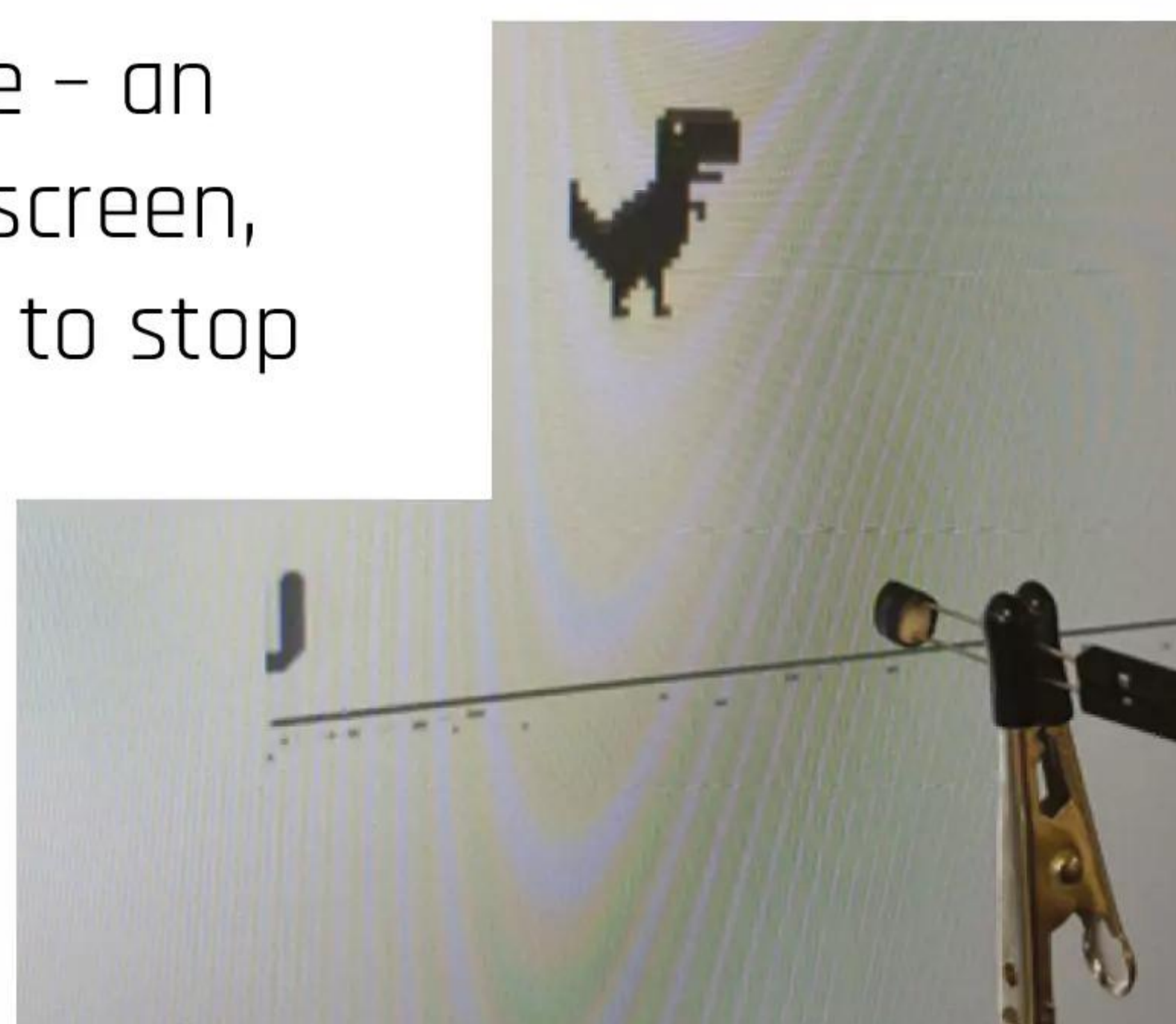

with disabilities, as they can greatly improve quality of life and make a meaningful difference.

Speaking of the creative ideas they came up, here’s just a few: automatic typing poem generators, pedal-based keyboards, automated testing tools for user interfaces, automatic swiping of dating apps... the list goes on. **M**

- ▶ It was inspired by a project that used a servo to press the 'up' key
- ▶ A lot of Bas' other projects are educational for his role as a trainer
- ◀ The LDR is right up against the screen, with a small bit of tape to block out the rest of the world

Wax

Organising and playing your classical music collection is simple with this easy-to-use Python program. **Rob Zwetsloot** has a listen



MAKER

Jeffrey Barish

Jeffrey is a retired music lover and fan of Python, with high standards for audio systems

magpi.cc/waxmusic

There are many ways to organise – and play – your music with Raspberry Pi, and we’ve told you how to use a few in the pages of this very magazine over the last decade or so. Maker Jeffrey Barish has created a way to simplify the process using only a Python script, with classical music in mind.

“[It’s] designed for music lovers, not programming wizards,” Jeffrey explains. “By taking a novel approach to the challenge of cataloguing a music collection, Wax avoids frustrations associated with other music management systems, especially when handling classical music. Other programs force users to

think about tags, file names and layout, style guidelines, compilations, parents, and more. Wax hides the gears and levers, providing operation that is more natural and intuitive. It makes it possible to enjoy your collection as a collection of music rather than a collection of data.”

Wax differs from most existing music managers in three ways. Instead of individual tracks, music is catalogued as ‘works’ – such as an album, a symphony, an opera, etc. Secondly, works are categorised by genre, but it also allows you to tag works in a way that is relevant to the genre too; symphonic works can include

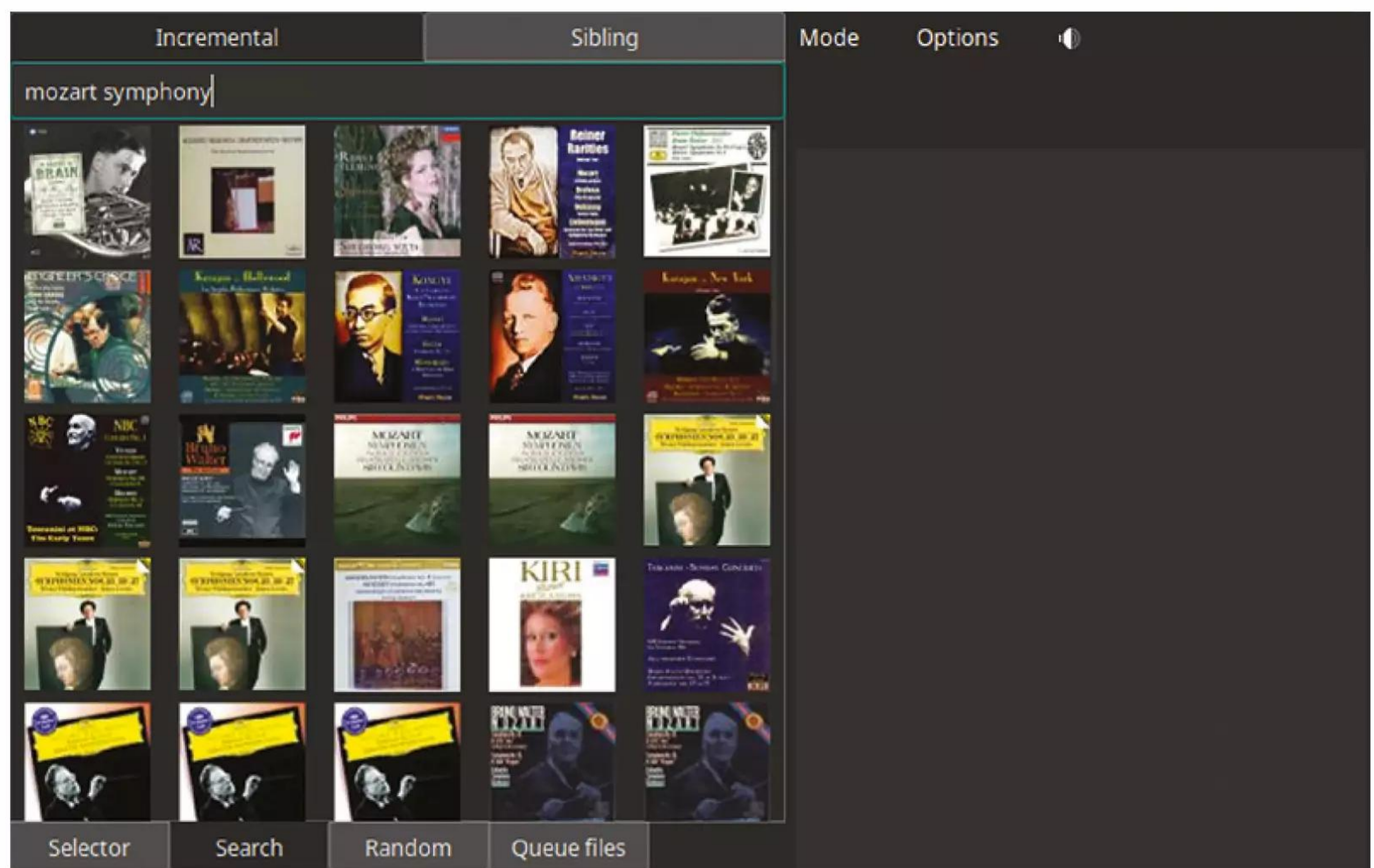

▶ You can search by kind of music you want, or by specific works

Find your favourite Late Romantic symphony, and your preferred conductor of that symphony easily

The screenshot shows the Wax music player interface. On the left, a list of Late Romantic symphonies is displayed, grouped by composer and work. The selected item is Verdi's 'Messa da Requiem' by conductor Pappano. Below the list are buttons for 'Selector', 'Search', 'Random', and 'Queue files'. On the right, a detailed view of the selected item is shown, including the track title, composer, conductor, and a play button. The interface also displays the current item's duration (1:33:05) and the total duration of the playlist (3:59:18).

While music is grouped by works, you can dive deeper and queue up single tracks or groups of tracks – such as requiems in an opera

You can queue up works just like with traditional music players

Quick FACTS

- ▶ Jeffrey has a modest collection of 3600 recordings...
- ▶ ... they're mostly in FLAC so they take up about 750 GB
- ▶ Wax is smart enough to suggest familiar names when editing works
- ▶ Redundant scraped data, such as repeated classical music track titles, can be easily edited
- ▶ You can go through to Wikipedia pages on works you're listening to

composer and conductor, while pop music comes with the group and title.

The final feature is that it will start playing music as soon as you've given it enough requirements (in the form of metadata), which you can then change on the fly.

Multi-core wonder

Wax is specifically designed for Raspberry Pi 4 because of its quad-core processor. "Wax uses one core to run the user interface, one for playing, one for ripping, and the fourth for time-consuming tasks like fetching metadata from the cloud, like MusicBrainz and Cover Art Archive," Jeffrey says. "Many audiophiles worry needlessly that burdening a processor involved

The screenshot shows the Wax music player interface displaying metadata for a piano concerto. The metadata includes the composer (Felix Mendelssohn), work (Piano Concerto No. 1 in G minor, Op. 25), soloist (Ingrid Fliter), conductor (Antonio Méndez), orchestra (Scottish Chamber Orchestra), and date (2016). On the right, a detailed view of the cover art is shown, featuring the soloist and the orchestra. The interface also displays the current item's duration (19:46) and the total duration of the playlist (7:24).

- ▶ As music plays you get the usual data you'd expect but you can also access the Wikipedia page on a work to learn more

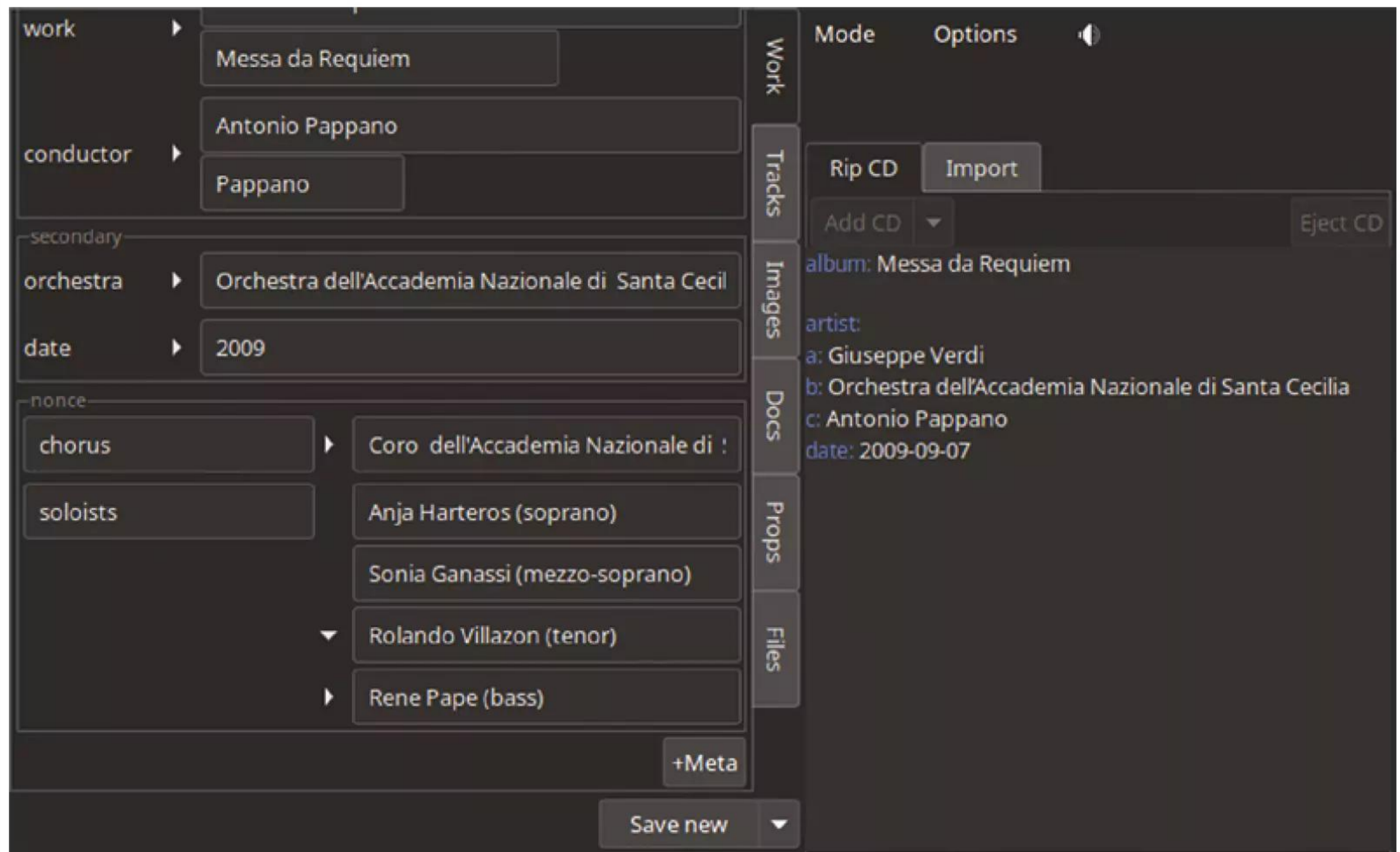

▶ You can use scraped or custom data to create and edit works in your library

in playing a sound file can impair the quality of the sound it produces. The multi-processing architecture of Wax obviates this concern as the core responsible for playing the music is not simultaneously performing any other tasks.”

From the app you can select music starting by genre. “Works by the same composer are listed together,” Jeffrey tells us. “Likewise, multiple versions of each work are listed together. This hierarchical sorting makes it easy to survey the collection for the desired recording – possibly

one that you forgot you had. Wax also provides incremental search if you already have a specific work in mind.”

Individual tracks or even the entire work can be added to the queue. You can also group tracks within a work – perhaps to represent the acts of an opera. “The other interesting feature is that the values in any column can alternatively be represented as a filter button,” Jeffrey continues. “[I can convert] the ‘subgenre’ field to a filter

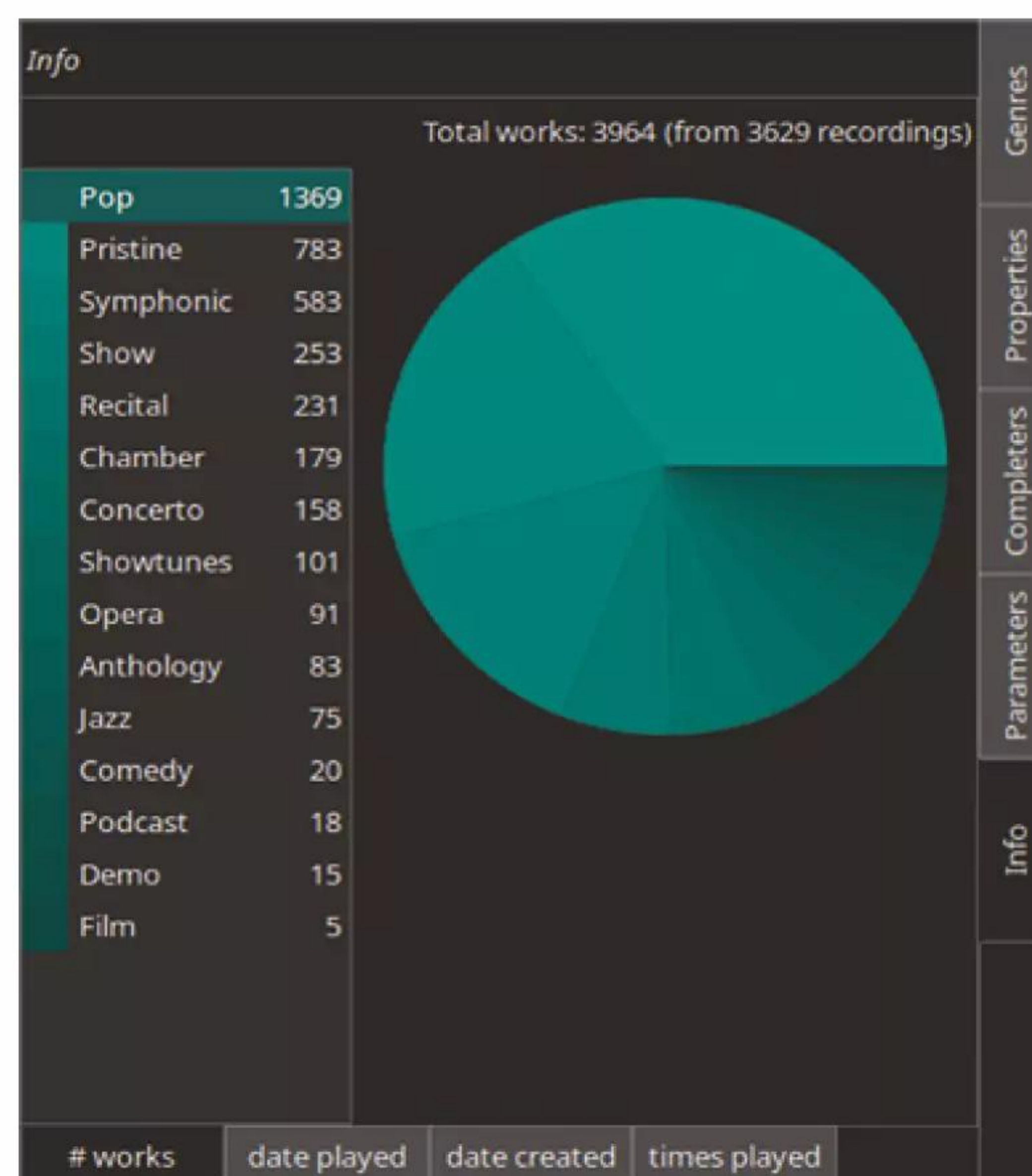

▶ If you need to dive deeper to edit the tags for genres, you're able to do that with Wax-Config

“ Wax is specifically designed for Raspberry Pi 4 because of its quad-core processor ”

button by dragging the column header to the filter button area. Selecting a value with the filter button removes works from the list that do not match that value.”

Dive deeper

While the ‘gears and levers’ are usually hidden, you can enter a robust edit mode that lets you customise metadata, as well as creating new metadata for works. You can use the metadata downloaded from the online sources when creating and editing too.

Specific data is used to filter inside genres – the categories of data can be edited too. “WaxConfig

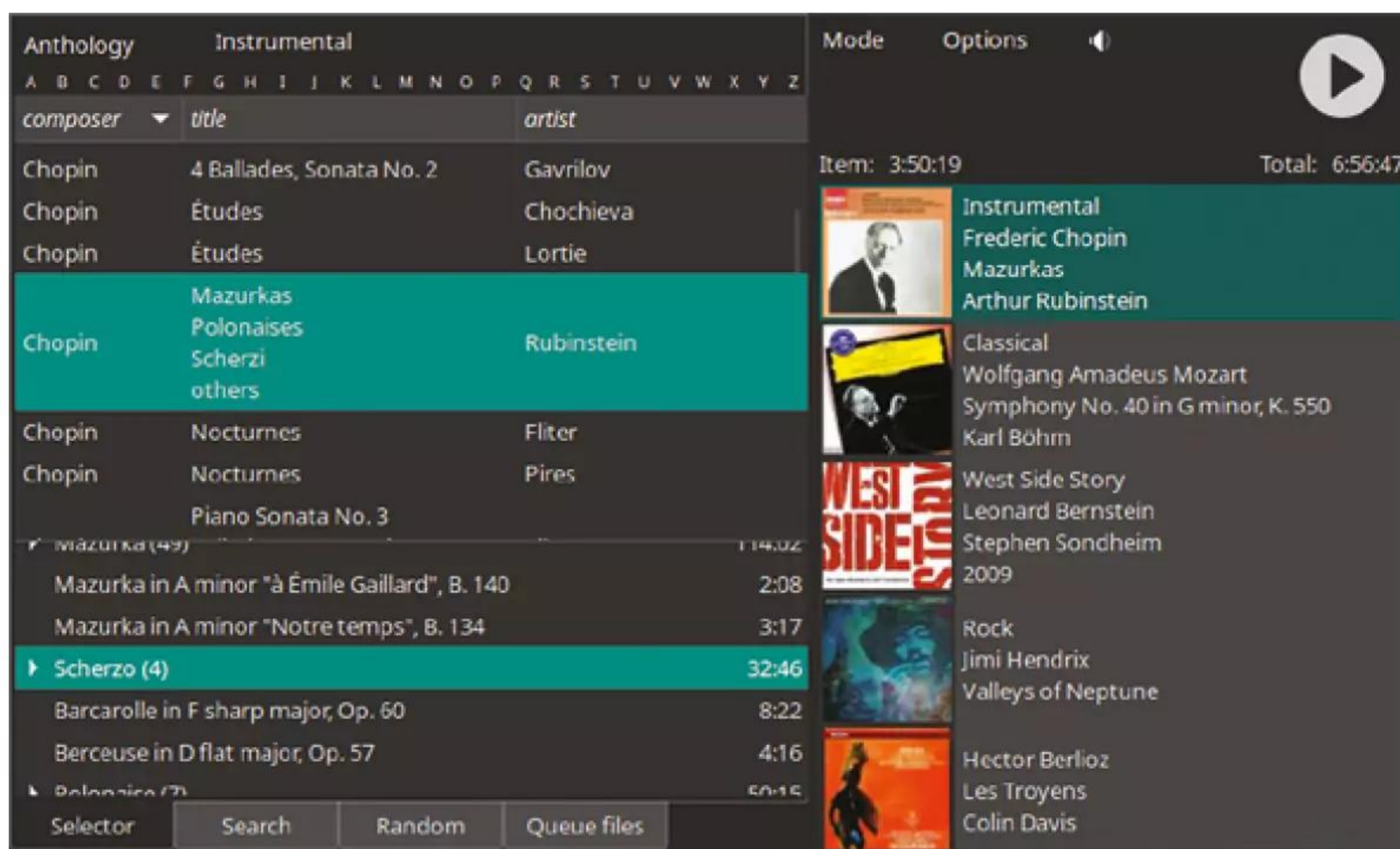

is a separate program used for configuring Wax,” Jeffrey says. “Most importantly, this is where you specify genres, including their name and the primary and secondary keys. The Info page provides information about your collection, including the number of works in each genre.”

You can see an example of this in the image to the left. Jeffrey has put together a very in-depth guide on how to install and setup Wax, as well as going into more depth on how to use it:

magpi.cc/waxdocs. Performance on Raspberry Pi 4 is good too, especially on Jeffrey’s setup.

“I run Wax on a Raspberry Pi 4 with 4 GB of RAM,” Jeffrey tells us. “I use the NanoSound One DAC with the Argon One M.2 case. The NanoSound One DAC uses the TI PCM5122 DAC for high-quality audio output – 112 dB SNR. The Argon case makes it possible to integrate a 2TB SSD which I use for storing my sound archive.”

Even with the high-power audio hardware and no active cooling, the CPU temperature only reached 45C, with a CPU load of 2.4 (of a theoretical maximum of 4.0 due to the quad-core architecture). He even reckons a 2GB Raspberry Pi would do the job just fine.

“Wax makes it easy to find and appreciate the music I want to hear,” Jeffrey says. “Finding a recording of a specific work was often hard and always inconvenient when I had to sort through thousands of LPs and CDs. With Wax, I can make a selection from the comfort of my listening position. I sacrifice nothing for this convenience because Wax presents all the information I need to appreciate the recording -- artist names, for example -- and I am able to explore further, as I used to do by reading record jackets or CD liner notes, by accessing Wikipedia and liner notes in Wax from the comfort of my listening position. Instead of a wall full of recordings, my entire collection now fits in a tiny box powered by a Raspberry Pi.” 

▲ Add works, tracks, or even smartly grouped tracks to your queue

Build a Wax machine



01 You don’t need many components to copy what Jeffrey made – as well as a Raspberry Pi 4 with at least 2GB RAM, it uses an Argon ONE case, NanoSound One Hi-Fi DAC, and a 2TB SSD.



02 The NanoSound One Hi-Fi DAC is specially made to be installed into Argon ONE cases, and connects to the GPIO pins of Raspberry Pi to output high-quality audio from more traditional RCA connectors.



03 As a 2TB SSD is being used for storage, you only need normal sized SD card for Raspberry Pi. Jeffrey has used 2GB here. The SSD goes into the underside of the Argon ONE case, and connects via a USB 3.0 adapter.

SUBSCRIBE TODAY FOR JUST £10

Get 3 issues + FREE Pico W



Subscriber benefits

- ▶ **FREE Delivery**
Get it fast and for FREE
- ▶ **Exclusive Offers**
Great gifts, offers, and discounts
- ▶ **Great Savings**
Save up to 23% compared to stores

Subscribe for £10

- ▶ Free Pico W
- ▶ 3 issues of The MagPi
- ▶ £10 (UK only)

Subscribe for 6 Months

- ▶ Free Pico W
- ▶ 6 issues of The MagPi
- ▶ £30 (UK) \$43 (USA)
- ▶ €43 (EU) £45 (Rest of World)

📞 Subscribe by phone: **01293 312193**

📧 Subscribe online: **magpi.cc/subscribe**

✉ Email: **magpi@subscriptionhelpline.co.uk**

Subscribe for £10 is a UK-only offer. The subscription will renew at £15 every three months unless cancelled. A free Pico W is included with a six-month subscription in USA, Europe and Rest of World.

SUBSCRIBE TODAY AND GET A

FREE Raspberry Pi Pico W

Subscribe in print today and get a **FREE** development board

- ▶ A brand new RP2040-based Raspberry Pi Pico W development board
- ▶ Learn to code with electronics and build your own projects
- ▶ Make your own home automation projects, handheld consoles, tiny robots, and much, much more

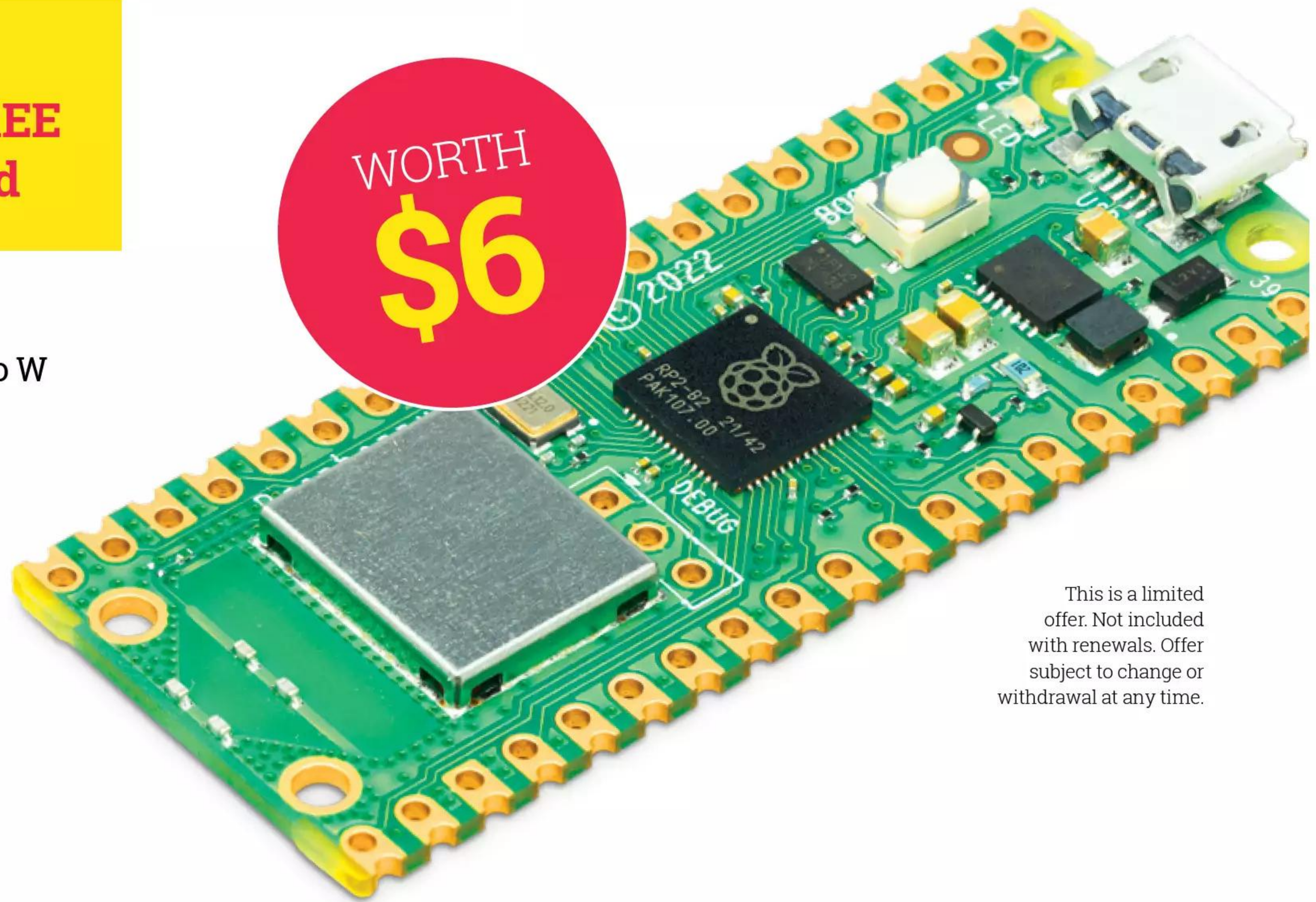

This is a limited offer. Not included with renewals. Offer subject to change or withdrawal at any time.



 Buy now: magpi.cc/subscribe



SUBSCRIBE
on app stores

From **£2.29**

 Available on the
App Store

GET IT ON
 **Google Play**

Gear Guide 2025!

Discover a treasure trove of Raspberry Pi devices and great accessories taking us into a glittering 2025

Rosie Hattersley

Whether, like our very own Features Ed Rob, you regard Christmas as the most wonderful time of the year, or it's simply a period when you get a well-earned break and can finally focus on favourite hobbies, there's lots to love about the tail end of the year. Festivities over, you can clear the decks and spend some quality time with shiny new tech treats, perhaps including some new Raspberry Pi gems that will make your life run that much more smoothly and your leisure hours much more fun. There is a lot going on with Raspberry Pi in 2025. Here's our official guide to what you should put into your shopping basket for next year. 

Buy a Raspberry Pi

Raspberry Pi is really spoiling you with a choice of computing options to suit your pockets as well as your projects

Raspberry Pi 400

→ magpi.cc/raspberrypi400
→ From £67 / \$70

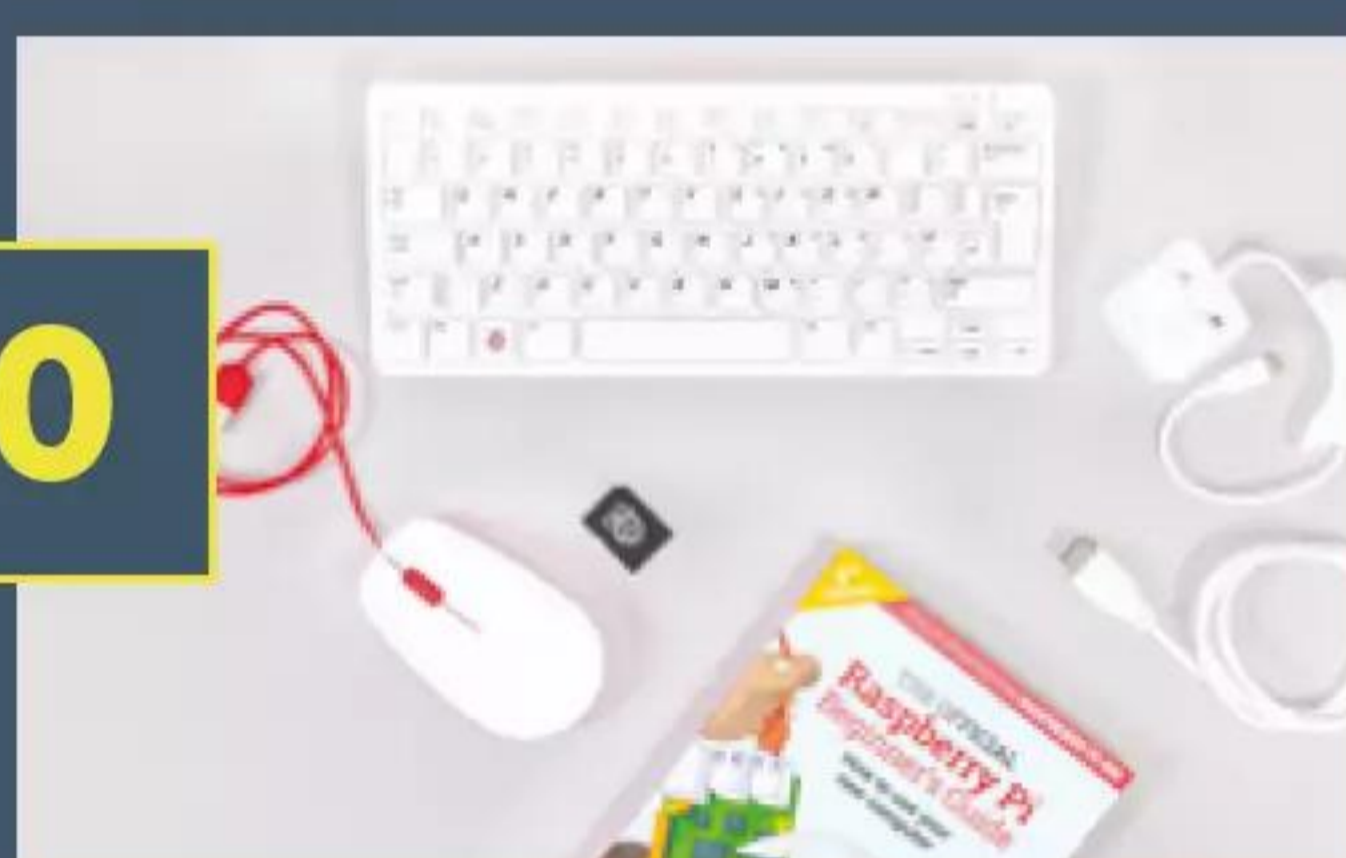

An all-in-one computer that showcases just how well Raspberry Pi 4 works as an alternative to a clunky desktop PC, the Pi 400's striking keyboard conceals its computing hardware. A matching mouse is part of the kit, so you simply need to add an HDMI screen for a neat, space-saving computing setup with 4K video playback. The 4GB Raspberry Pi 4 inside has an exposed 40-pin GPIO header, so plenty of accessories can be attached to the back of the keyboard too.

Raspberry Pi 5

→ magpi.cc/raspberrypi5
→ £47/\$50 (2GB); £57/\$60 (4GB); £77/\$80 (8GB)

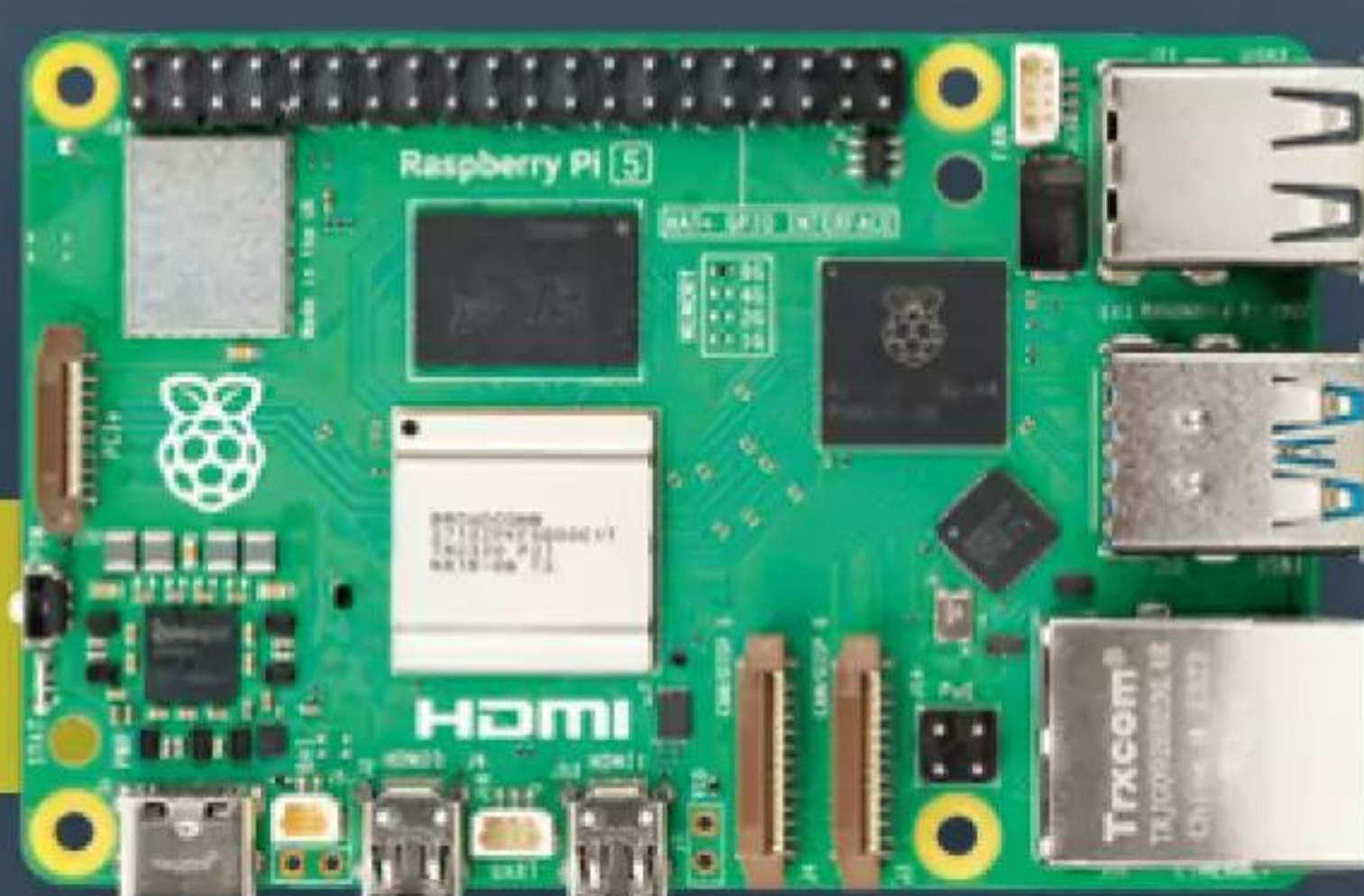

The flagship Raspberry Pi model sports a 2.4MHz quad-core processor, PCI Express and up to 8GB of RAM for the smoothest, fastest computing experience to date. As well as being a great platform for the AI applications, Raspberry Pi 5 is more than twice as powerful as Raspberry Pi 4. It sports USB 3, includes nippy PCI Express with the bandwidth to make proper use of SSD, a real-time clock, gigabit Ethernet, and dual 4K digital display connections. It even has a power button.

Raspberry Pi Pico 2

→ magpi.cc/raspberrypi400
→ From £67 / \$70

This souped-up version of our powerful microcontroller, Pico 2 features PIO (programmable input/output— see magpi.cc/whatispio), optionally comes with wireless connectivity and is ideal for Internet of Things projects to make your home super-smart. The RP2350 chip is faster, has a dual Cortex Arm or RISC-V cores and twice as much onboard RAM as the original Pico.

Raspberry Pi Zero 2 W

→ magpi.cc/zero2w
→ £17 / \$15

Make your home smarter with the Pi Zero 2 W: it is ideal for IoT projects such as motion detectors and security cameras. The tiny Raspberry Pi is both wireless and Bluetooth enabled, so can be used around your home and in small, power efficient projects. With 512MB onboard memory and a 64bit Arm processor, it's a brilliant choice for gaming, drones and tiny robot builds too, see these projects: magpi.cc/zeroblogs.

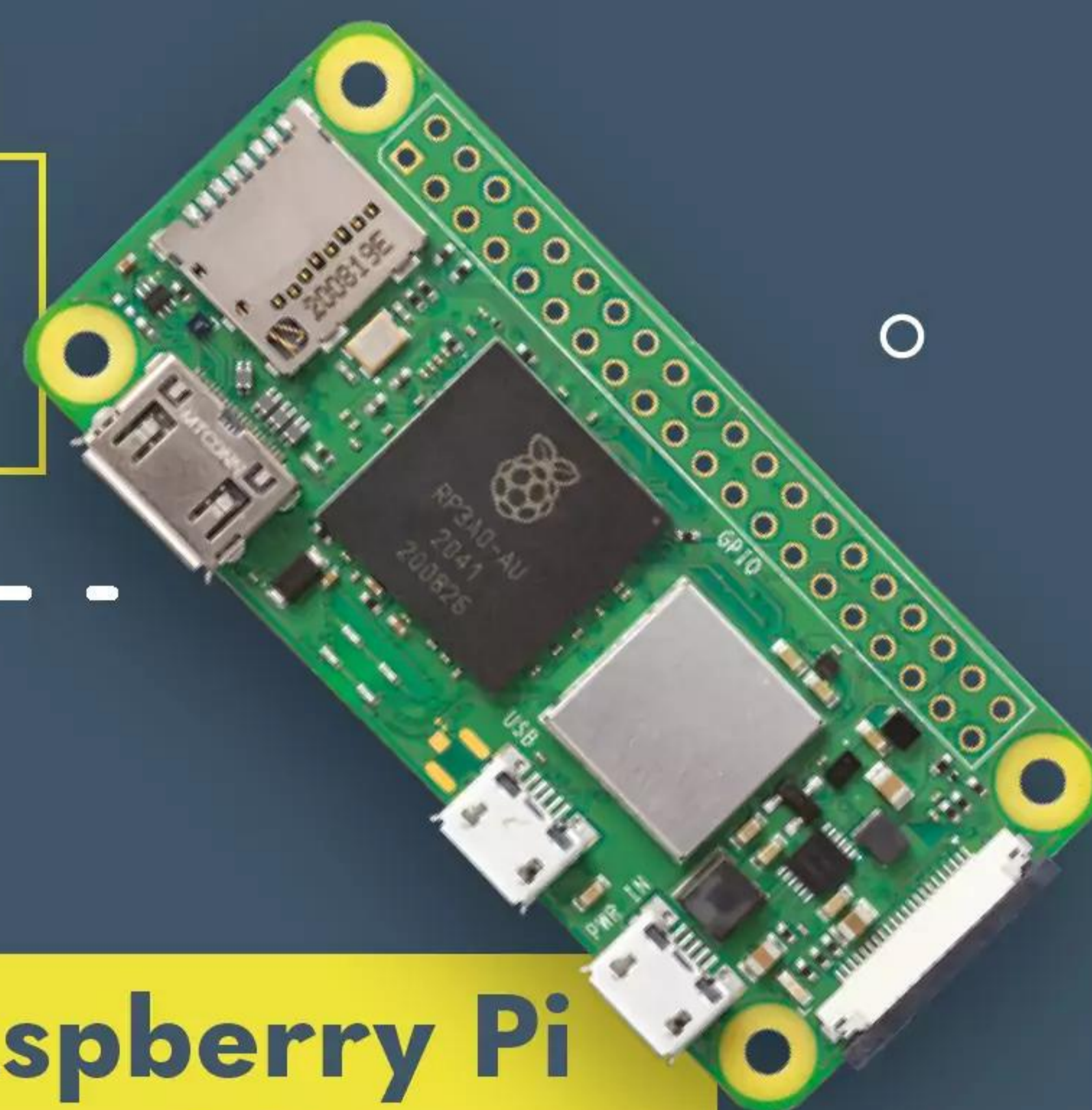

Accessory guide

We've been rolling out lots of lovely Raspberry Pi add-ons over the past few months. What's not to like?

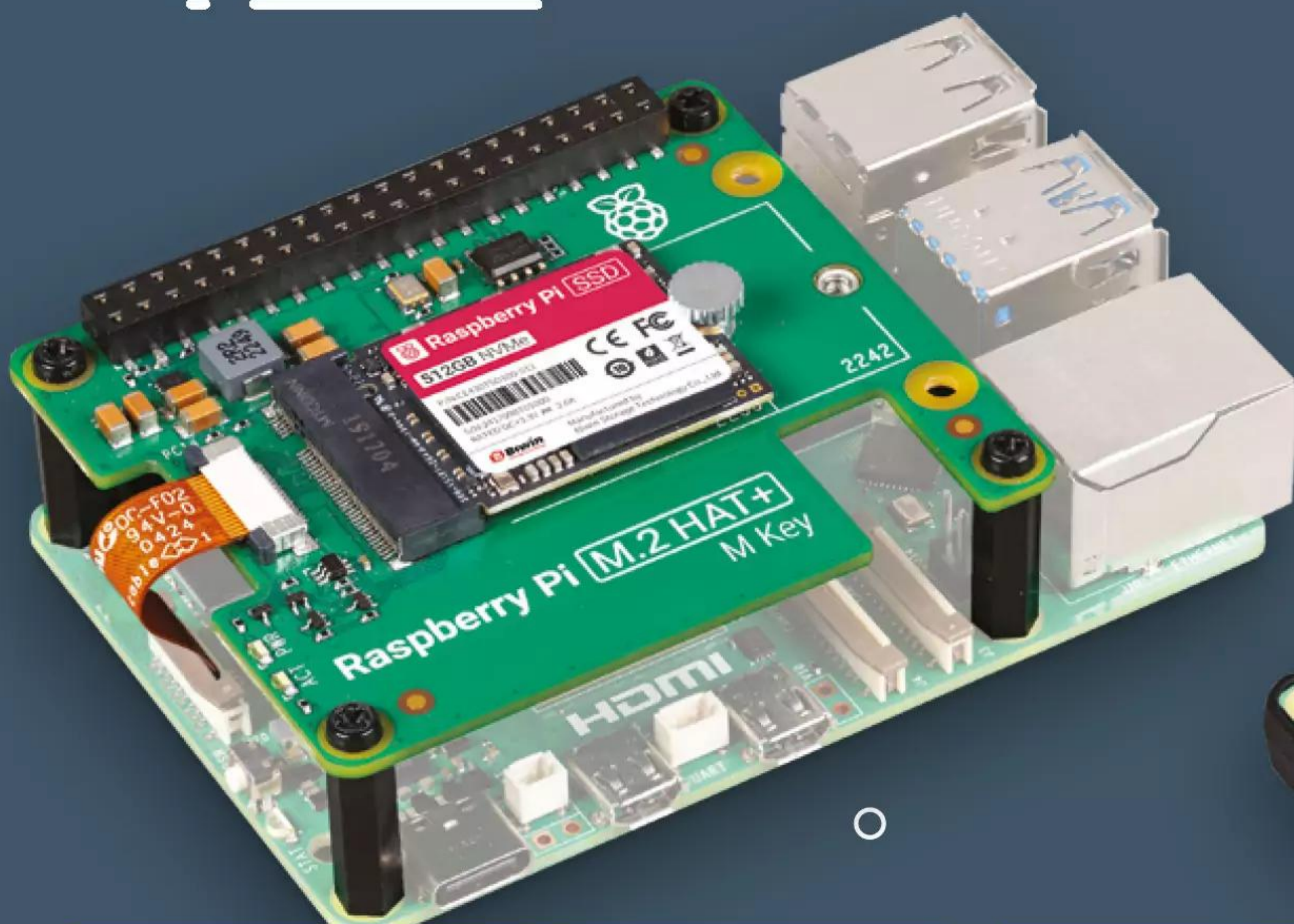

Raspberry Pi SSD Kit

- magpi.cc/ssdkit
- From £37 / \$40

While SD cards have traditionally been used for Raspberry Pi OS, there has long been a clamour for faster, more capacious solid state drives. The new Raspberry Pi SSD Kit comes in 256GB or 512GB versions and is packaged with an M.2 HAT+ for lightning-fast disk access and Raspberry Pi boot-up times.

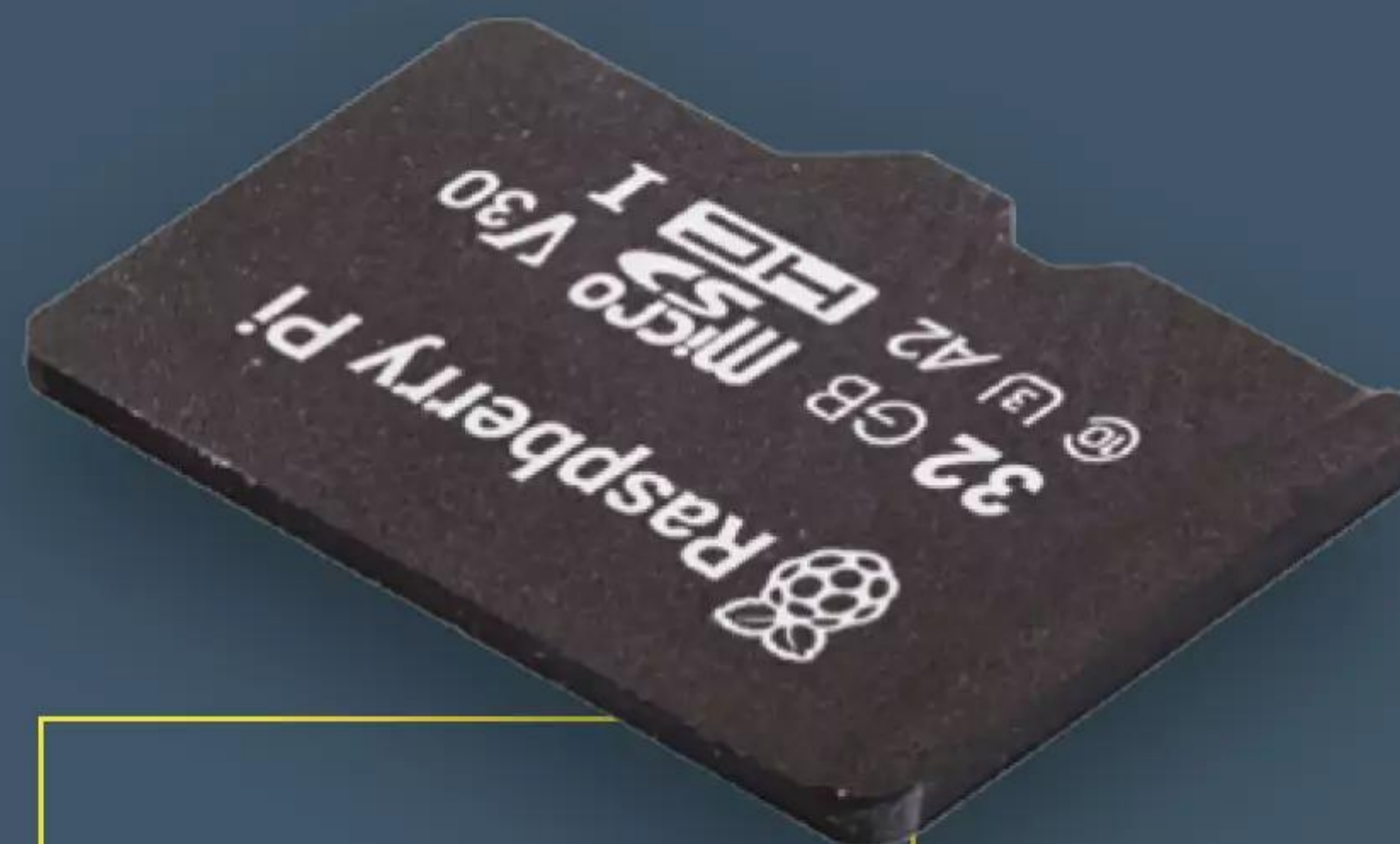

A2 SD Card

- magpi.cc/sdcards
- From £10 / \$13

Our very own branded Class A2 SD cards have been specifically with support for DDR50 and SDR104 bus speeds and command queueing (CQ). You'll need to update to the latest version of Raspberry Pi OS to take full advantage of the extra performance a Class A2 SD card offers. For the technical details see magpi.cc/sdnbumper.

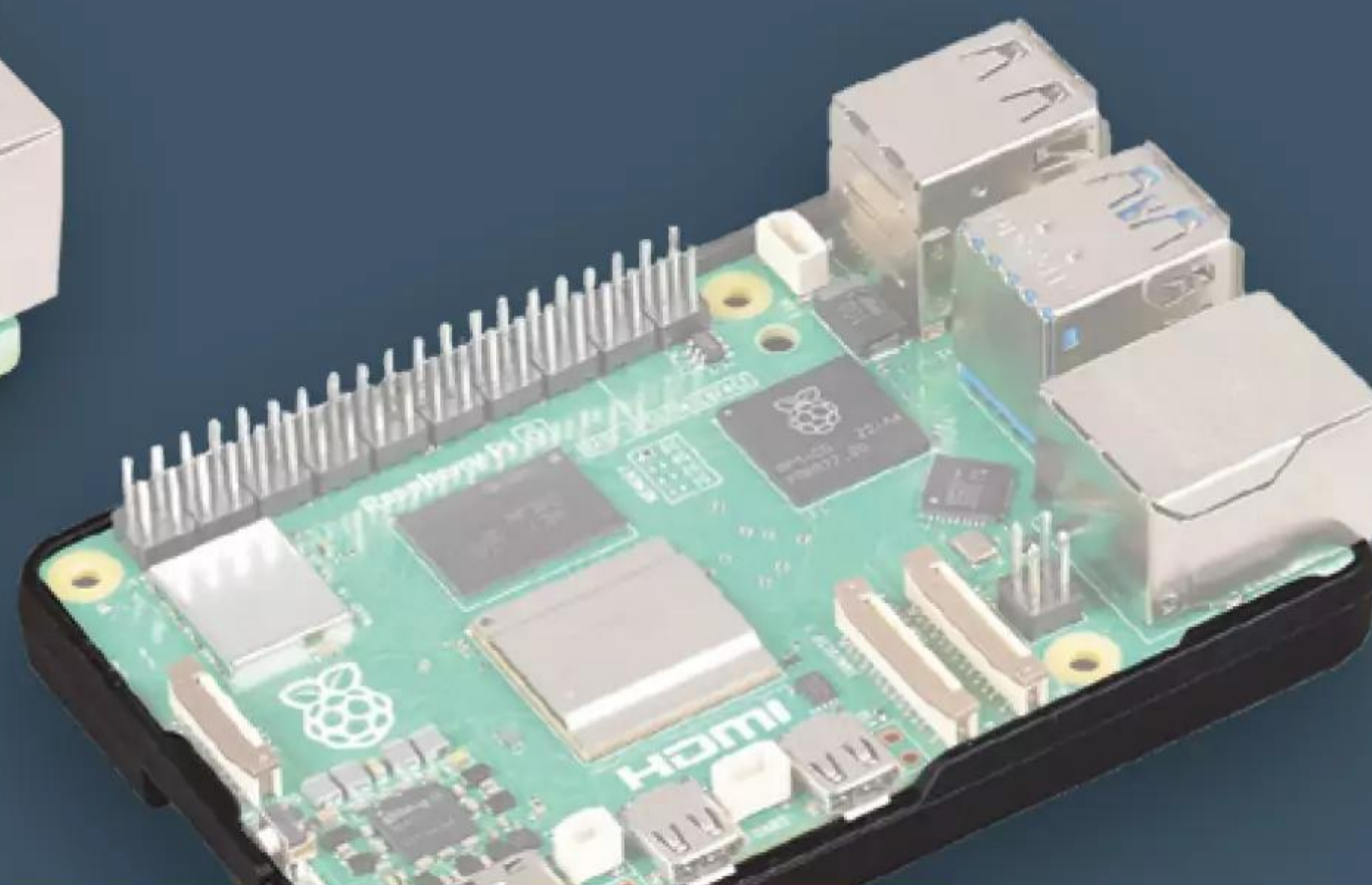

Raspberry Pi Bumper

- magpi.cc/bumper
- £3 / \$3

Protect your precious Raspberry Pi with a cute silicon-rubber surround that ensures knocks don't push it off course. Available in translucent white or solid black, the Raspberry Pi Bumper is a great alternative to a case, ensuring plenty of natural airflow to keep things cool while showing off the computer at the heart of your DIY projects.



M2+ HAT

→ magpi.cc/m2hatplus

→ £12 / \$12

For the fastest data transfers, an M2 SSD that uses the NVMe protocol is just the ticket. Raspberry Pi's official M2+ HAT sits atop Raspberry Pi 5, adding M2's speedy 500MBps transfers to and from NVMe drives as well to the board's existing PCIe 2.0 interface. If AI projects are your thing, you'll really notice the performance difference when using accelerators.

Touch Display 2

→ magpi.cc/touchdisplay2

→ £58 / \$75



This seven-inch capacitive touchscreen boasts an 800×480-pixel IPS display with support for five-finger touch and an onscreen keyboard. The screen connects to your Raspberry Pi via an adapter and can be powered by a ribbon cable with DSI connector and a GPIO with no need for an external power pack, so it can be used as a standalone display for entertainment or IoT duties.



PicoZX Handheld

→ magpi.cc/picozxhandheld

A tiny gaming device inspired by Sinclair's ZX Spectrum could



be the perfect project for those of a certain age who grew up learning computing on the home computing visionary's original. The PicoZX Handheld consists of several custom circuit boards soldered on to a Pico, plus a retro faceplate that conceals the charger, battery and connectors, USB ports and SD card slot.

ePiPod

→ magpi.cc/epipod

Del Hatch's iPod-style music player encases a Raspberry Pi Zero 2 W in a homebrew case (find the STL files here: magpi.cc/epipodstl) with a Waveshare ePaper touchscreen for the display and controls. Once assembled, you will have a portable player that serves up albums from an SD card, doesn't need to be connected to the internet to play them, and offers more than five hours of entertainment before needing a recharge.



Projects

Air Hockey table/ games emulator

→ magpi.cc/minihockey

Maker Chris Downing and his @BitBuilt gaming site co-owner CreshBash spent more than two years designing, 3D-printing and perfecting this 1:5 scale air hockey table. It offers either regular air hockey (first to seven points) or Doom mode for a fiery table lightshow complete with scream effects. Since it uses RetroPie there's also a games emulator mode. The whole crazy caboodle is controlled by Raspberry Pi 4.



Pretty Tide Clock

→ magpi.cc/prettytideclock

This project was inspired by maker Levi wanting to know when to descend his cliff-top home and expect to swim. Even if you have no pressing need to know when and where it will be high or low tide, this gorgeous Raspberry Pi 3B+ project pulls tidal data from the US National Oceanic and Atmospheric Administration API. The 3B+ converts them into PWM values, used for the analogue gauges. The tide clock indicates a rising and receding tides via red and green LEDs either side of its lovely wooden frame.





Argon Neo 5 case

→ magpi.cc/neo5
→ £18 / \$23

Protect your Raspberry Pi from knocks and accidental spills with this hardy case – the latest in Argon’s well-regarded range of cooling accessories for Raspberry Pi is well geared-up for school or industrial use. The aluminium enclosure offers effective CPU and circuitry cooling helped by an onboard, Pi-controlled 30mm PWM fan which is largely silent. Raspberry Pi’s SD card slot can be left accessible when the enclosure is in place, or optionally covered with a screw-on plate to stop anyone messing with your setup.

“The aluminium case offers excellent cooling qualities”



CrowView Note

→ magpi.cc/crowview
→ £128 / \$169

Slide your Raspberry Pi into the side of the CrowView and you’ve got your very own sliver of portable computing convenience. This laptop dock has a socket that is designed especially for Raspberry Pi 5, but can also be used with earlier versions of our favourite computer. Once connected, Raspberry Pi OS runs on the CrowView without further prompting. The dock has a 5000mAh battery pack which powers both dock and Raspberry Pi for up to two hours



Pironman 5 case

→ magpi.cc/pironman5
→ £70 / \$91



With its transparent sides and internal spot lights, plus detailed LED status info, the Pironman 5 reminds us of PC computing kit beloved by modders and overclockers. The aluminium case offers excellent cooling qualities for optimal performance. There are USB 2.0 and USB 3.0 ports, gigabit Ethernet and two HDMI ports and support for both M2 SSD hard drives and has a Raspberry Pi 5 NVMe PCIe peripheral board. Geek out!

Tiny Circuits Thumbby Color gaming device

→ magpi.cc/thumbbycolor
→ £38 / \$45

While the initial appeal of Thumbby Color probably lies in being able to play all sorts of arcade-derived and board games on its teeny 128×128-pixel 16-bit colour screen, the RP2350 microprocessor-powered Thumbby soon lures you in to the world of coding your own games. Reviewing it, *MagPi* editor Lucy remarked that “The real deal is the ability to investigate the API and create games yourself by following the tutorials [to which end] Thumbby has an online Code Editor and a starter guide. Thumbs up all round!



Cool kits & electronics

Tinkering with lights, sensors and diodes is a great way of exploring electronics

Raspberry Pi Pico Advanced Kit

→ magpi.cc/advpicokit

→ £29 / \$38

Electronics kits are something of a classic festive gift, and we can certainly see ourselves getting stuck in to this absolute trove of jumpers, diodes, LEDs, breadboards, sensors, inputs, outputs, robot components and bleepy things. An ideal companion set for Pico owners of any age, it also comes with instructions for several MicroPython Pico projects.



Raspberry Shake

→ raspberrypi.org/shake

→ From £267 / \$349

Citizen scientists will love this incredible device that can measure ground tremors near and far. From volcanoes and earthquakes another continent away to heavy traffic and even the footfall of large crowds, all sorts of seismic events are recorded on Raspberry Shake, and can duly be seen by fellow shake-watchers around the globe. Depending on the version you choose, Raspberry Shake records tremors across one, two or four axes, (vertically and laterally) including underground, under the sea and even overhead.



Raspberry Pi AI Camera

→ magpi.cc/aicamera

→ £63 / \$70

Perhaps the most prevalent phrase of 2024 (closely followed by 'brat'), AI promises to radically alter how we interact, glean information, process data and create and consume images. We couldn't resist designing our own AI camera based around Sony's IMX500 Intelligent Vision Sensor. With its on module AI processor, the Raspberry Pi AI helps you create impressive vision AI applications and neural network models. There's a useful Getting Started guide at magpi.cc/aicamdocs.

The 12.3Mp IMX500 Raspberry Pi AI Camera includes everything you need for Raspberry Pi photography and works with the AITRIOS platform (magpi.cc/aitrios) to create your own classifier detectors, train and label models, and produce brilliant machine-learning projects.

Amazing maker tools

A fully loaded box of tricks will see you through many making adventures



Solder Scroll



- magpi.cc/solderscroll
- Free to 3D print

Hackspace's Andrew Gregory immediately saw the use of Solder Scroll, describing it in his review as a "brilliant device [that] makes soldering more ergonomic by allowing you to dispense any diameter of solder out of an object you hold like a pen". It effectively provides an extra hand to accurately hold in place that tiny object you're attempting to solder. You just need to 3D-print the handy tool using designer Victor's STL files: magpi.cc/scrollstl.

Hozo NeoRuler GO

- magpi.cc/neorulergo
- £46

This digital rolling ruler is accurate to less than 1mm and provides measurements in inches, centimetres, feet, yards and miles. However, it will probably be of most use to *The MagPi* and *Hackspace* readers for tackling curves and awkward shapes when planning 3D and electronics projects, schematics and drafting plans. It has 93 built-in scales. Measurements are automatically saved to the linked Meazor app.



Pimoroni Explorer

- magpi.cc/pimexplorer
- From £34 / \$44

Pimoroni's 'electronic adventure playground for physical computing' is available both as a kit with or without a RP2350 (Pico 2) included, the Explorer goody bag includes sensors to measure moisture, temperature, light and movement, two 60mm wheels, rotation servos and a potentiometer. There's also a breadboard, 2.8in LCD display, speaker, STEMMA connectors and a generous number of analogue and digital connectors.

"Measurements are automatically saved to the linked Meazor app"

xTool S1 Laser Cutter

- magpi.cc/xtools1
- £1799 / \$2334



Laser cutting is a very compelling alternative to 3D printing, involving far less plastic, (although it works on this as well as wood) but also requiring proper precautions. The fully enclosed xTool S1 keeps its potentially dangerous 2W infrared and 20W and 40W blue lasers away from the user, while offering admirable engraving and cutting features. Powerful enough to use with 10mm wood or plywood, this is a great hobbyist machine.



Plasma 2350 LED Light Controller

→ magpi.cc/plasma2350

→ £12 / \$13

Some Raspberry Pi projects offer real coding challenges, but many smart lights and sensor-based ones can be done with a straightforward electronics setup and a suitable microcontroller. The Plasma 2350 is based around the same chip as Raspberry Pi Pico 2 and can illuminate strings of NeoPixel lights or separate RGB LEDs, making for a great fun project that's ideal for those new to coding.



PiDP-11 replica kit

→ magpi.cc/pidp11

→ \$297

Fans of early computers and electronic music may well be familiar with DEC's PDP machines. We covered a Raspberry Pi-enabled rebuild project last issue (magpi.cc/147). This gorgeous replica kit is the next best thing, miniaturising the 1975 model to 6:10 with Raspberry Pi 2, 3, 4 or 5 (optionally) running the Blinkenbone SimH emulator.

CrowPi Educational Kit

→ magpi.cc/crowpi

→ £165 / \$208

Raspberry Pi and electronics kits are a great pairing. The advantage of CrowPi's offering is that they've sourced pretty much all the components you're likely to need: USB-C power input, GPIO ribbon cable, LEDs, sensors, jumpers, cables, and gamepad gubbins – for a fulfilling electronics extravaganza (lesson plans are thrown in too). The whole thing is presented in a sturdy self-contained case along with a breadboard and a 9 inch touchscreen inside the lid.



Bullfrog Synthesizer

→ magpi.cc/bullfrog

→ £450 / \$541

Home computers and electronic music have plenty of shared history, which Bullfrog's subtractive and analogue synth continues. An RP2040 microcontroller takes care of MIDI implementation and is used in a sampler/Loloper voice card. Both digital instrument and educational tool with a 70-page instruction manual, it's a wonderful machine on which to experiment with pitch, timbre and amplitude. Co-designer and DJ/music producer Richie Hawtin proclaims the goal "to both nurture a passion for electronically produced sounds and promote fun".



ArmPi FPV AI Vision

→ magpi.cc/armpifpv

→ £200 / \$300

If you want to give AI a try, you could do far worse than experiment with this programmable robotic arm which you can variously challenge to pick up specific coloured blocks, manoeuvre the arm and transport them from place to place via an app. The arm's six degrees of lateral movement include joints and a robotic 'wrist', while smarts include reporting on temperature, voltage and position.



“It supports TensorFlow and Pytorch”

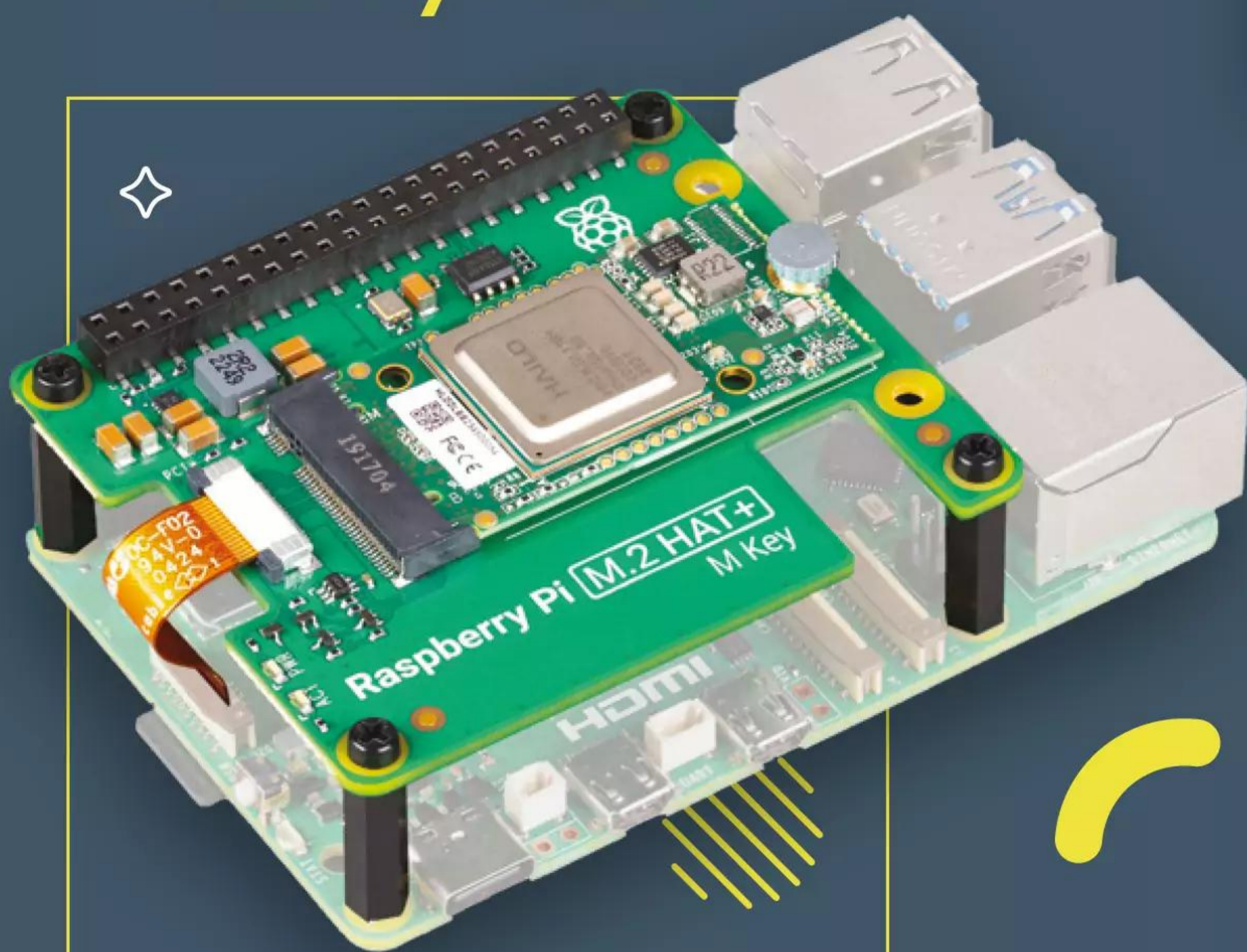

Raspberry Pi AI HAT+

- magpi.cc/aihat
- From £65 / \$70

Machine learning and Raspberry Pi work flawlessly together in this integrated AI accelerator. The Raspberry Pi AI HAT+ features a built-in neural network accelerator, turning your Raspberry Pi 5 into a high-performance, accessible, and power-efficient AI machine. Available with 13 or 26 TOPS performance, it's suited to everything from entry-level applications to complex neural processing.



Pimoroni Inventor 2040 HAT Mini

- magpi.cc/inventorhatmini
- £24 / \$25

Two motor ports and four three-pin servo headers make this HAT ideal for robot projects, for which Pimoroni provides plenty of relevant guidance in this package. However, the inputs for sensors, ADC-compatible GPIO connections, audio and UART ports make this a fairly flexible package for all wannabe inventors.

CM4 XGO Lite Robot Dog Kit



- magpi.cc/cm4xgo
- £429

Robot dogs have become pretty popular, but few have Compute Module (the industrial version of Raspberry Pi) at their heart. The XGO is a pre-constructed metal machine you can control wirelessly via a web browser. It's great for mastering movement using either Python or the simpler Blockly. Your canine companion can walk on all fours, sit up, flex its gripper paw by 15 degrees and use its onboard camera to recognise faces.

Mini Desktop PC

- magpi.cc/minipc
- 3D-printed file

A tiny version of an MS-DOS 286 PC, this charming computer can be assembled by 3D-printing a replica case (magpi.cc/retropccase) and adding a Raspberry Pi plus printed circuit board, 3.5in LDC, power supply and cables. A lovely touch with this nostalgia-inducing build is that its DOSbox emulator software runs from an SD card you pop in what, on the original computer, would have been its floppy disk drive.



Reach a global community!

Advertise in **The MagPi** - The Official Raspberry Pi Magazine

Our readers are passionate about technology and the Raspberry Pi ecosystem. From DIY enthusiasts to professional engineers.

Your advertisement can sit alongside our cutting-edge tutorials, features and reviews. And we have flexible advertising options for a range of different businesses.

Take the next step -
advertise with us today!



Email Charlie Milligan at: charlotte.milligan@raspberrypi.com

Using Python with virtual environments

Raspberry Pi comes with Python and you need to use virtual environments to install packages



MAKER

Nate Contino

Nate is a retrofuturist and writes documentation for Raspberry Pi.

lambdalatitudinarians.org

Raspberry Pi OS comes with Python 3 pre-installed. Interfering with the system Python installation can cause problems for your operating system. When you install third-party Python libraries, always use the correct package-management tools.

On Linux, you can install python dependencies in two ways:

- use apt to install pre-configured system packages
- use pip to install libraries using Python's dependency manager in a virtual environment

Install Python packages using apt

Packages installed via apt are packaged specifically for Raspberry Pi OS. These packages usually come pre-compiled, so they install faster. Because apt manages dependencies for all packages, installing with this method includes all of the sub-dependencies needed to run the package. And apt ensures that you don't break other packages if you uninstall.

For instance, to install the Python 3 library that supports the Raspberry Pi Build HAT, run the following command:

```
sudo apt install python3-build-hat
```

To find Python packages distributed with apt, use apt search. In most cases, Python packages use the prefix python- or python3-: for instance, you can find the numpy package under the name python3-numpy.

Install Python libraries using pip

In older versions of Raspberry Pi OS, you could install libraries directly into the system version of Python using pip. Since Raspberry Pi OS Bookworm, users cannot install libraries directly into the system version of Python.

Instead, install libraries into a virtual environment (venv). To install a library at the system level for all users, install it with apt.

Attempting to install a Python package system-wide outputs an error similar to the following:

```
pip install buildhat
```

```
error: externally-managed-environment
```

```
× This environment is externally managed
  To install Python packages system-wide, try
  apt install
  python3-xyz, where xyz is the package you
  are trying to
  install.
```

```
If you wish to install a non-Debian-
packaged Python package,
  create a virtual environment using python3
-m venv path/to/venv.
```

```
Then use path/to/venv/bin/python and path/
to/venv/bin/pip. Make
  sure you have python3-full installed.
```

```
For more information visit http://rpt1.
```

You'll Need

- Raspberry Pi
- Raspberry Pi OS

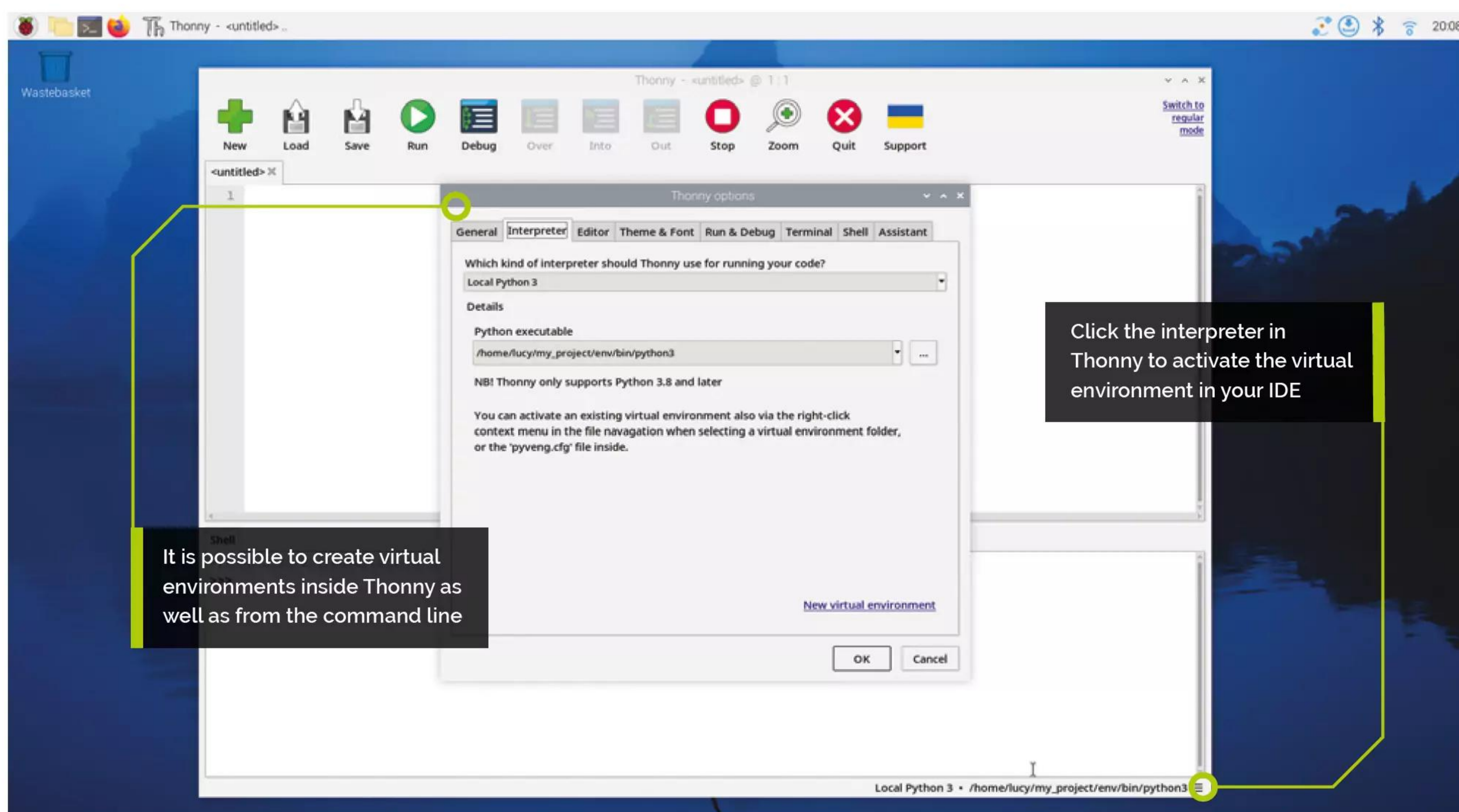

io/venv

note: If you believe this is a mistake, please contact your Python installation or OS distribution provider. You can override this, at the risk of breaking your Python installation or OS, by passing `--break-system-packages`.

hint: See PEP 668 for the detailed specification.

Python users have long dealt with conflicts between OS package managers like `apt` and Python-specific package management tools like `pip`. These conflicts include both Python-level API incompatibilities and conflicts over file ownership.

Starting in Raspberry Pi OS Bookworm, packages installed via `pip` must be installed into a Python virtual environment (venv). A virtual environment is a container where you can safely install third-party modules so they won't interfere with your system Python.

Use pip with virtual environments

To use a virtual environment, create a container to store the environment. There are several ways you can do this depending on how you want to work with Python:

per-project environments

Many users create separate virtual environments for each Python project. Locate the virtual

environment in the root folder of each project, typically with a shared name like `env`. Run the following command from the root folder of each project to create a virtual environment configuration folder:

```
python -m venv env
```

Before you work on a project, run the following command from the root of the project to start using the virtual environment:

```
source env/bin/activate
```

You should then see a prompt similar to the following:

▼ Attempting to install packages with `pip` causes an error in Raspberry Pi OS Bookworm

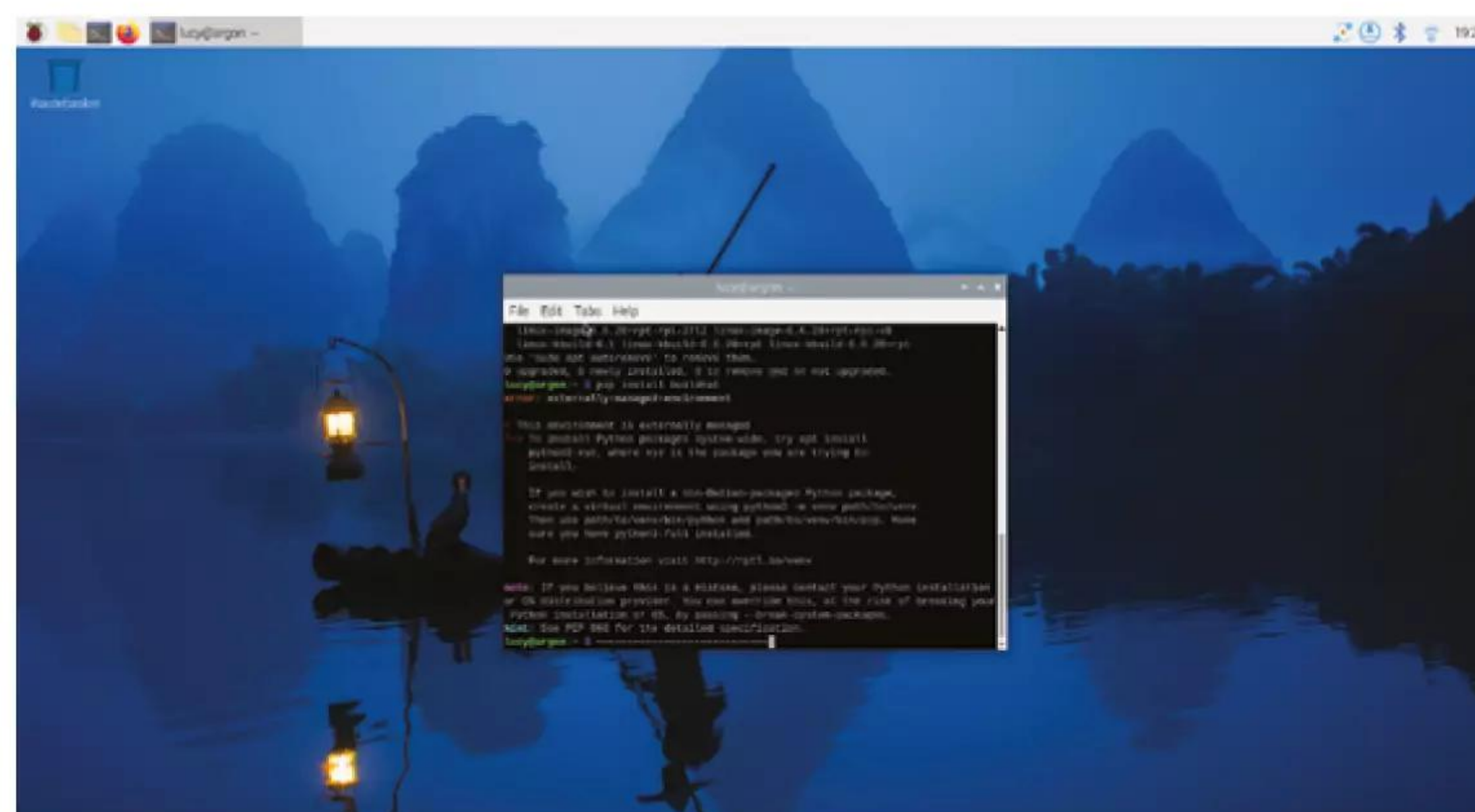

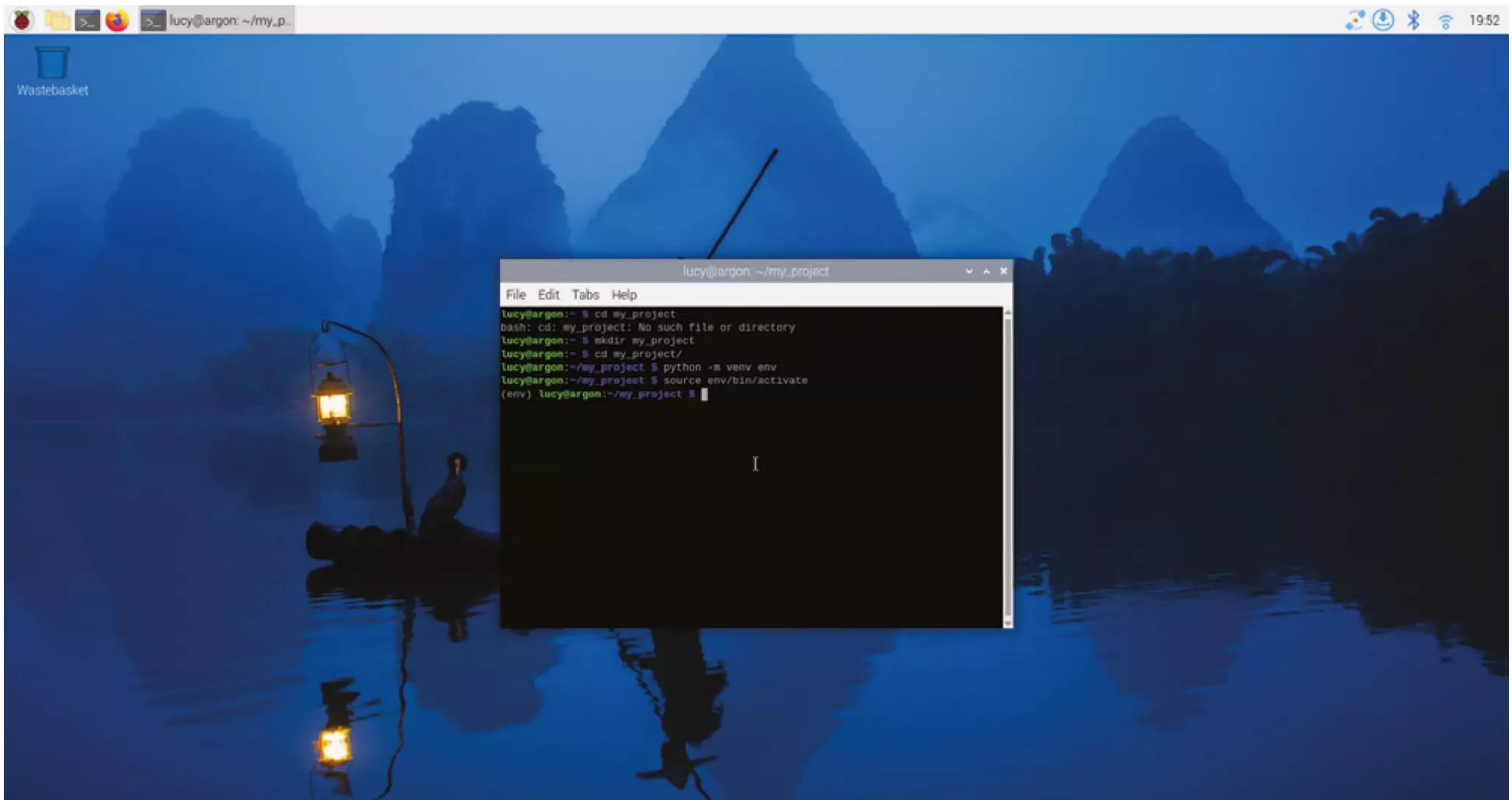

▲ Create a virtual environment in a project folder to install packages local to that project

`(.env) $`

When you finish working on a project, run the following command from any directory to leave the virtual environment:

`deactivate`

per-user environments

Instead of creating a virtual environment for each of your Python projects, you can create a single virtual environment for your user account. Activate

“ We recommend Thonny for editing Python code on the Raspberry Pi ”

that virtual environment before running any of your Python code. This approach can be more convenient for workflows that share many libraries across projects.

When creating a virtual environment for multiple projects across an entire user account, consider locating the virtual environment configuration files in your home directory. Store

your configuration in a folder whose name begins with a period to hide the folder by default, preventing it from cluttering your home folder.

Use the following command to create a virtual environment in a hidden folder in the current user’s home directory:

`python -m venv ~/.env`

Run the following command from any directory to start using the virtual environment:

`source ~/.env/bin/activate`

You should then see a prompt similar to the following:

`(.env) $`

To leave the virtual environment, run the following command from any directory:

`deactivate`

Create a virtual environment

Run the following command to create a virtual environment configuration folder, replacing <env-name> with the name you would like to use for the

virtual environment (e.g. env):

```
python -m venv <env-name>
```

Enter a virtual environment

Then, execute the `bin/activate` script in the virtual environment configuration folder to enter the virtual environment:

```
source <env-name>/bin/activate
```

You should then see a prompt similar to the following:

```
(<env-name>) $
```

The `(<env-name>)` command prompt prefix indicates that the current terminal session is in a virtual environment named `<env-name>`.

To check that you're in a virtual environment, use `pip list` to view the list of installed packages:

```
(<env-name>) $ pip list
Package      Version
-----
pip          23.0.1
```

```
setuptools 66.1.1
```

The list should be much shorter than the list of packages installed in your system Python. You can now safely install packages with `pip`. Any packages you install with `pip` while in a virtual environment only install to that virtual environment. In a virtual environment, the `python` or `python3` commands automatically use the virtual environment's version of Python and installed packages instead of the system Python.

Exit a virtual environment

To leave a virtual environment, run the following command:

```
(<env-name>) $ deactivate
```

Use the Thonny editor

We recommend Thonny for editing Python code on the Raspberry Pi.

By default, Thonny uses the system Python. However, you can switch to using a Python virtual environment by clicking on the interpreter menu in the bottom right of the Thonny window. Select a configured environment or configure a new virtual environment with `Configure interpreter`. 

Top Tip

Tip

Pass the `--system-site-packages` flag before the folder name to preload all of the currently installed packages in your system Python installation into the virtual environment.

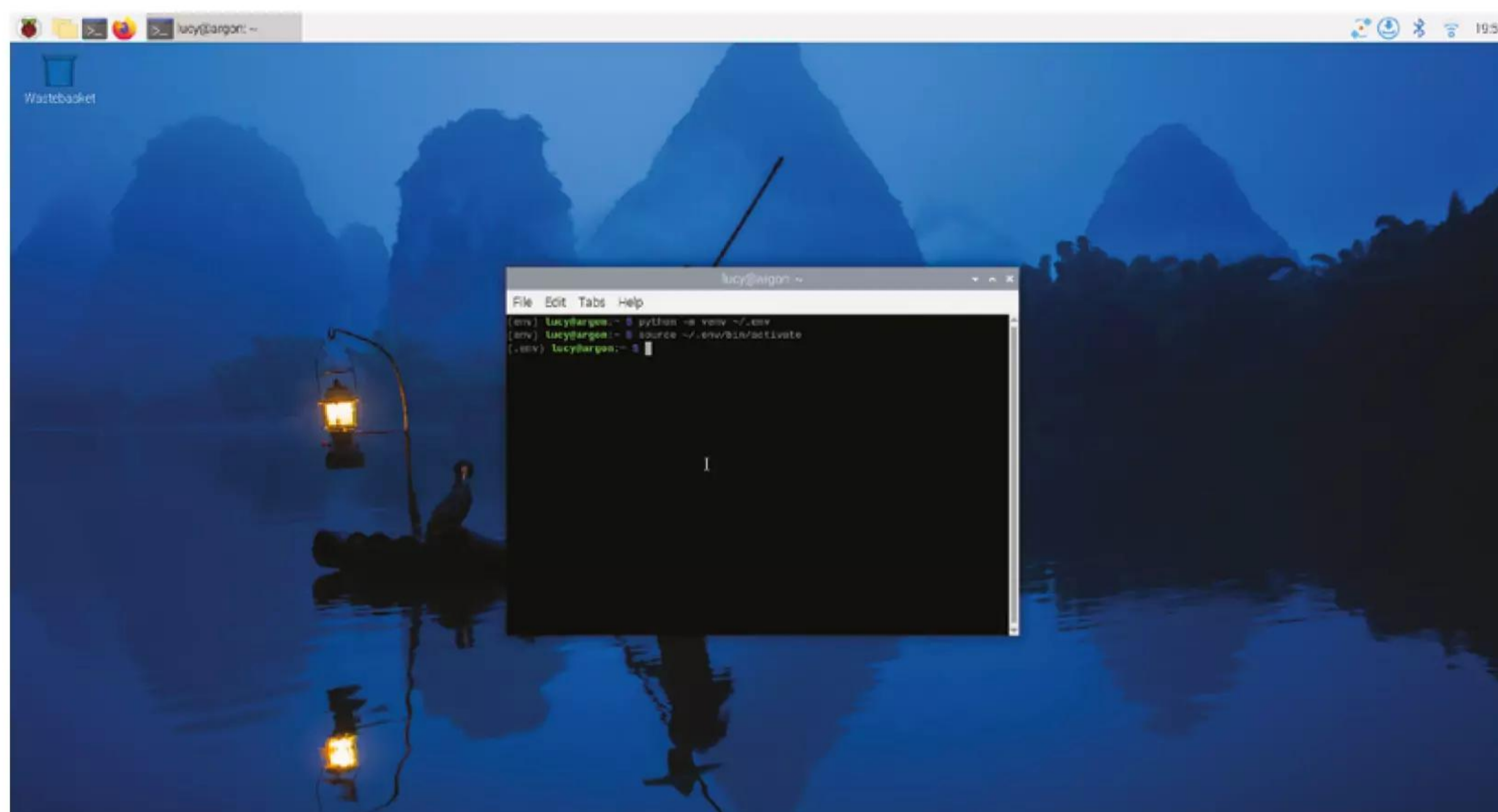

◀ Add a virtual environment to your home directory to use it in multiple projects and share the packages

Build your own streaming media server



Access your music, digital-download movies, ebooks and more using Jellyfin, a free, open-source media server with a slick web interface

MAKER

K.G. Orphanides

KG has been hoarding media since the late 1990s and sees no reason to stop now, just because everything's gone digital.

[twoot.space/@owlbear](https://twitter.com/owlbear)



Warning!
Copyright

UK law does not allow you to copy CDs, DVDs, or other media discs. This feature includes recommendations for numerous services that will sell you downloadable music and movies.

magpi.cc/copyright

If you have a large media library, having it trapped on a single computer is increasingly frustrating if your family uses multiple devices, and this is part of why online streaming is convenient. The Jellyfin media server brings this convenience to your home media collection. It's not legal to rip CDs and DVDs in the UK, but you can buy digital music online from places like Bandcamp, HDTracks, Steam, Mirlo, Apple Music and even Amazon.

Video is a bit harder, but many independent filmmakers and comedians allow you to buy their videos. Go Faster Stripe (gofasterstripe.com) has an excellent range of UK stand-up comedy and Vimeo On Demand section (magpi.cc/vimeood) lets you buy films to download, while enthusiasts for French cinema can buy films from Cinemutins (cinemutins.com).

01 Media hosting

Before you set up your streaming media server, you'll need to set up somewhere to store your media. There are so many different options for this, that it's somewhat beyond the scope of this tutorial. We've hosted ours on a Synology NAS device on our local network, but you can also use

an M.2 HAT (magpi.cc/m2hat) on Raspberry Pi 5 to add a large amount of local storage and create a fully self-contained media server. You can also create a Samba/SMB/CIFS share on any server or appliance that is permanently on and connected to your local network.

02 Organising your movies

Jellyfin works best if you structure your media in the right way, allowing it to correctly apply metadata. The documentation (magpi.cc/jellydocs) provides extensive details on how this is best carried out for each media type.

It can read media identifiers, notably online media database codes, from both file and folder names, so, per its example you could name a file 'Film Name (2010) [imdbid-tt0106145].mp4' or have it in a folder called 'Film Name (2018) [tmdbid-65567]'. Multiple versions of the same file, at different resolutions or even in different cuts, can be placed in a single folder for that film, and you'll be able to select from them when playing back. The documentation also details Jellyfin's preferred conventions for naming extras.

Series episodes should be labelled into a folder names for the series, along with its year and,

You can name your libraries whatever you please. All the films we've added here come from DRM-free video-on-demand services

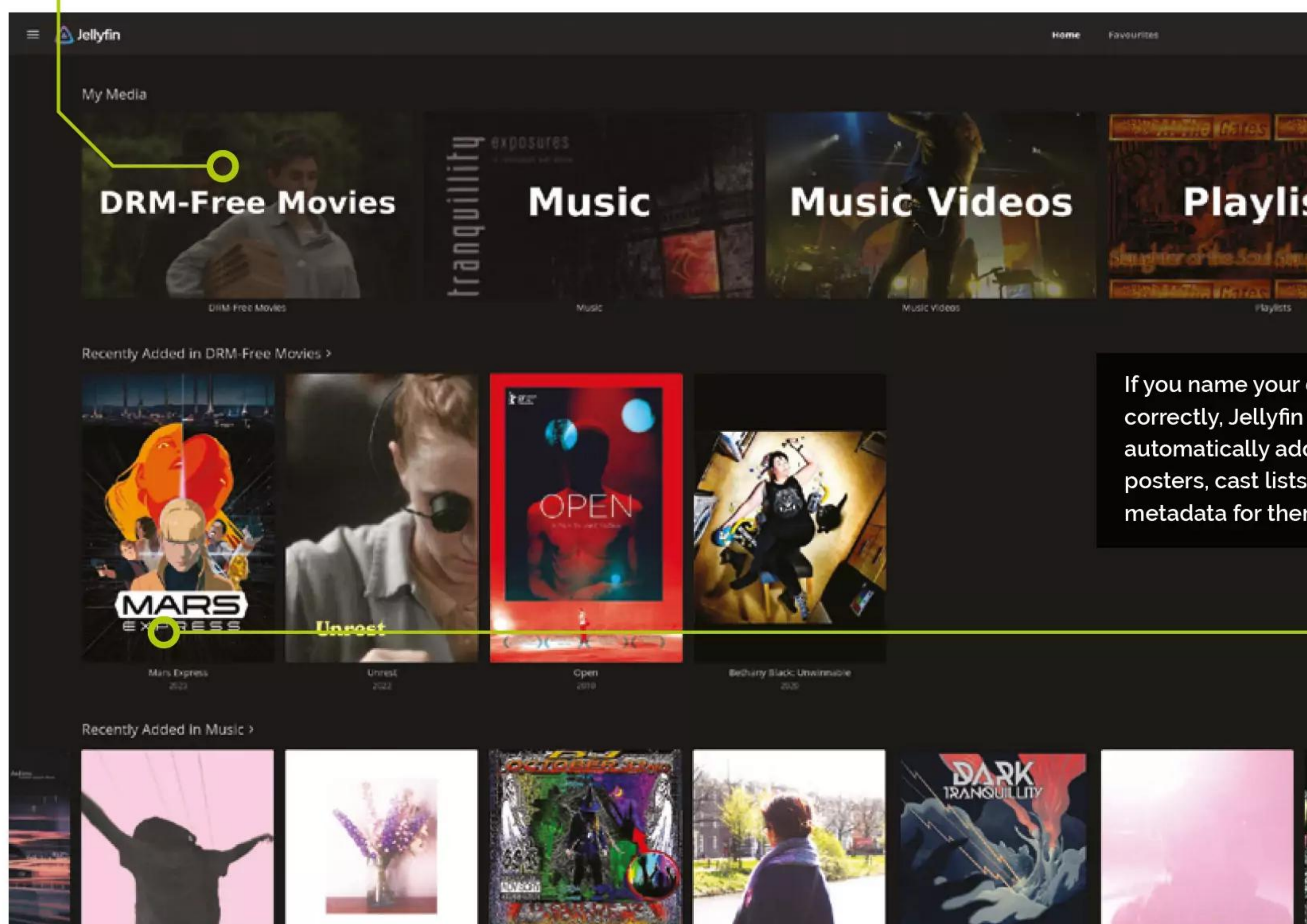

You'll Need

- ▶ M.2 HAT for Raspberry Pi 5 (optional)
- ▶ Network attached storage (optional)

If you name your directories correctly, Jellyfin will automatically add movie posters, cast lists and other metadata for them

- ▼ It's worth taking the time to at least add films to directories named for their title and year – this is sufficient to provide all the data you see here

if you wish to use it, online media database identifier, and then folders below that for each season, with files in those labelled as something like 'Series Name S00E01.mkv'.

03 Organising your music

You'll want to do something for your music, with a structure that looks like 'Artist Name > Album Name > XX Track Name.format', where XX is the track number. You can do this manually, and Jellyfin is pretty forgiving as long as you have the folder structure the way it likes. If you don't want to manually rearrange everything, consider using Beets (beets.io) to rename and structure files based on their MusicBrainz entries. Fortunately, even if you don't get the ordering right initially, you can have Jellyfin rescan your media folders at any point.

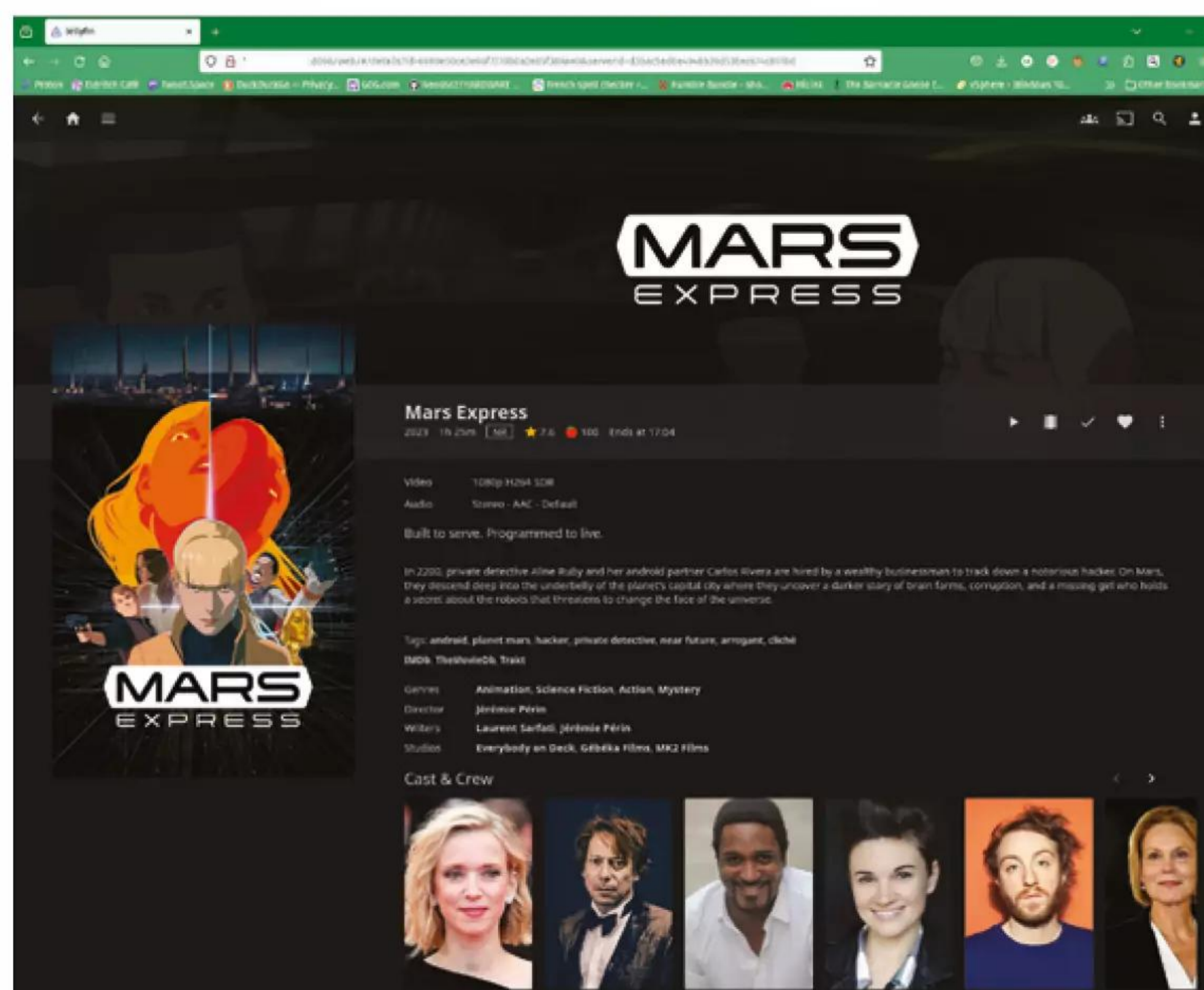

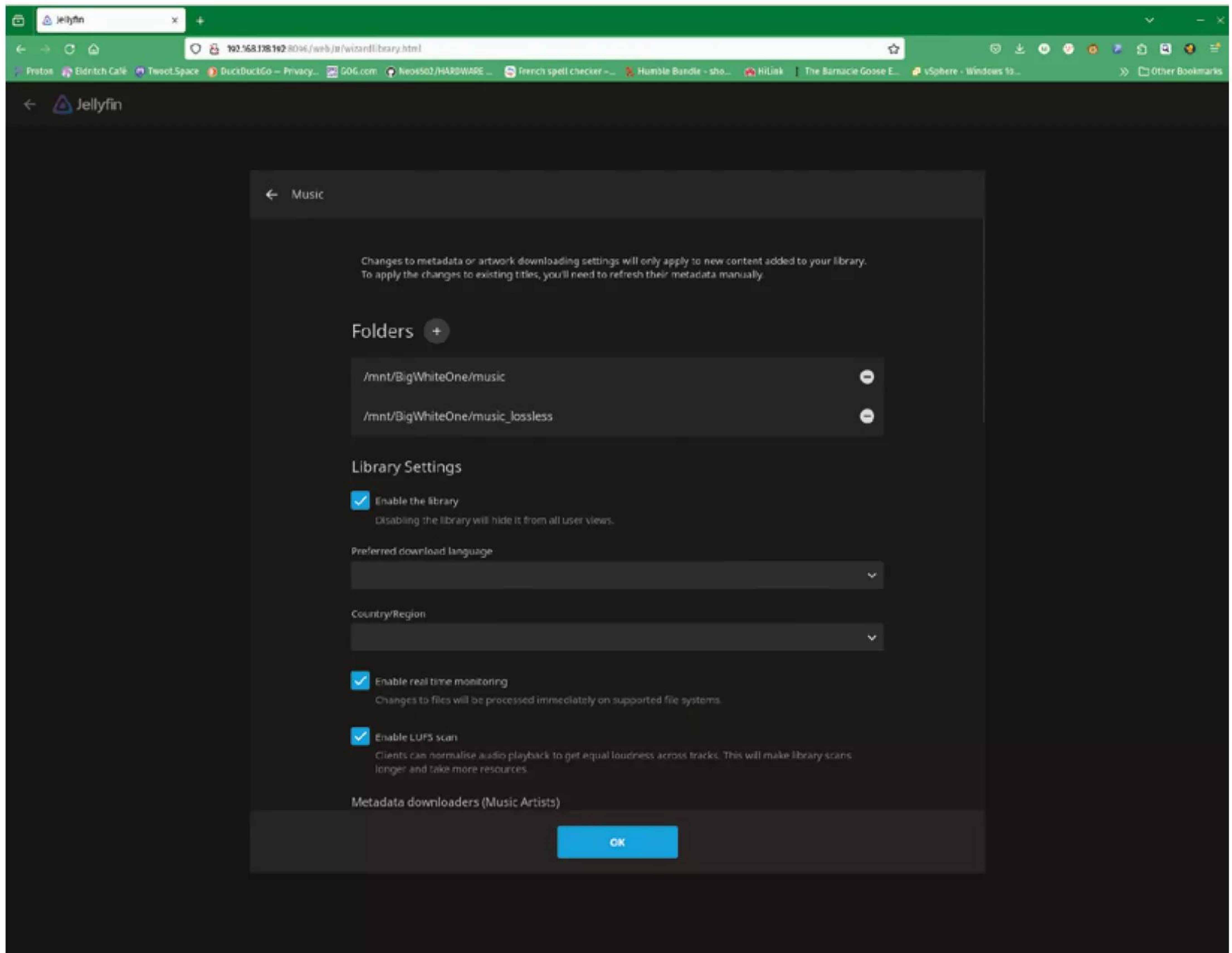

► You're prompted to add your media libraries at setup time. You can add as many directories as you like to each library

04 Have Beets relabel your music

You can run Beets with any source and target directory location, whether you're storing music in a local folder or on a network share.

```
$ sudo apt install beets
$ beet config -p
```

This will spit out the address of a Beets config

“ With your media organised, actually installing Jellyfin could hardly be any simpler ”

file: **/home/pi/.config/beets/config.yaml** in our case. The next command will allow us to edit it so that we can tell it where to put our reorganised music and whether to move or copy our files.

```
$ beet config -e
```

This will open your default text editor, allowing you to define the directory you'll be exporting sorted music to and keeping its database in. We've

also told it to move, rather than copy files, as we have had limited space. Setting move to 'no' is the better option if you also wish to retain your audio files in their original structure. Note that tabs are not supported in the yaml file, only spaces.

```
directory: ~/Music/Ordered
library: ~/Music/Ordered/musiclibrary.db
move: yes
```

If your target directory doesn't already exist, you'll need to create it:

```
$ mkdir ~/Music/Ordered
And now import your music:
$ beet import /path/to/your/music
```

05 Install Jellyfin

With your media organised, actually installing Jellyfin could hardly be any simpler. Once you've installed and updated Raspberry Pi OS, run the following command to add Jellyfin's official Debian repository and fully install its server and web interface components:

```
$ sudo apt update && sudo apt upgrade
```



```
$ curl -s https://repo.jellyfin.org/install-debuntu.sh | sudo bash
```

With that done, you'll need to mount some media. We don't recommend using directories on your OS SD card's root, as Jellyfin can be temperamental about mounting these, although you could manually create a second partition on a large SD card.

06 Connect a media share

```
$ sudo mkdir /mnt/Share
$ sudo mount -t cifs -o
username=RemoteUserName //x.x.x.x/ /mnt/share/
```

Assuming your target share directory shows up as planned, we'll now add this to Raspberry Pi's fstab so that it's automatically mounted when your Jellyfin server boots.

```
$ sudo nano /etc/fstab
//x.x.x.x/media /mnt/share/ cifs guest,
uid=YourUserName, file_mode=0777,dir_
mode=0777,noperm 0 0 x-systemd.mount-
timeout=45
```

reboot

With all that done, your media server is ready to set up and you should now be able to access it from any device on your local network that's capable of running a web browser. By default, Jellyfin serves HTTP traffic on port 8096.

Get the IP address of your Raspberry Pi and note it down for the next step, because you'll need that to access your new media server.

```
$ ip a
```

07 Set up admin access

In a browser on another device, visit: [http://\[IP address\]:8096/](http://[IP address]:8096/). If everything's installed correctly, you should be presented with a page that reads "Welcome to Jellyfin!"

Select your language from the pulldown menu – English (United Kingdom) is an available option. You'll then be asked to set up your Jellyfin admin account on a page that's slightly ambiguously titled "Tell us about yourself".

This account will be able to add media sources, create other user accounts and access the server's administration interface, potentially from outside your network if you set up remote access, so make sure it gets a strong password.

08 Connect your media

With that step done, it's time to set up your media libraries. Click Add Media Library, choose the content – metadata application works best for single-type content, so split up your movies and your shows into separate libraries and storage directories if possible. Name each library as you please, and add folders to it. Once you've added everything you want – you can always add more later, click Next.

Select your primary metadata language. You can set individual languages per library as needed, which is handy for multilingual users.

09 Optional networking features

You'll next be prompted to consider a couple of networking questions. The Configure Remote access options by default allow remote connections to the server – untick this if you don't plan on ever enabling access from the broader internet. You can optionally enable automatic

▼ An admin dashboard allows you to see recent activity on the server, manage your libraries, your users and a range of advanced settings

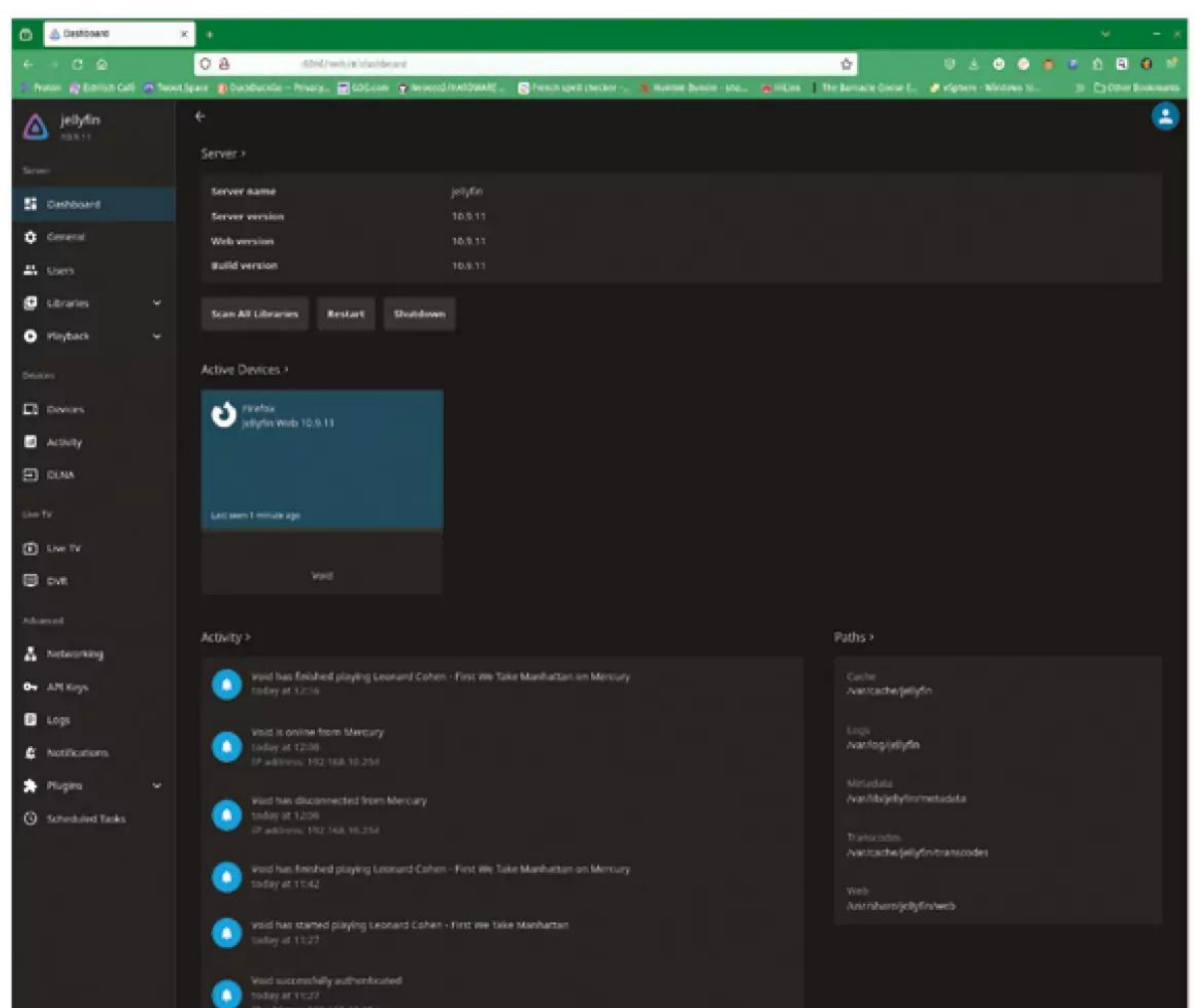

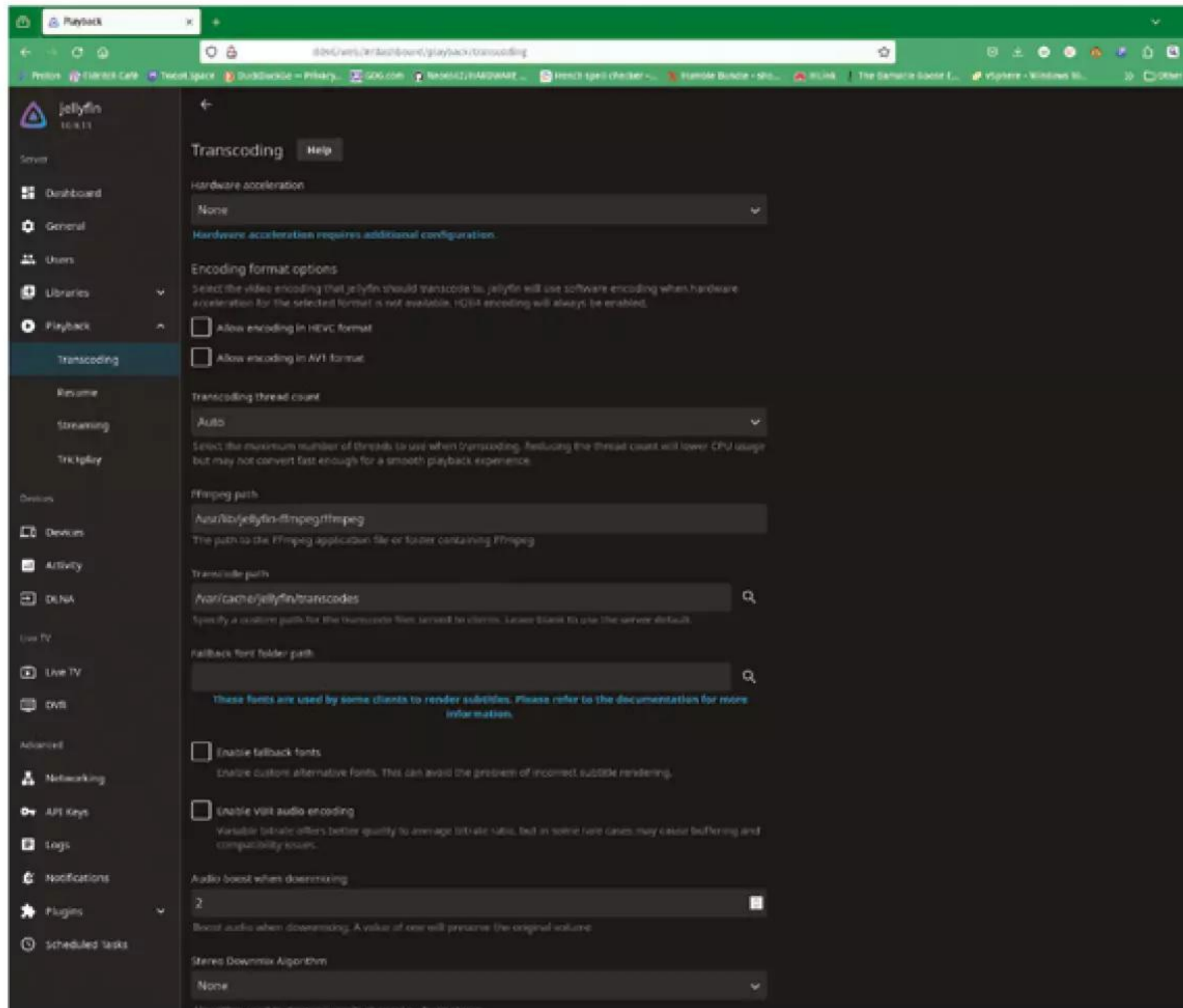

▲ A range of transcoding options are available if you want to have Jellyfin attempt to reduce media file sizes for smoother streaming

UPnP (Universal Plug and Play) port mapping, although this media streaming feature set isn't supported by all routers these days, so it's off by default.

With that, you're done. Jellyfin has already begun indexing your media collection in the background.

10 Adding users, parental controls

You can create profiles for every member of your household via the admin dashboard, and configure what their access privileges are, giving them admin rights, the ability to

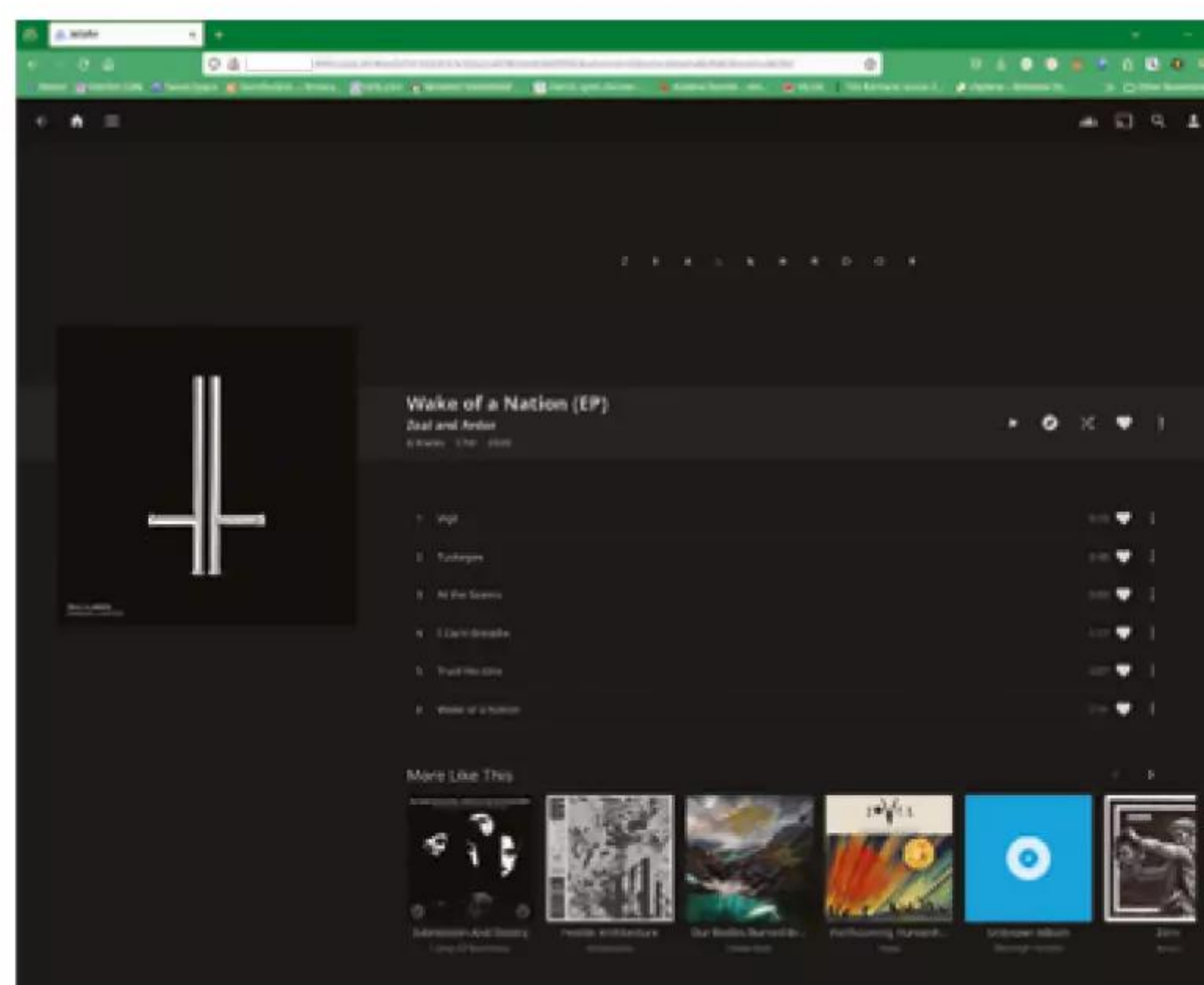

▶ Jellyfin's interface for serving music is just as slick as its video counterpart, making it ideal if you have a large collection you wish to access from any device

download media to a local device, or limiting their access to only certain media libraries. This is one way to approach kids' accounts. If you've got everything set up with accurate metadata, you can use the parental controls alongside age ratings to ensure that younger users see only appropriate material, as well as blocking content that doesn't have a rating. You can also use tags to allow or block content, and create an access schedule so that the user can't play media outside specified hours. Every user gets their own viewing history and favourites,

11 Remote control

You can even access Jellyfin while you're travelling or simply when using a different network at home, such as your mobile broadband connection. By default it makes itself available

“ Use the parental controls alongside age ratings to ensure younger users see only appropriate material ”

via HTTP port 8096, so you'll want to forward that port from the external static IP address provided by your ISP to the IP address of your Jellyfin server. Make sure that you give your users strong passwords if you're going to make Jellyfin available externally.

12 Watch together

You can also invite other members of your household to have a digital watch party using the Groups feature, which will keep multiple streams of a movie in sync with the person who's running the group-watch, making it easy for you to drop into family movie nights while you're travelling.

You can also cast Jellyfin to compatible media receivers. Although the symbol is the same that you'll see on services that support Google's ChromeCast standard, the two are not compatible.

We'll talk about setting up a Jellyfin receiver for your TV, phones, computers and other devices in a future tutorial. 

SunFounder



Pironman 5

The Ultimate NVMe-Enhanced Mini PC Case for Raspberry Pi 5

- PCIe Gen2 x1 NVMe PIP
- Support M.2 KEY-M NVMe SSD 2230 to 2280 sizes
- Tower Cooler + Dual RGB Fans
- 270° Full View Mini PC Case
- Standard HDMI x2

15% Off for MagPi Readers
Use Code: [Magpi15%off](#)

Order Here: sunfounder.com

DESIGNED FOR  Raspberry Pi **5**

Amplify Your Ideas.



Argon ONE
V5



Argon
NEO 5 NVMe



Argon
Poly+5

Argon
FORTY

sales@argon40.com

www.argon40.com

Build a private cloud server: Collaborate!

Take control of the cloud with your own collaboration and office suite hosted on Raspberry Pi



MAKER
PJ
Evans

PJ is a writer, software engineer and homelab enthusiast. He likes to stop, collaborate, and listen (you might have to ask your parents).

mastodon.social/@mrpjeans

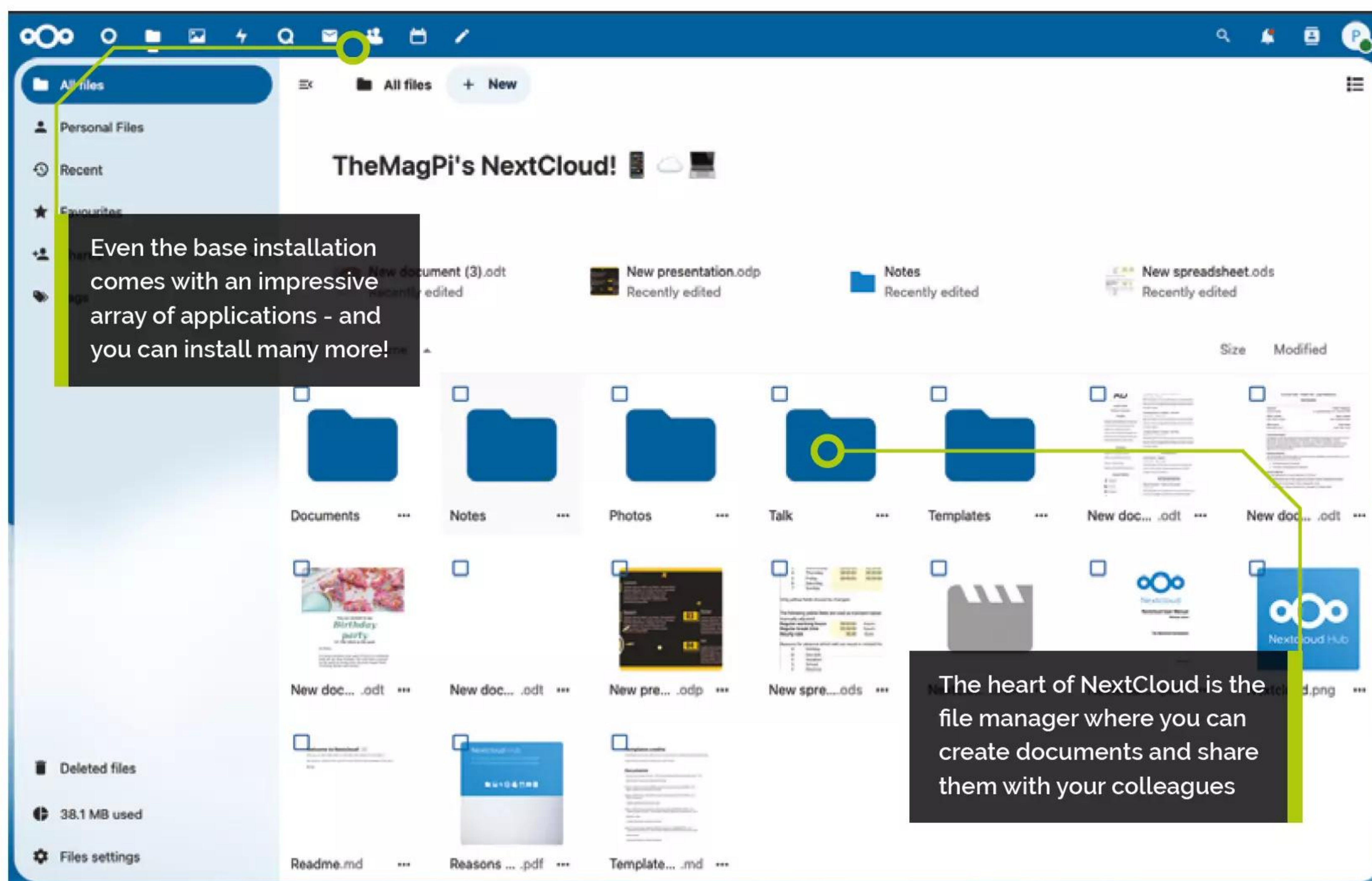

You'll Need

- Private cloud server
magpi.cc/144
magpi.cc/145
magpi.cc/146
- Domain name
- Static IP (or DuckDNS setup)

One of the great things about cloud services is the ability to collaborate with people all over the world. You can share documents and work on them together. You can have shared calendars, contact lists, and more. It was once true that this kind of power meant sharing your data with large companies. Now, open source tools mean you can have your very own groupware running on your device that can be accessed from anywhere. Now we have our

cloud server up and running, it's time to unleash its true potential.

01 Introducing NextCloud

If we need all the common tools for group collaboration then we're talking calendars, contacts, notes, email and maybe chat. And that's for starters. What about being able to

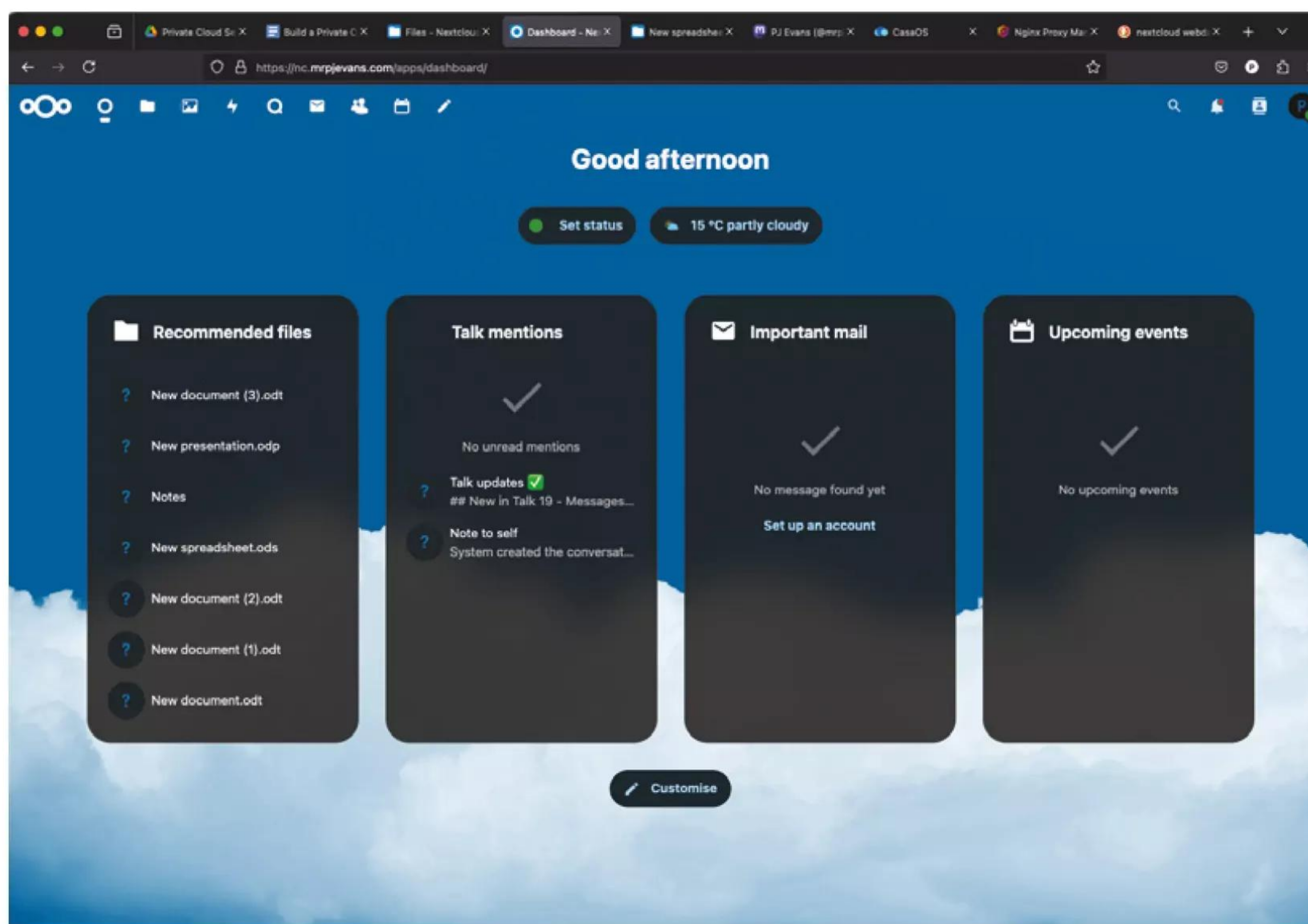

◀ This friendly dashboard is the first thing you see upon logging in and provides a useful summary of activity

“ We’re talking calendars, contacts, notes, email and maybe chat ”

view and edit documents or spreadsheets? You would think doing this would require installing many, many packages and trying to get them all talking together. Thankfully, the good people of NextCloud have created a fully integrated suite of products that make running a collaboration system easier than ever before. We’re going to install a simple version of the NextCloud suite and make sure it can be accessed from anywhere.

02 Installation

In the previous part of this series we installed CasaOS, a control system and dashboard for installing server-side apps. Again, CasaOS will take the pain out of installing NextCloud. Log into CasaOS on your server (if you followed the instructions it’s on port 82) and select the App Store. Search for NextCloud and click

to install. It’s that simple. Give it a couple of minutes, maybe a bit more if you’re on a slower connection, and you should be returned to the CasaOS dashboard with a shiny new NextCloud icon. Best thing to do now is click it!

03 Set up the admin account

Upon clicking on NextCloud you will be taken to a new browser tab on port 10081. This is NextCloud’s entry point locally, although we’ll make that easier later. For now, the most important thing to do is set up the first account, which will double as the administration account for the whole system. If this is for an organisation, you may want to consider a dedicated admin account, although you can promote and demote accounts later on. Also, remember to choose a decent password, the longer the better. Now you’ll be taken through a brief introduction and then to your dashboard.

04 Create the domain

NextCloud is very particular about the domain name and security. Therefore we

Top Tip

Mail matters

Running your own email server is not for the faint-hearted. If you really want to, we recommend reading ‘Run Your Own Email Server’ by Michael W Lucas: magpi.cc/emailserver

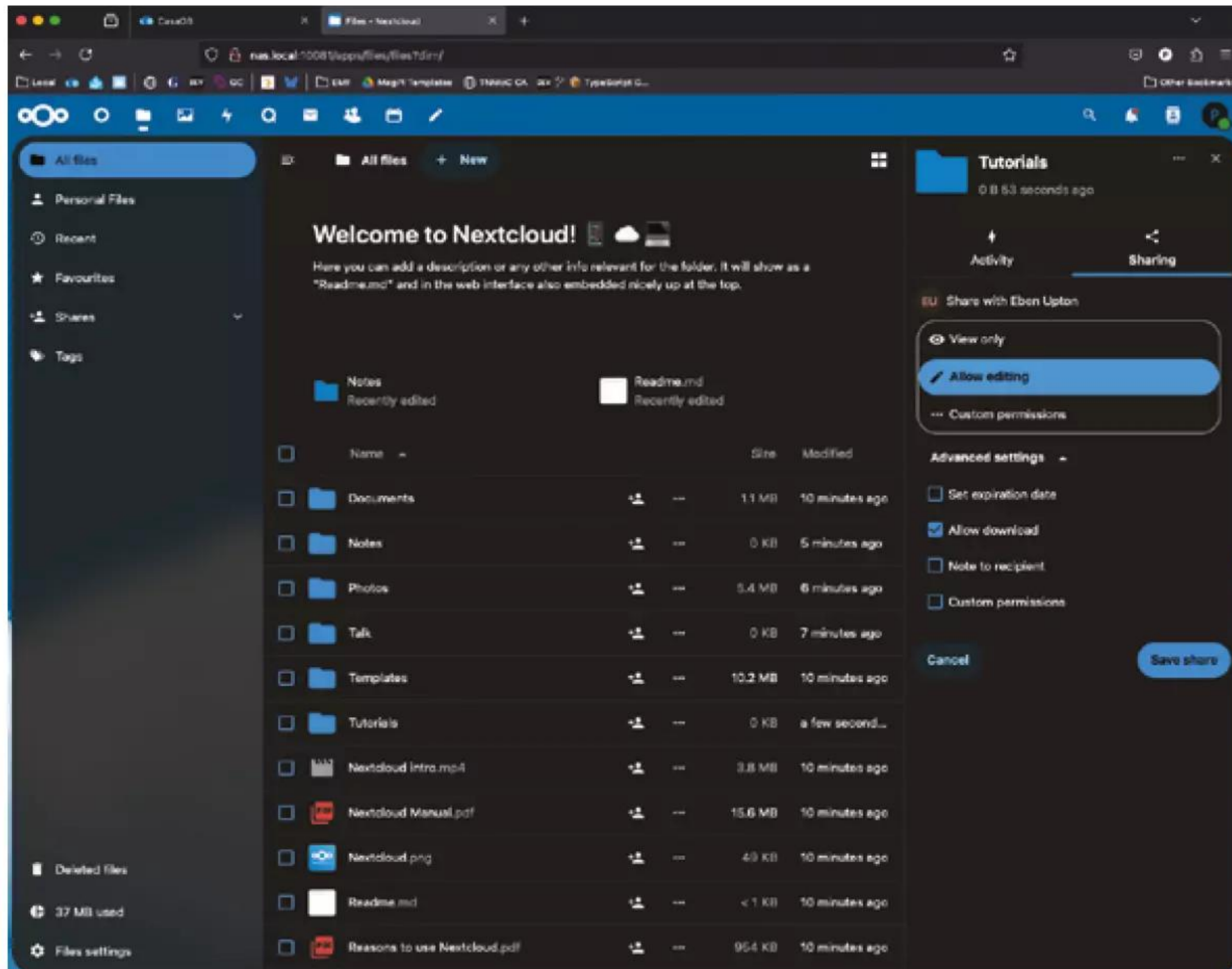

▲ Sharing a file or folder with another user takes just a couple of clicks. You can also set various permissions and expiry dates

recommend using a real external domain name. If you followed the previous tutorial ([magpi.cc/146](#)) you will already have one for file sharing. In this case, you need an additional one that is either pointing to your static IP address or dynamic DNS service provider. We'll use 'nc.themagpi.com' as an example. If you haven't already, configure your router to forward ports 80 and 443 to your server. See *The MagPi* issue #146 ([magpi.cc/146](#)) for the full guide. Any requests coming to your new domain name will now be sent to your private cloud server.

05 Configure Nginx

Last time we installed Nginx to act as a proxy between the outside world and your server. This also allows the traffic to be encrypted using SSL. We're now going to use another trick up Nginx's sleeve which is domain proxying. From CasaOS, click on Nginx Proxy Manager, log in and click on 'Proxy Hosts'. Now enter your new domain name, leave 'http' unchanged and add the IP of your private cloud server under 'Forward Hostname'. Enter 10081 for the port. Now click on the 'SSL' tab and select 'Get a new certificate from Let's Encrypt'. Click ok to configure everything. You should now be able to access NextCloud from your new domain name using HTTPS.

06 Add trusted host

Well, you can access NextCloud but you'll probably see an error about now being a trusted host. Again, NextCloud is trying to keep things as secure as possible and you've arrived on a domain name it doesn't know about. To fix this we need to add your new domain as a trusted domain. Unfortunately, this requires a bit of command-line work. SSH into your server and run these commands:

```
cd /DATA/AppData/nextcloud/var/www/html/
config
sudo nano config.php
```

Carefully amend the `trusted_domains` array so you add the line starting '1':

```
'trusted_domains' =>
array (
    0 => 'nas.local:10081',
    1 => 'nc.themagpi.com'
),
```

CTRL+X, followed by Y, to save and leave Nano. The changes take effect immediately.

07 Take the tour

That's all the hard work over with. If all is well, the error message will have disappeared and you can log in to NextCloud. If you find the server is no longer working, return the file you edited in the previous step and check everything is exactly right. One character out of place may break everything. Hopefully, you're now in and can have a look around. You'll see a useful dashboard that will summarise what's been going on (probably not a lot to begin with) and a range of apps across the top that perform all manner of useful functions. To the top-right you are able to access both your account and the server settings.

08 Meet the apps

Out of the box, NextCloud has a range of useful features so do spend some time exploring them. It has its own dedicated file storage and sharing app which kind of acts as a central hub. You have a personal folder and can share

folders with others by creating new users in Administration and granting them permissions. You also have access to calendars, contacts, chat, notes and email. You can create multiple instances of these and share them. Try creating a second user and setting up shared file space, calendars and contact lists. NextCloud doesn't come with an email server but can act as a client and use it to integrate with the other features.

09 Add new apps

Did we mention the app store? By no means have you reached the limits of NextCloud's potential. NextCloud provides a community app store with literally hundreds of enhancements for your cloud server. Some are simple integrations to make it easier to work with other products and others are business-class apps in themselves such as charting, mind mapping and technical drawing. Best of all, these

are all just a click away with no fuss installation. Have a browse around and see how you could enhance your server! To access, just click Apps under your account menu on the top-right.

10 Enabling office features

We've got all the collaboration and communication good stuff ready to go, but what about creating documents? Out-of-the-box NextCloud can edit simple text files but what if you need more? NextCloud uses Collabora CODE as a back-end for office apps. A simple version is available built-in but needs a couple of steps to enable. Under Apps, click on 'Office & text' then look for Collabora Online (ARM64) and install it. Then go to 'Administration' then 'Built-in CODE Server'. You can now enable it. Go back to the files app and click 'New'. You'll be able to create documents, spreadsheets, presentations and more.

Bundle Name	Version	Status	Action
Enterprise bundle Download and enable all			
Auditing / Logging	1.19.0	✓ Featured	Download and enable
File access control	1.19.1	✓ Featured	Download and enable
Files automated tagging	1.19.0	✓ Featured	Download and enable
LDAP user and group backend	1.20.0	✓ Featured	Download and enable
Retention	1.18.0	✓ Featured	Download and enable
SSO & SAML authentication	6.3.0	✓ Featured	Download and enable
Terms of service	2.5.0		Download and enable
Hub bundle Download and enable all			
Calendar	4.7.16	✓ Featured	Download and enable
Collabora Online - Built-in CODE Server (ARM64)	24.4.802		Download and enable
Contacts	6.0.0	✓ Featured	Download and enable
Mail	3.7.9	✓ Featured	Download and enable
Nextcloud Office	8.4.8	✓ Featured	Download and enable
Talk	19.0.10	✓ Featured	Download and enable

◀ Without even having to leave NextCloud, you can install hundreds of apps in just a single click

Top Tip



Memory matters

NextCloud needs a lot of memory to run, even more with Collabora. A Raspberry Pi with 8 GB of RAM is a must.

11 Connecting

NextCloud doesn't just restrict you to the web interface. It also has a range of services available so you can use your favourite client apps if you wish. Files can be accessed directly using the common WebDAV protocol (which is built-in to many operating systems). A free background sync app is also available for download. Calendars and contact lists can be accessed over the CalDAV and CardDAV protocols which many apps support. For mobile access, you can use the dedicated NextCloud app for the full experience. With your setup you'll be able to access everything from anywhere in the world from a phone, laptop, or computer.

12 Going to the next level

Congratulations, you have an amazing system for collaboration that you own, and therefore your data is private. However, there

are a few things we should warn you about before carrying on. NextCloud is a well-developed product, but all software of this size has bugs and there are occasionally security

“ For mobile access, you can use the dedicated NextCloud app for the full experience ”

risks. Make sure NextCloud is kept up-to-date (via CasaOS) and consider using VPN (magpi.cc/vpn) for access if you're unsure. Also, if you're considering a lot of usage, read up on implementing a more capable database and a dedicated Collabora instance. More than anything, make sure you back everything up! Now the serious business is done, next time we'll be getting a bit more social. ”

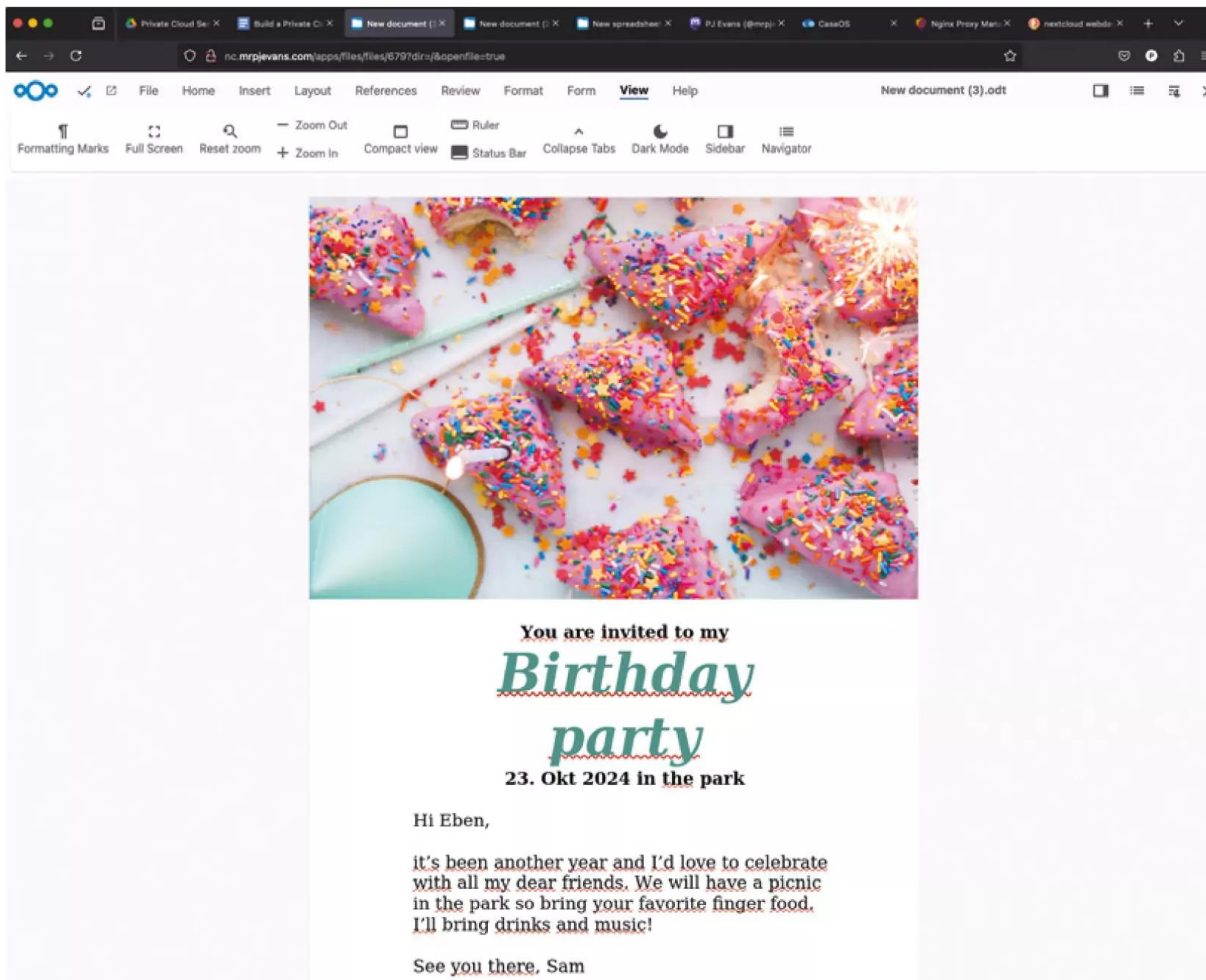

► After a little configuration NextCloud becomes a suite of office apps including word processing, spreadsheets and presentations

Your FREE guide to making a smart TV

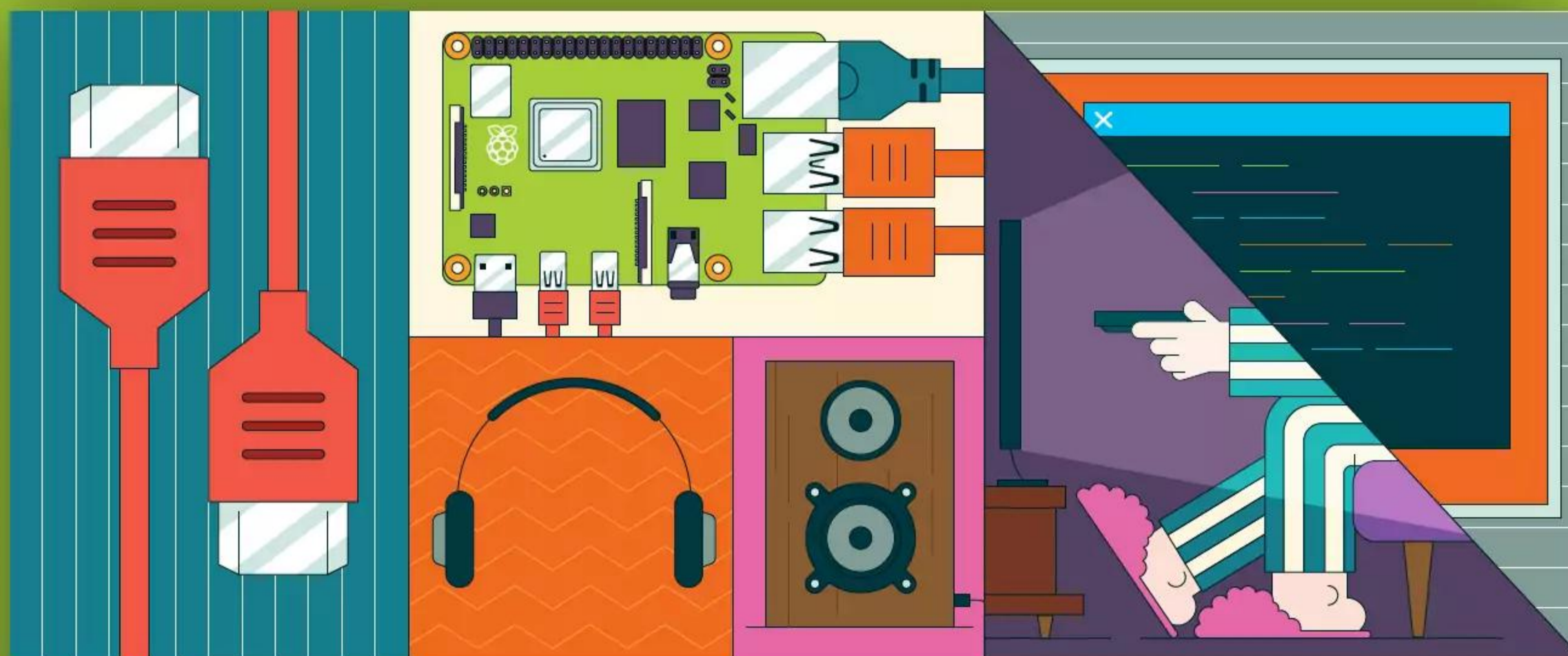

BUILD A RASPBERRY PI MEDIA PLAYER

Power up your TV and music system



FROM THE MAKERS OF *MagPi* THE OFFICIAL RASPBERRY PI MAGAZINE

magpi.cc/mediaplayer

HackSpace

TECHNOLOGY IN YOUR HANDS

HACK | MAKE | BUILD | CREATE

TOP PROJECTS

PG
66

BLUETOOTH RETRO PHONE

Video chat with friends and colleagues like it's 1955



PG
68

GIMBAL CLOCK

3D printed numbers turn and twist to tell the time

PG
70

PELICAN CYBERDECK

Merge form and function with some clever 3D printing



PG
72

OUIJA ROBOT

A creepy way to get messages from social media

PG
74

ROTATING MUSEUM

Bring the world's treasures to your 3D printer

OBJET 3D'ART

PG
76

ROBOT HAND

3D print an extra set of fingers



FORGE

PG
80

SOFTWARE DEFINED RADIO

Pick up radio waves on a Raspberry Pi Pico



PG
84

PYTHON-ISH

Write your own programming language

PG
88

STRING ART

A fine way to make pictures



PG 94

RP2350 BOARDS

The best products rocking
the new RP2350 chip

Best of Breed

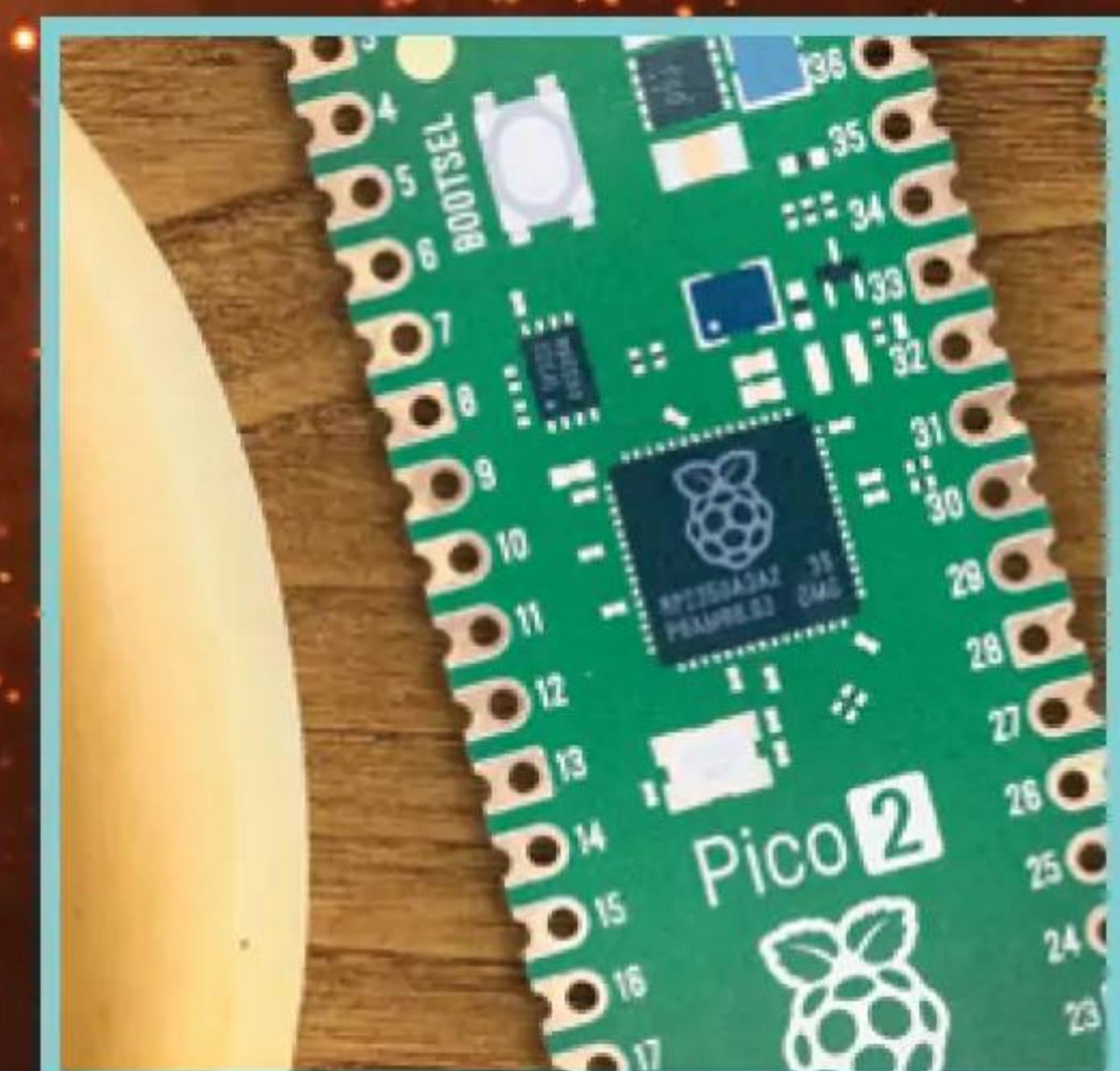
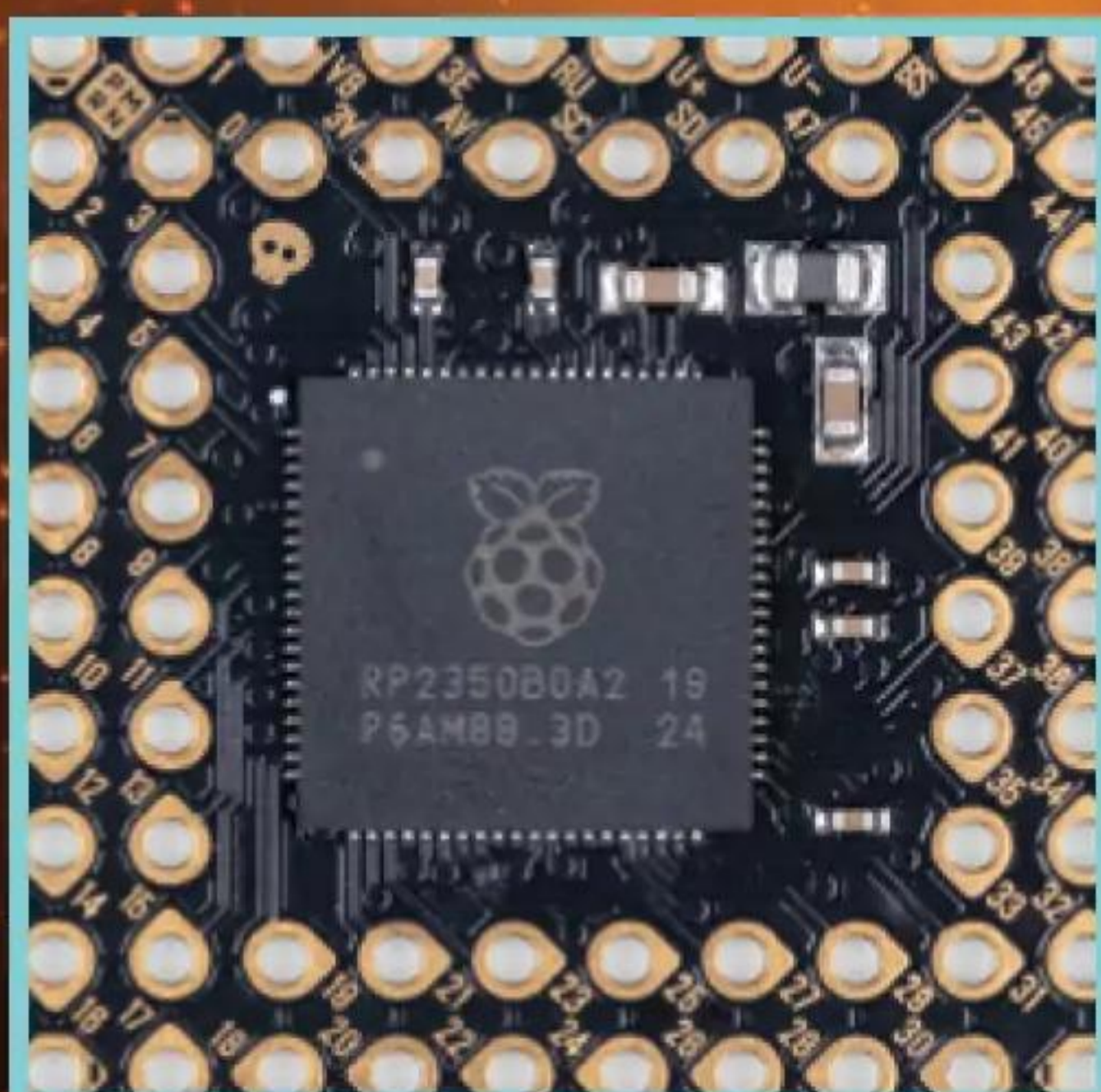
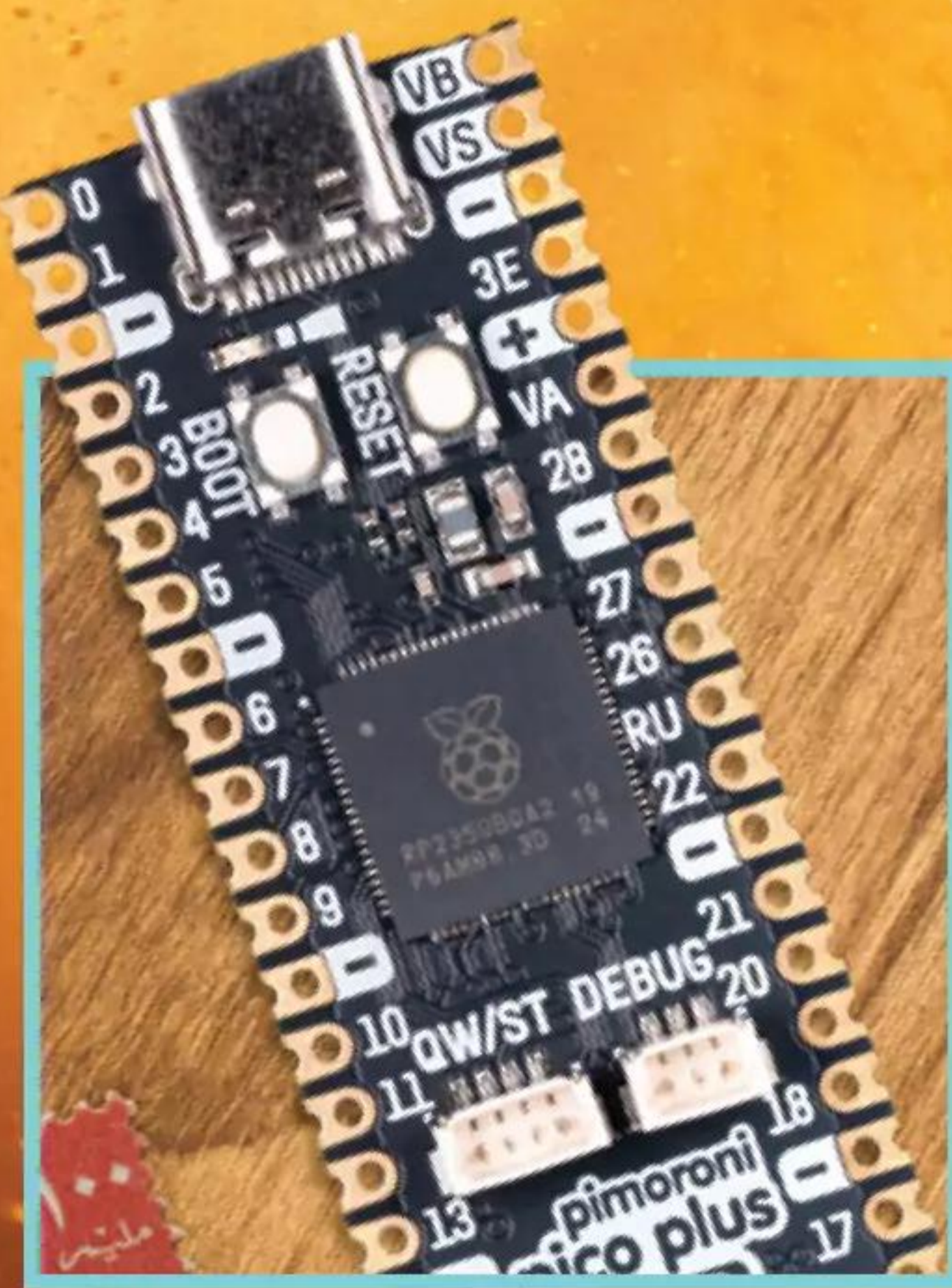

Bluetooth bakelite phone headset

By Jouke Waleson

hsmag.cc/BakeliteBluetooth

This Bluetooth headset is built into the body of a Dutch phone from 1950, simply called a 'type 1950'. It's powered by an ESP32 development board, and it works well enough that its creator, Jouke Waleson, can use it in a professional setting.

Lifting the horn picks up a call; putting it down disconnects the call. If there's no incoming call when you pick it up the phone connect to Siri. There's a 1500mAh battery that lasts for about a day; that's not huge for something like this, but there is a USB-C charging port, and the nature of this device means that it stays on your desk.

What else? The rotary dial works for calling phone numbers, and there are buttons to connect/disconnect to Bluetooth on the creator's phone, and his laptop, for when you need to inject some 1950s flavour into your video chats. ▣

Right ▣
Jouke bought this handset for about €10 in a second hand shop a few years back. There's so much retro hardware out there begging to be upgraded!





Gimbal clock

By Mosivers

hsmag.cc/GimbalClock

We've seen the brilliant creations of physicist, electronics enthusiast and maker Mosivers before, but never anything as intriguing as this clock, which plays with motion and perspective to display the time on a constantly moving set of 3D-printed rotating

characters. These characters use the dual letter illusion, which is an effect created by extruding different numbers from a solid block after rotation. It's simple, and it's clever, which makes it a perfect basis for an unusual clock.

The project uses an ESP8266 development board, 13 MG90 servos and a PCA9685 PWM driver board; everything else in this build is 3D-printed.

Of the four digits the clock displays, the simplest is the first one, which needs to be either a 0, a 1 or a 2 to display every time from 00:00 to 23:59. When looked at from one angle it shows a 0; rotate it and it shows a 1; rotate it again and it shows a 2. The other digits are more complicated, so Mosivers has got round this by adding more than one rotating number to each column; it's an imperfect solution, but it works (as long as you're looking at the clock from just the right angle). □

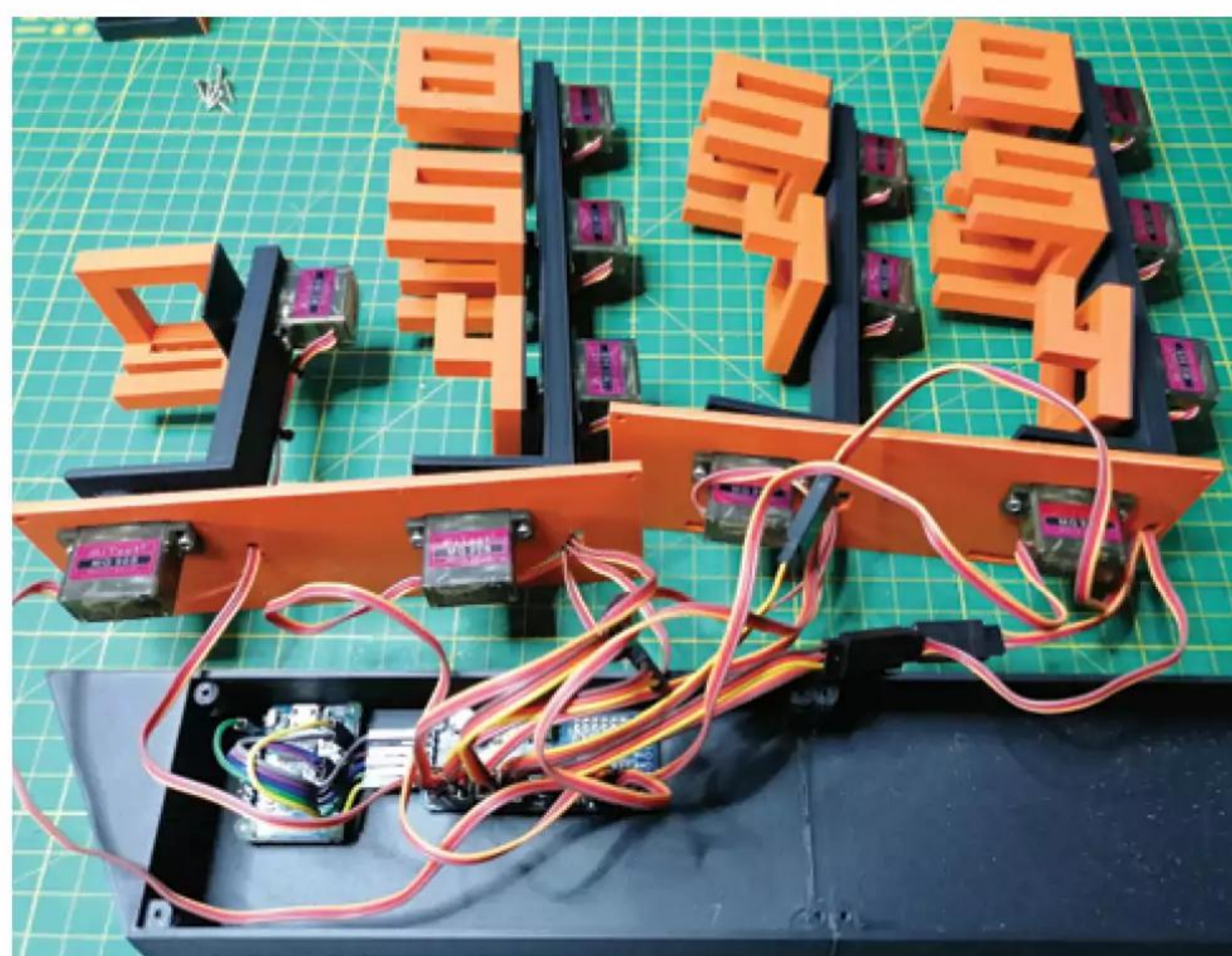

Right □
You'll need a reliable 3D printer if you want to try this at home





Pelican cyberdeck

By Jake Simek

hsmag.cc/PelicanCyberdeck

This 1150 case contains a Raspberry Pi 4 with 4GB RAM, and separate USB battery packs for the screen and the Raspberry Pi. There's inbuilt cooling in the shape of a 30mm fan and two 18mm fans, water-resistant ports for HDMI, USB-C, and Ethernet, as well as an SD card reader. All together, it's a nice build, and one that really fits the aesthetic of a cybersecurity professional working away on Kali Linux.

Of course, you can't just chuck a load of components together and hope that everything will fit. Jake has had to design and build some 3D-printed elements to hold everything in place, namely a screen holder and a base for the keyboard. **▣**

Right **▣**
Jake used ChatGPT to help with the electrical parts – just don't ask it how many Rs there are in strawberry





Ouija Robot

By Ronald McCollam

hsmag.cc/OuijaRobot

This spooky build reached our attention too late for Halloween, but there are always opportunities to contact the spirit realm. Or maybe just hook it up to ChatGPT and ask it for recipes. Either way, this Ouija Robot by Ronald McCollam is an unusual build, in that it uses both a Raspberry Pi and an Adafruit Crickit board. The reason for this is pretty standard: he had a Crickit to hand, wanted to do something with it, then later realised that it would be good to add the Raspberry Pi to provide a screen to display the messages displayed by the ouija board.

The Ouija Robot takes input from the social media platform formerly known as Twitter, and reads out messages via a robotic hand that moves a piece of plywood with a hole in it over a board (we now know that this smaller board is called a planchette, which sounds very much like French for 'little plank') with a laser-engraved alphabet.

Other hardware includes a servo for the arm and one for the planchette; two NeoPixels; and a 3.5-inch TFT screen to display the text of the messages received. ▣

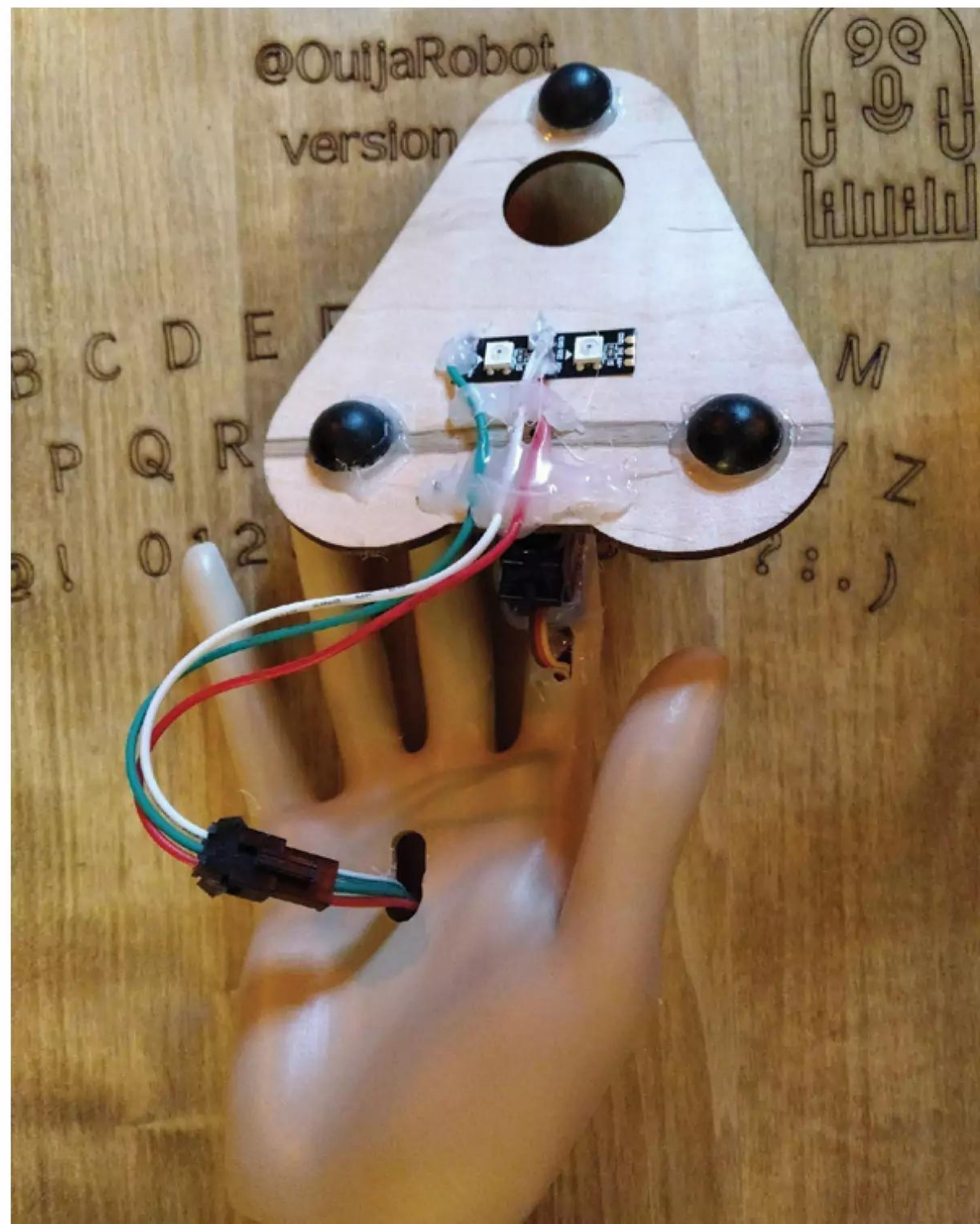

Right ▣
A pair of NeoPixels give a spooky flashing effect when a letter is chosen

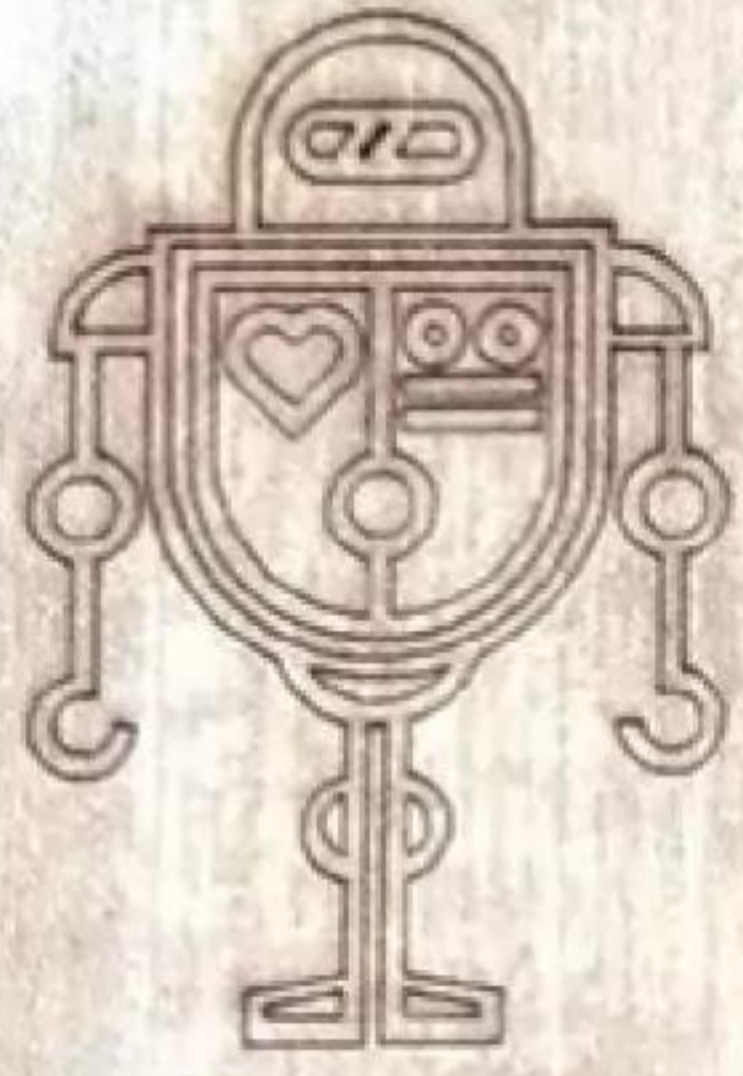

@OuijaRobot
version 1.0



A B C D E F G H I J K L M
R S T U V W X Y Z
1 2 3 4 5 6 7 8 9 ? : .)

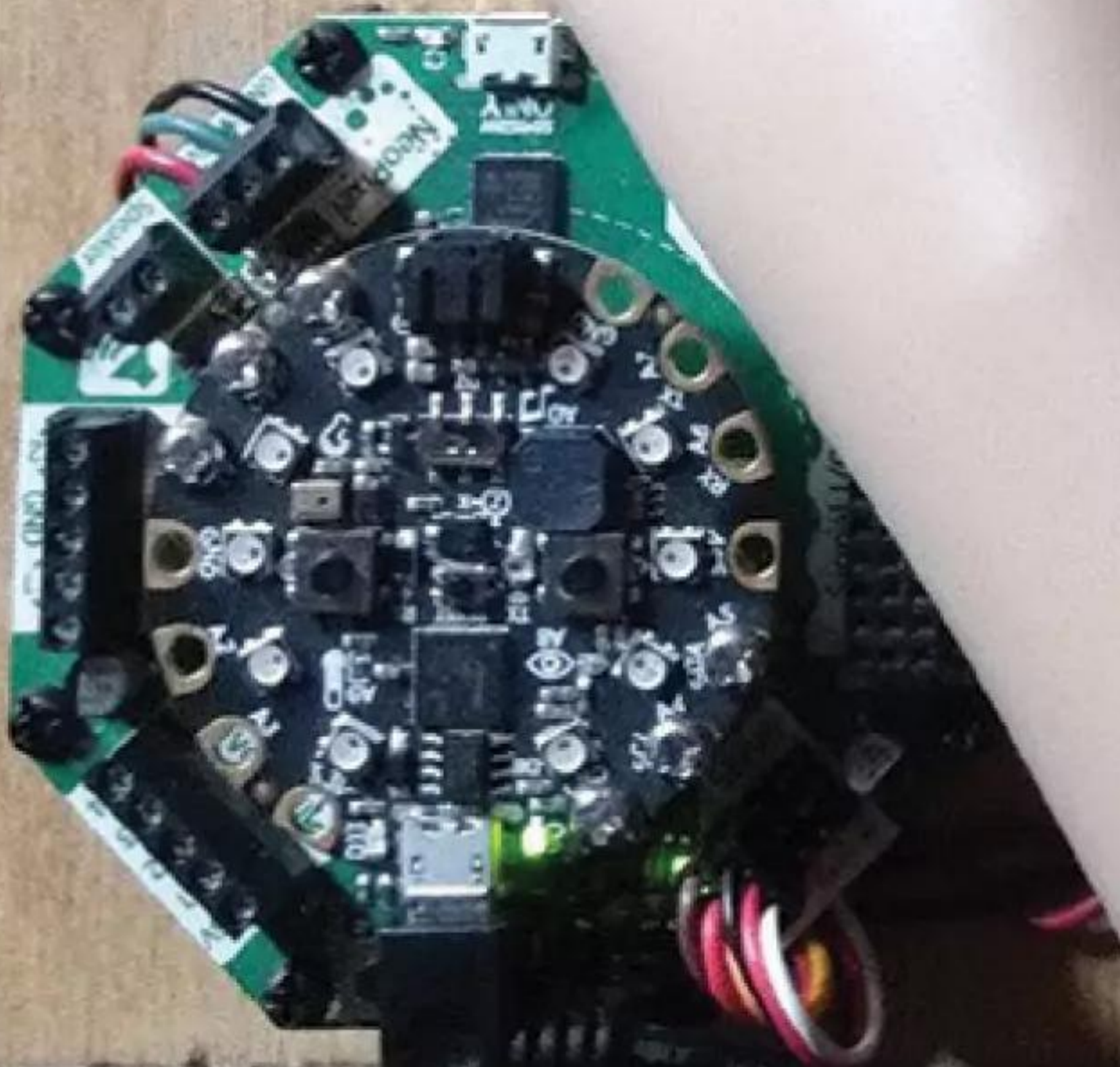

Rotating art museum

By Sanforlu

hsmag.cc/RotatingMuseum

As wonderful as our local art gallery is, it doesn't compare to the Museum of Fine Arts in Boston, MA, the Prado in Madrid, or any of the other major collections in Europe. But while we have a 3D printer, a laser cutter, and access to some free online resources, we can make our own version – at least, you can if you follow the example set by sanforlu in this superb rotating art museum. They've made 3D prints of four classical artworks and mounted them in a small rotating gallery, complete with a self-recorded audio description that plays at a touch of a button. "It's like having a museum curator right in front of you," according to its creator.

Rather than fly round the world with a scanner, the maker has used files from the Scan The World project, which is attempting to document the great artworks of humanity in .stl format (hsmag.cc/ScanTheWorld).

And rather than reinvent the wheel, they also used the free MakerCase tool – enter the dimensions of the enclosure you need, and MakerCase will produce a set of files that you can put into a laser cutter, or edit to add the cutouts you might need. For example, sanforlu made holes for the speaker, potentiometer (which controls the speed that the artworks rotate), on/off switch and the wires leading to the turntable (hsmag.cc/MakerCase).

This build is a brilliant synthesis of loads of freely available techniques and common maker tools. There's a Raspberry Pi Pico, an Adafruit potentiometer board and Adafruit microSD card reader, breakout board, speaker, breadboard and switch, while for the rotating part of the build there's a stepper motor, driver board and a bearing to make sure it rotates freely. What elevates this is the vision that put it all together. ▣

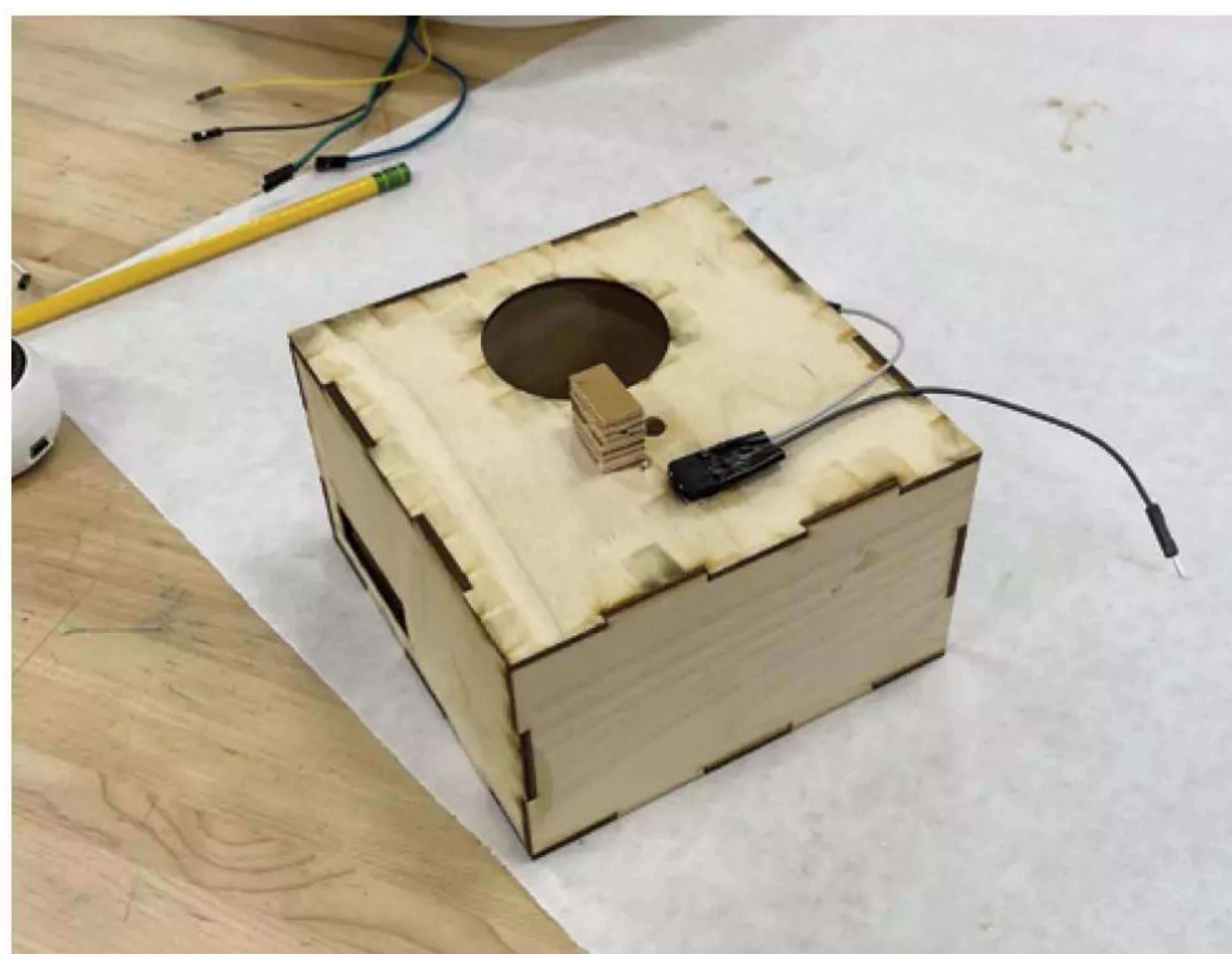

Right ▣

For these small, detailed prints, the maker used a .10mm layer size at 15% infill on a Prusa-XL



Objet 3d'art

3D-printed artwork to bring more beauty into your life

Many's the time we wished we had an extra hand. Whether it's carrying a round of drinks back from the bar, juggling keys, phone and baby all at the same time, or holding soldering iron, solder, a PCB and a through-hole component at once, a third hand would be useful. It's something that evolution really should have got round to by now, but somehow most of us are stuck with just the two.

You can buy little clamps to help with soldering tasks, but if you can 3D-print your own hand, complete with individually moving joints, why wouldn't you do that instead? This poseable robot right hand by Make-A-Print can move freely when assembled, and holds its position thanks to a locking mechanism in the joints.

Look closely, and you'll see how parts of each finger are clearly labelled on the print. The four parts of the index finger are A1, A2, A3; the next finger is comprised of B1, B2, B3 and so on. No, we haven't miscounted; the first of those parts is the knuckle joint, which is what enables the hand to flare out the fingers. The maker advises that anyone printing this makes sure that the supports are removed cleanly from each part, as not doing so will interfere with the fit and movement of the parts.

hsmag.cc/RobotHand





PROJECTS FOR MAKERS & HACKERS

BUILD A
FLAT-PACK
ROCKET

MAKE ELECTRONIC
MUSIC WITH A
RASPBERRY PI PICO

BOOK OF
MAKING
2025

MAKE A
CONNECTED
PLANT MONITOR

BUILD SMART
HOME LIGHTING

& LOTS
MORE

FROM THE MAKERS OF **HackSpace** MAGAZINE

BOOK OF MAKING 2025

Projects for Makers & Hackers

BOOK OF MAKING

2025

STEP INTO THE WORLD
OF MAKING!



- CONTROL THE WORLD AROUND YOU WITH A RASPBERRY PI PICO
- BUILD YOUR OWN CREATIONS USING OUR STEP-BY-STEP GUIDES
- DESIGN FOR 2D AND 3D FABRICATION METHODS AND MAKE THEM A REALITY
- FULL OF PROJECTS PERFECT FOR AN HOUR, AFTERNOON, OR WEEKEND OF MAKING

hsmag.cc/BookOfMaking2025



Build a Pico software-defined radio

Based around a Raspberry Pi Pico, this standalone SDR enables you to listen to a wide range of radio signals



Phil King

A long-time Raspberry Pi user and tinkerer, Phil is a freelance writer and editor with a focus on technology.

Take a look around you... no, you can't see them, but there are radio waves moving at the speed of light wherever you go. They're even being beamed well beyond our world, into outer space – maybe an alien civilisation

will pick them up one day?

Of course, you can use standard radio receiver hardware – analogue or digital – to turn some of those invisible broadcast signals into sound. A software-defined radio (or SDR for short) takes a different approach, using software to replace some of the radio hardware. Typically, you'd be running this on a PC, or at least sending audio to its sound card. Using a standard Raspberry Pi Pico microcontroller and some DIY electronic circuitry, however, Jon Dawson's Pi-Pico SDR project (hsmag.cc/PicoSDR) is a standalone device with its own audio output – although you can still hook it up to a PC if you want.

While Jon's original Pi Pico RX receiver project was based around a custom-designed PCB, this version can be built using (mostly) standard through-hole electronic components on a piece of protoboard or a solderless breadboard. Yes, equipped with just a Raspberry Pi Pico, an analogue switch (aka multiplexer/demultiplexer) and an op-amp, you can build an SDR receiver capable of listening in to signals with a frequency of up to 30MHz – in the long wave, medium wave, short wave, and amateur HT bands – from halfway around the globe. It'll also

run for hours on battery power. Intrigued by the possibilities, your author decided to have a go at building one.

In this first part of the guide, we'll build the main circuit and explain the basics of how it works. In the second part, we'll add an antenna and speakers/headphones and experiment to see what the Pico SDR can do.

SIGNALS TO SOUND

Details of how this SDR works can be found on Jon's blog page for the project. Signals from the antenna are boosted by the low noise amplifier (LNA) and sent to the analogue multiplexer. Together with the dual op amp and an arrangement of capacitors and resistors, this forms what is known as a Tayloe quadrature sampling detector (aka receiver or mixer), which converts high-frequency radio signals into lower-frequency IQ (in-phase and quadrature) signals that can be sampled using the analogue to

digital converter in Raspberry Pi Pico.

The Tayloe detector also helps to deal with the limited 250kHz bandwidth of Pico's ADC. For this, a local oscillator close to the desired listening frequency is generated by Pico's PIOs and sent to the multiplexer; with each oscillator cycle, this switches the incoming radio signals between four paths in quick succession. These samples are combined by the dual op amp to generate I and Q signals. These contain all the info needed for demodulation, including



With just a Raspberry Pi Pico, an analogue switch and an op-amp, you can build an SDR receiver



QUICK TIP

For the connecting wires, cut them to about the correct length, stripping the ends with a wire stripper. If using stranded (rather than solid-core) wire, you may want to tin the ends with some solder for a more reliable connection.

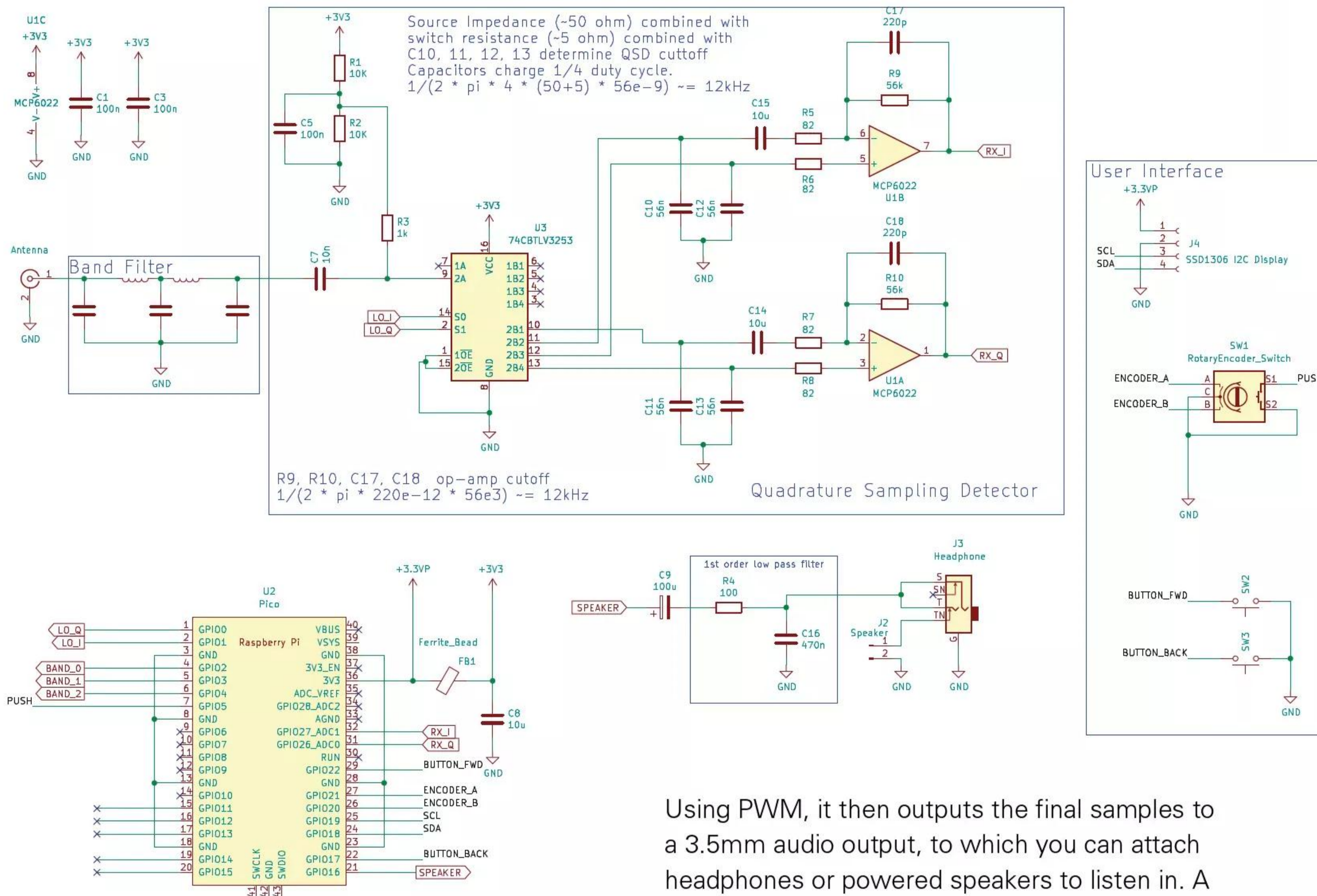

Figure 1 The schematic for the Pico SDR. Note that, unlike the wiring diagram, this includes a placeholder for an optional band pass filter between the antenna and multiplexer

YOU'LL NEED

- ◆ Raspberry Pico / Pico W / Pico 2
- ◆ PCB protoboard or solderless breadboard
- ◆ 100µH inductor / ferrite bead
- ◆ MCP6022 dual op amp
- ◆ 74CBTLV3253 4:2 analogue multiplexer
- ◆ Wire stripper/cutter tool and wires
- ◆ Capacitors: 2× 200pF, 1× 10nF, 4× 56nF, 3× 100nF, 1× 470nF, 3× 10µF, 1× 100µF
- ◆ Resistors: 4× 82Ω, 1× 100Ω, 1× 1kΩ, 2× 10kΩ, 2× 56kΩ
- ◆ 128×64 0.96-inch OLED
- ◆ 2× push-buttons (momentary)
- ◆ Rotary encoder
- ◆ 3.5mm stereo headphone jack
- ◆ Radio antenna, such as a YouLoop or similar
- ◆ Wideband LNA
- ◆ BNC (or SMA) female antenna connector

amplitude phase and frequency. Having both I and Q enables us to tell whether the signal frequency was higher or lower than the local oscillator and by how much. The dual op amp also subtracts one signal from another and amplifies the result by around 800. The capacitor in the feedback loop works as a low pass filter, removing signals above 12kHz.

Running Jon's custom firmware, Raspberry Pi Pico does some clever stuff such as oversampling the signals to remove unwanted alias signals.

Using PWM, it then outputs the final samples to a 3.5mm audio output, to which you can attach headphones or powered speakers to listen in. A rotary encoder and buttons are used to select the desired radio frequency, with the interface info displayed on an OLED screen.

SOURCING THE PARTS

The main electronic components required for the build are standard through-hole fare (with one exception that we'll come to) and most are fairly easy to find from the usual online retailers at little cost. After delving around in the bits box and discovering that his existing capacitor and resistor selections didn't contain all the values needed – including the

smaller capacitors – your author bought a couple more component kits on Amazon. Even then, the 56nF (563) capacitors needed for the Tayloe detector were not present, so these had to be sourced separately

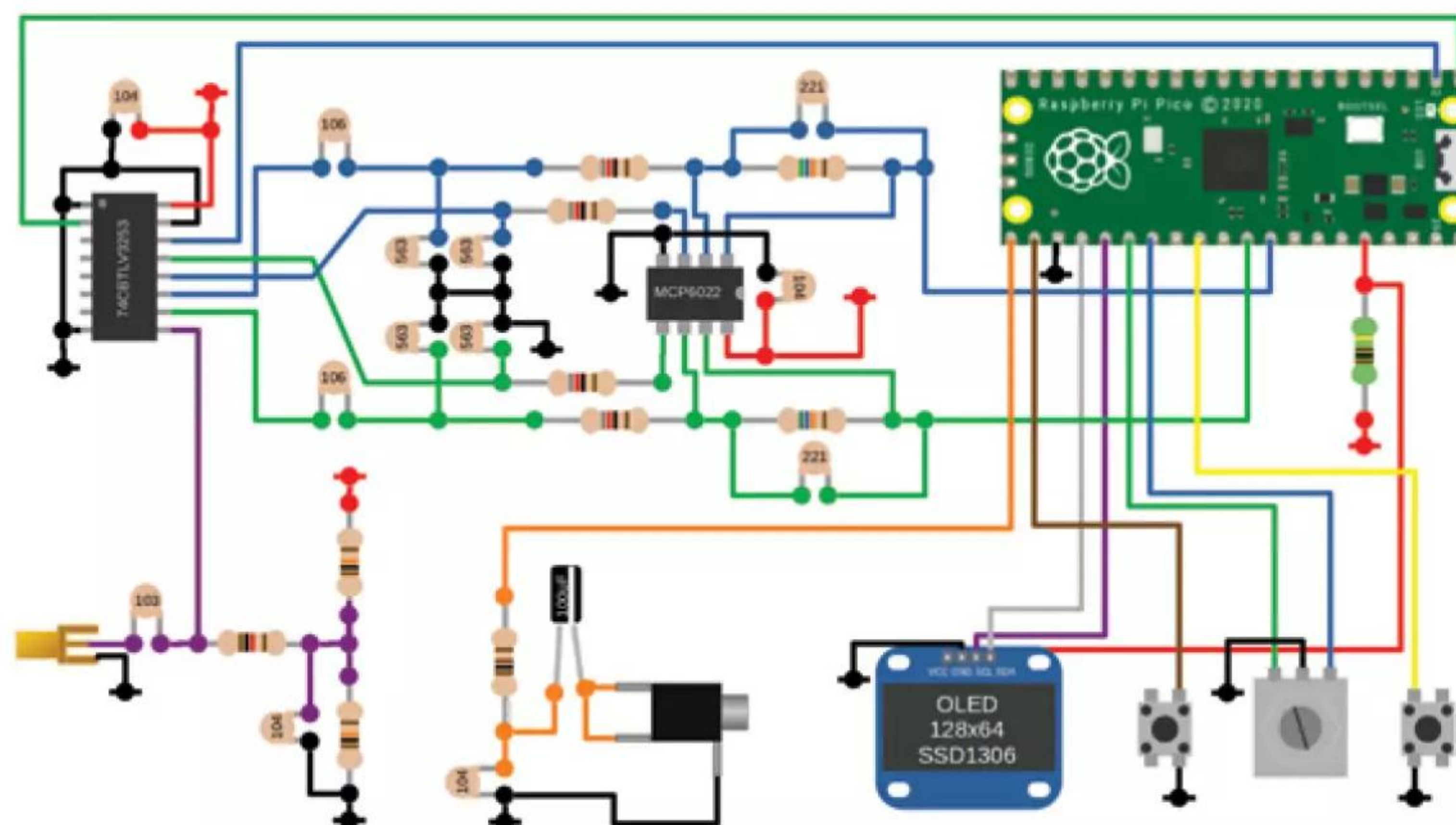

Left The wiring diagram for the SDR. Pico's 3V3 pin powers the main circuit via a 100µH inductor to help handle any current fluctuations

QUICK TIP

Confused by ceramic capacitor codes? You can discover the values they represent with this handy calculator at [Circuit Digest: hsmag.cc/CapCalculator](http://CircuitDigest.hsmag.cc/CapCalculator).

Right

The wiring diagram for the SDR. Pico's 3V3 pin powers the main circuit via a 100µH inductor to help handle any current fluctuations

Below

A hands-free magnifier is very useful for getting a close-up view for the surface-mount soldering of the multiplexer IC to a through-hole adapter

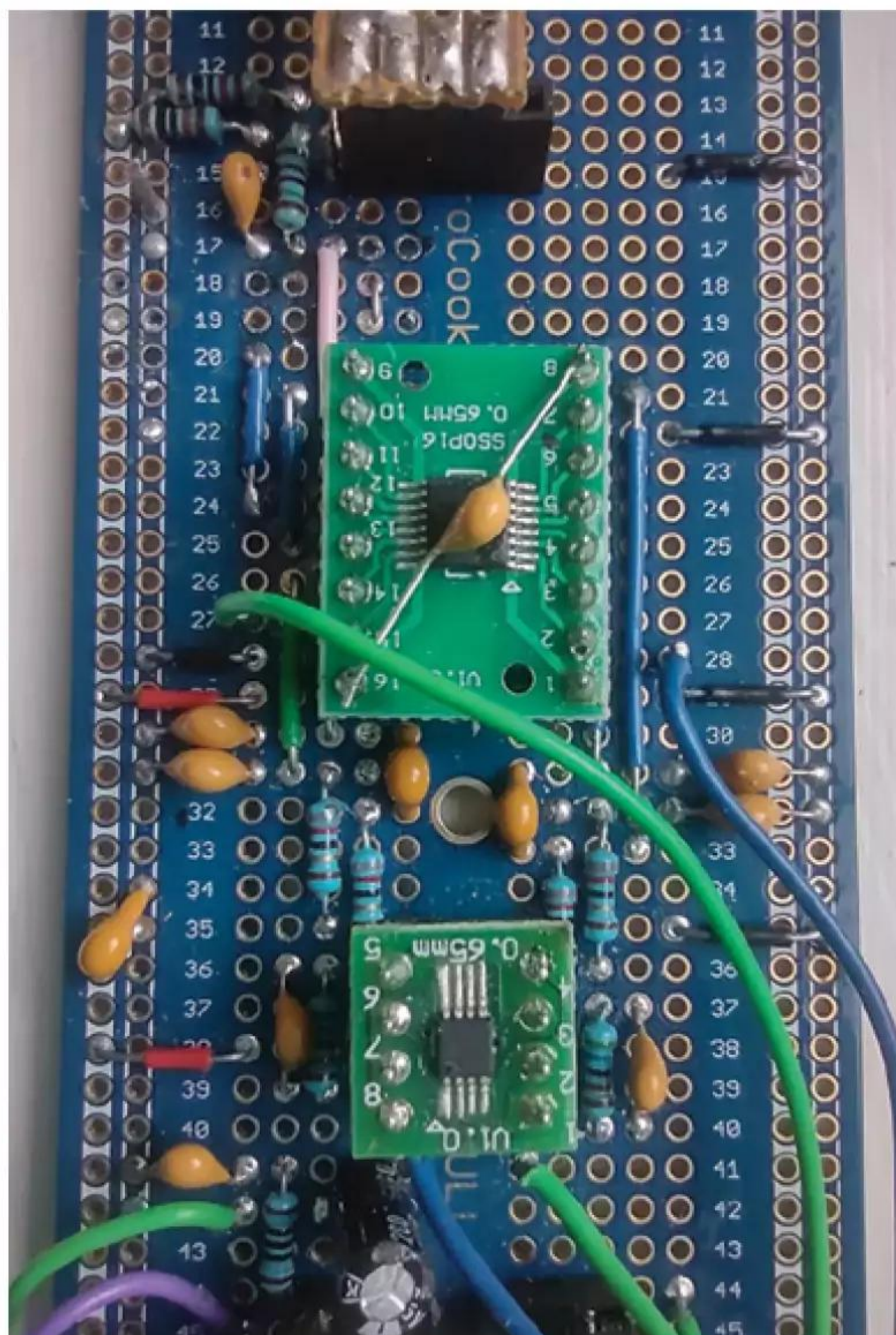

Below

Here, the main circuit is shown without the ICs present, enabling us to see more clearly the wiring and components around them

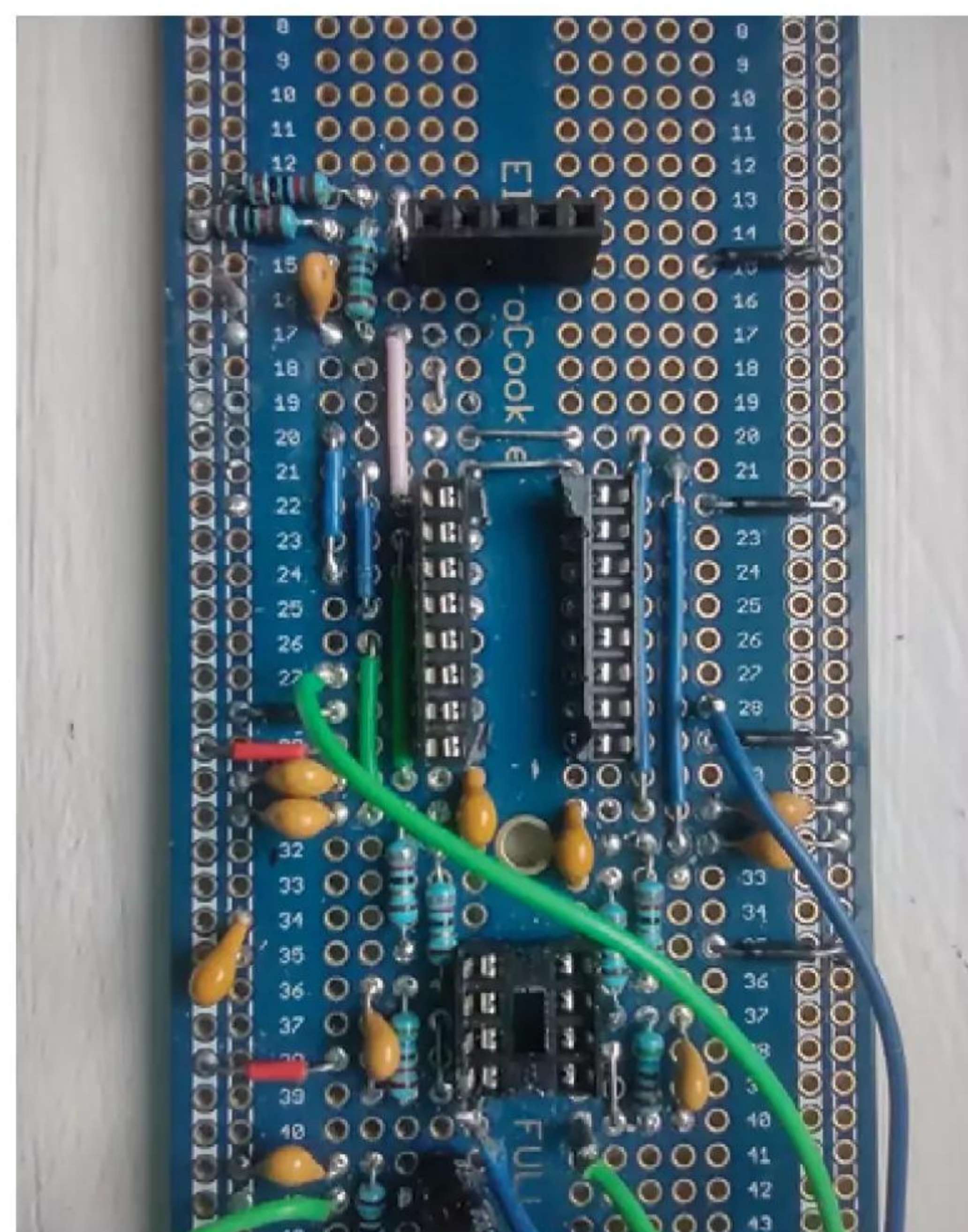

The soldering process for assembling the circuit on a protoboard is fairly simple

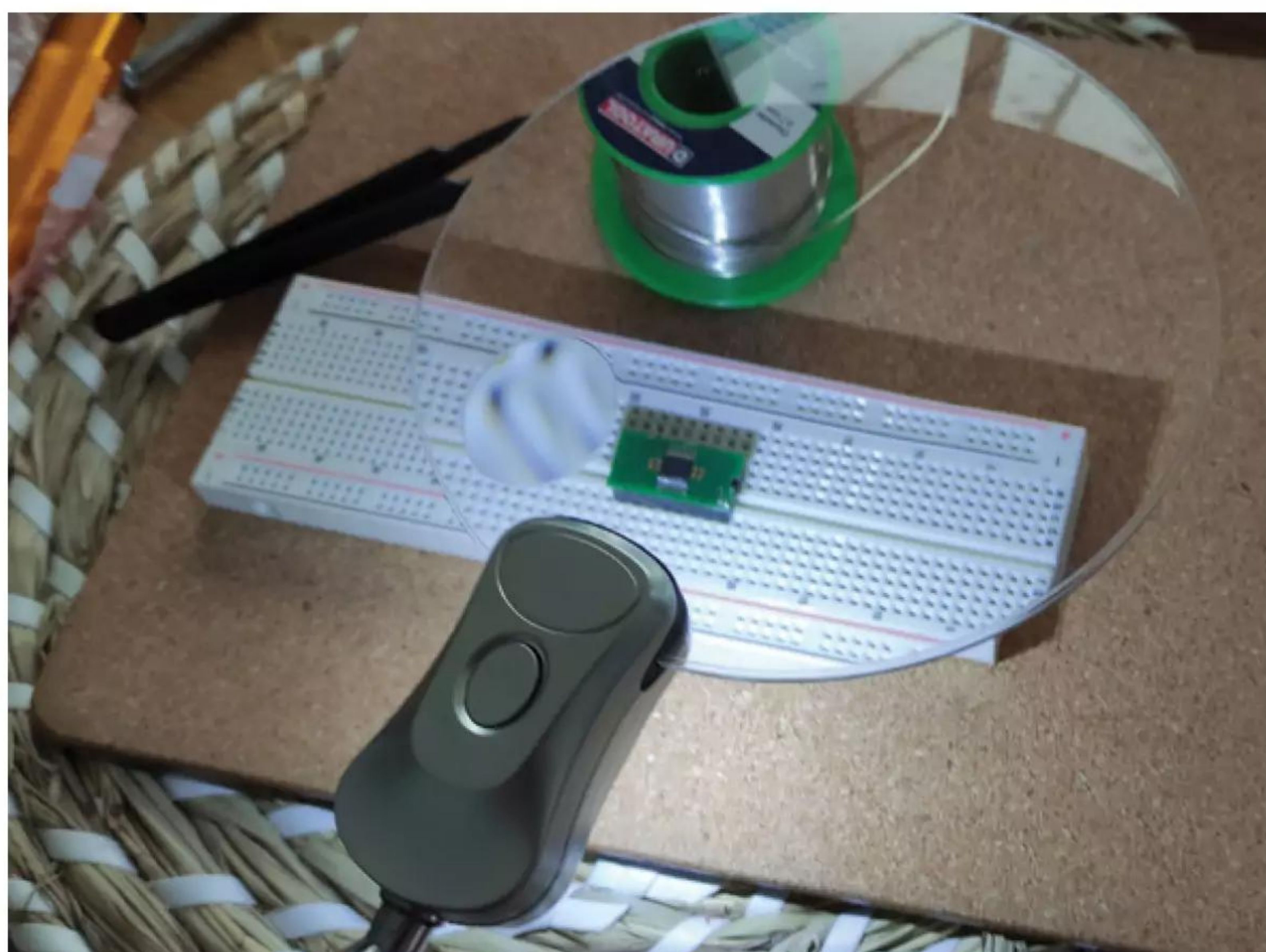

on eBay – they're of the polyester film variety, but that shouldn't matter. Similarly, any of the ceramic capacitors in Jon's build can be substituted with other types, including electrolytic ones for the higher values (but check the polarity is right for those).

Most of the other electronic components we ordered from DigiKey, but should be stocked by other specialist electronics suppliers. These included the two IC (integrated circuit) chips: the 74CBTLV3253 4:2 analogue multiplexer and MCP6022 dual op amp. Unfortunately, the multiplexer is only available in a surface-mount package (with 0.65mm pin pitch), so needs to be soldered to a suitable 16-pin SMD to DIP adapter (e.g hsmag.cc/SMDtoDIP) for breadboard use. This requires some fiddly surface-mount soldering, which we'll come to later.

For the display, any standard I2C OLED screen will work. We opted for a mini 0.96-inch one, as specified in Jon's design. The push-buttons and rotary encoder (not a potentiometer) for the controls can be sourced easily, along with the 3.5mm audio jack.

MAKING THE CIRCUIT

Helpfully, Jon has provided a wiring diagram and schematic on the project page, along with photos of the main circuit, reproduced here with his kind

permission. The combination of photos and schematic should enable you to recreate it on a prototyping breadboard. You could use a solderless breadboard to lay out the circuit and test it before going on to solder it on protoboard. You'll need to really check the connections are solid in each hole. You will still need to do some soldering to connect the surface-mount analogue multiplexer chip to a through-hole adapter – see the 'Surface-mount soldering' box below. We'd advise using protoboard for the final build.

If using a solderless breadboard, you can simply plug Raspberry Pi Pico and the two ICs (one with an adapter) into it. For protoboard, it's advisable to solder DIP sockets or female headers, into which you can plug the Pico and ICs, so you can swap them out later if needed.

Compared to the surface-mount soldering for the multiplexer, the soldering process for assembling the circuit on a protoboard is fairly simple. Just take your time and make sure the components are placed and connected correctly, referring to the photos and schematic (**Figure 1**). Note that the latter contains an optional band pass filter. Check you're using the correct value capacitors and resistors in each position. You can cut the leads to the required length after poking them through the holes and soldering.

The op amp and multiplexer through-hole adapter may have pin labels. If not, a small dimple on the top signifies pin 1, and the remaining pins are then numbered anticlockwise. You can also refer to the ICs' datasheets to double-check pin functions referred to in the schematic.

Jon's circuit layout includes a couple of female headers for an optional band pass filter, such as those available from QRP Labs at shop.qrp-labs.com/BPF. You can bypass this and the SDR will still work fine without it, although you may experience some interfering stations appearing where they shouldn't be.

Below

Built on a prototyping breadboard, Jon's circuit includes female headers to add an optional band pass filter

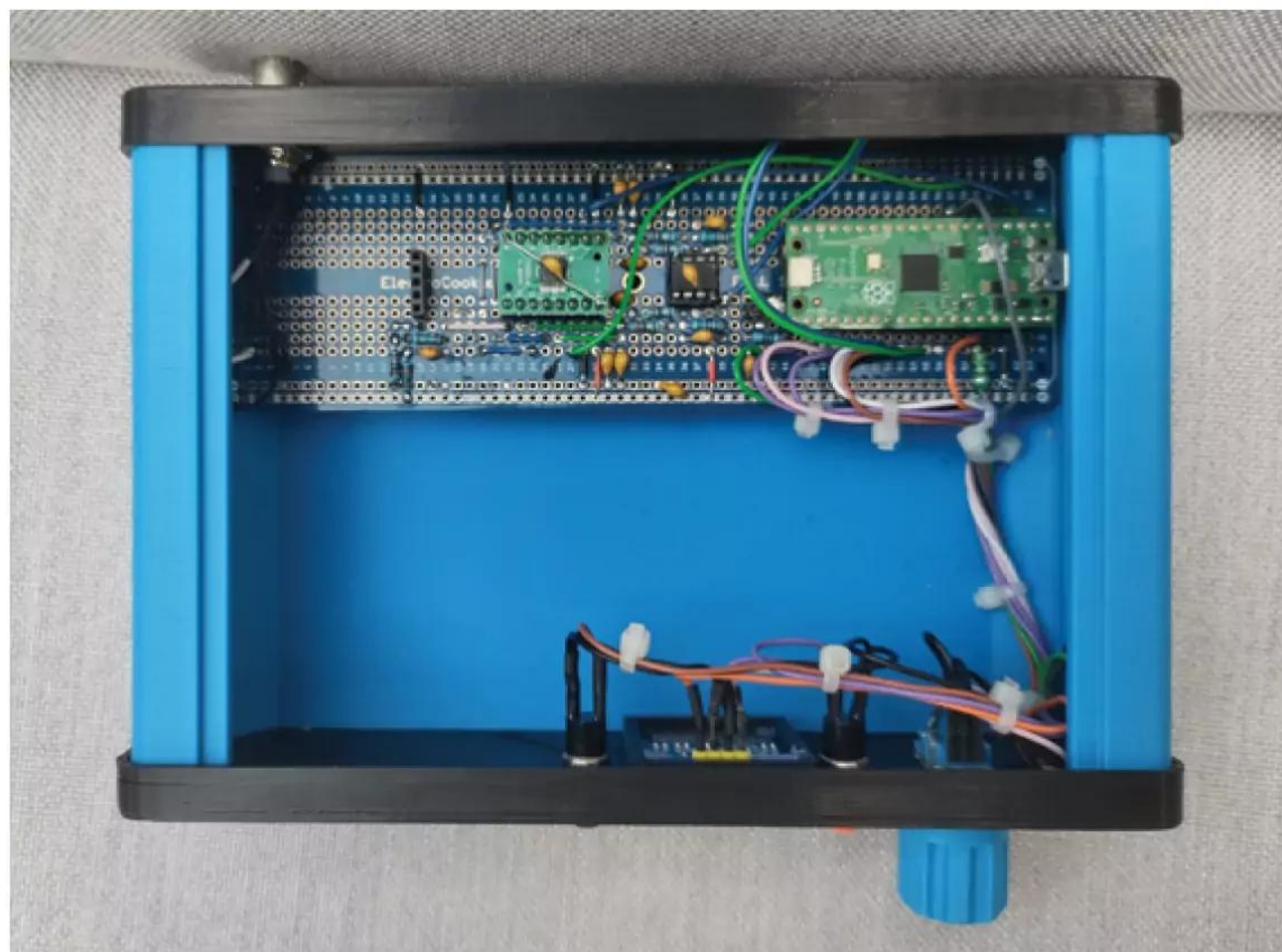
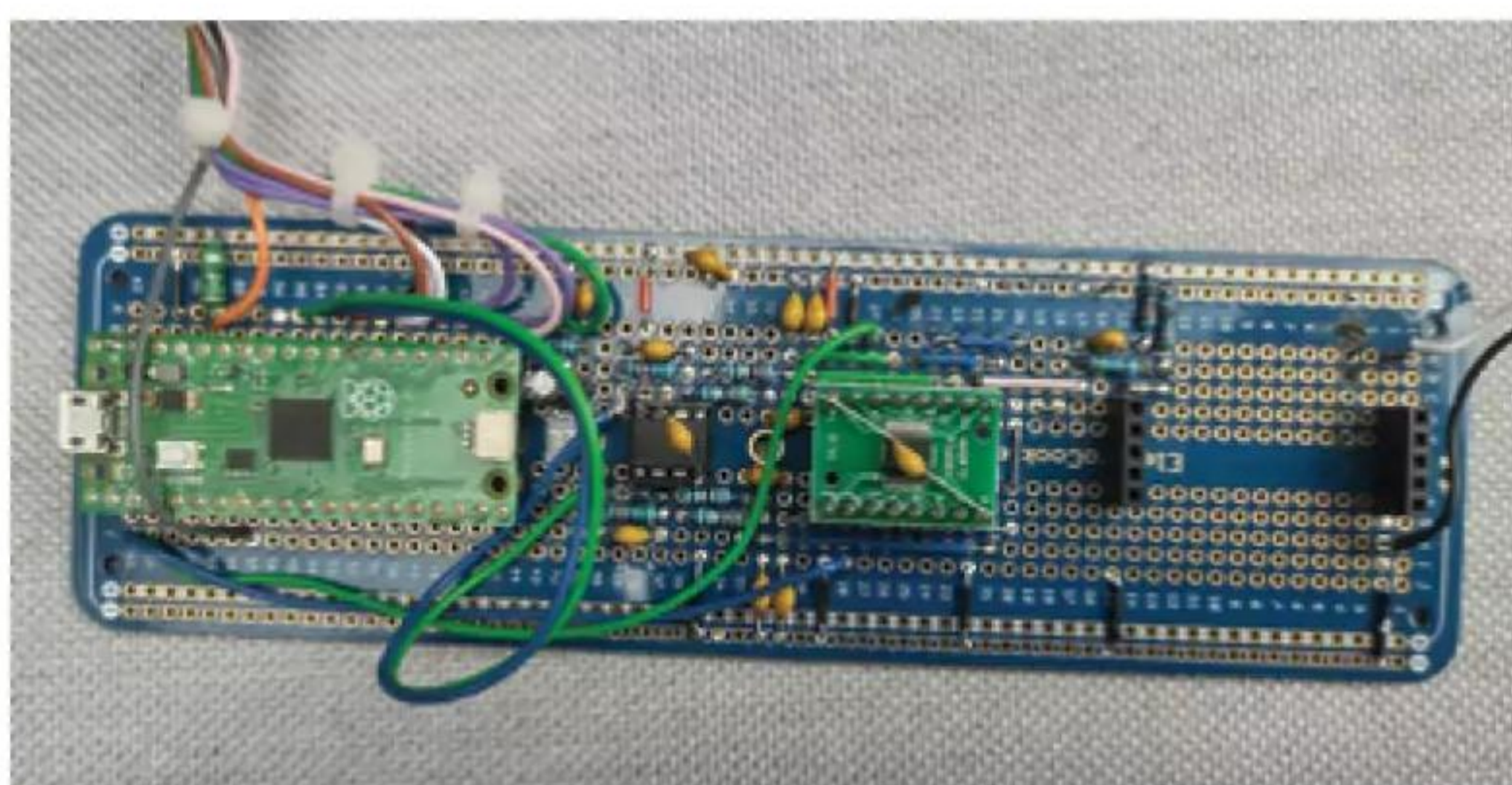

ARE YOU RECEIVING?

With the main circuit built, you will be ready to flash the custom firmware (from Jon's GitHub repo) to Pico and connect a suitable antenna, such as a YouLoop-style one, via a wideband LNA – powered by a 9V battery – to boost the signal. For more details on how to connect and position the antenna, use the interface for tuning, and what you can do with this low-cost SDR, stay tuned for next issue's second instalment! □

Above

The schematic for the Pico SDR. Note that, unlike the wiring diagram, this includes a placeholder for an optional band pass filter between the antenna and multiplexer

SURFACE-MOUNT SOLDERING

Since the 74CBTLV3253 4:2 analogue multiplexer is only available as a surface-mount package, you'll need to solder this to a through-hole adapter. Make sure the latter has a 0.65mm pitch for the pads on the top, to match that of the multiplexer pins. Naturally, the adapter's pins on the bottom should have a 2.54mm (0.1in) pitch to fit a standard breadboard.

Your author had never attempted surface-mount soldering before, so this was new territory. A hands-free magnifying glass with a light proved very helpful for getting a closer look at the tiny components. Branchus Creations' YouTube tutorial (hsmag.cc/SMDsolderYT) was also a great help.

To start, cover the adapter's pads generously with a tacky liquid solder flux. Following this, use anti-static tweezers to position the IC on top of them, making sure all the pins are aligned correctly with the pads.

With the soldering iron on a high heat (around 420°C), melt a blob of solder onto the tip. Then, holding the chip in position with the tweezers, solder one of the corner pins. Check again that the pins are well aligned, then solder the corner pin diagonally opposite.

With the chip secure and the pins aligned, you're ready for some drag soldering to connect the remaining pins. Holding the solder wire (preferably 0.5mm or thinner) in one hand and the iron in the other, move quickly along the pins to solder each one to its pad. If you get a solder bridge between two or more pins, you can usually remove it with the iron, or use a desoldering pump if needed.



Make your own programming language: Running programs

Create your own programming language



Rob Miles

[@robmiles](#)

Rob Miles has been playing with hardware and software since almost before there was hardware and software. You can find out more about his so-called life at robmiles.com.

CREATE FOR FUN

Creating something “because it seemed to be a good idea at the time” happens surprisingly often in the computer world. Both Python and Unix, along with a huge number of other things we use today, originated in this way.

W

e use programming languages to tell computers what to do.

There are lots of different ones and most programmers know a few. But how does a programming language work?

And how do you make one? Let’s find out by looking at Python-Ish, a language created by the author that runs on any computer that supports C++. It works on Arduino devices and on ESP-8266, ESP-32 and Raspberry Pi Pico.

In this part we’re going to focus on how programs run on a robot. In the next part we’ll work with higher level Python-ish statements. You can find all the source code for Python-Ish and how to build a Pico-powered robot here: hsmag.cc/pixelbot

IT STARTED WITH A ROBOT

Figure 1 shows a Hull Pixelbot. You can find out more about these in *HackSpace* magazine issue 74: hsmag.cc/74 The first versions were programmed in C. To make a Pixelbot do something new you had to plug it into a PC and install an updated C program. The author wanted to be able change robot behaviour by just sending new instructions, so he thought it might be a good idea create a language for this. The processor inside the first Pixelbots had limited space for memory and programs, so the language had to be very simple.

WHAT IS PYTHON-ISH?

Figure 2 shows what Python-Ish was built for. You can use it to create a program that takes input from the distance sensor on the front of the robot and controls the Motors, Pixel and Sound elements on the robot. The Python-Ish program is an interpreter. It is a large C program that accepts Python-Ish instructions and then

acts on them. The input to the Python-Ish interpreter program is a string of Python-Ish statements. Let’s look at one:

```
move 100
```

The Python-Ish statement above can be loaded into a robot and will run. It would make a robot move forwards 100mm. This language looks simple enough, but adding more move statements would very quickly fill up the 1,000-character storage available on the Arduino Uno used in the first Pixelbots. So, the interpreter converts this statement into ‘low-level’ code. It does this by searching through a list of high-level command names and finding the low-level command sequence that matches it. We will discover more about how this works in the next article in this series. For now, we are more interested in just how we get the low-level to run.

LOW-LEVEL CODE

Below you can see the ‘low-level’ code that represents the above move.

```
mf100
```

This ‘low-level’ code is smaller than the original program. It is also much easier and quicker to decode. Rather than having to recognise the word ‘move’ a program can use the first character to work out the type of command (in this case ‘move’) and the second character to work out which command is to be performed. We can start by using a C language switch construction to choose a particular action based on the first character of the statement:

```
switch (commandCh)
{
```



```

case 'M':
case 'm':
    remoteMoveControl();
    break;
case 'P':
case 'p':
    remotePixelControl();
    break;
case 's':
case 'S':
    remoteSoundPlay();
    break;
...
}

```

The code above shows how the first character of a command is decoded using the C switch construction. The variable `commandCh` contains the first character of the statement being decoded. The switch works on this value. Each case in the switch specifies a selection value. If the value in `commandCh` matches that value, the code in that case is performed. In other words, if `commandCh` contains 'm' the `remoteMoveControl` function is called. When the `remoteMoveControl` is called it moves on to the next character in the command and repeats the process:

```

switch (commandCh)
{
case 'F':
case 'f':
    remoteMoveForwards();
    break;
case 'R':
case 'r':
    remoteRotateRobot();
    break;
case 'S':
case 's':
    remoteStopRobot();
    break;
...
}

```

In the code above the value of `commandCh` has been updated to hold the second character in the statement, so that the `remoteMoveForwards` function is called when the statement 'MF' is performed. The remainder of the MF statement specifies the distance that the robot should move. Code in the `remoteMoveForwards` function decodes this value and then starts the motors turning. There is a family of move commands, a family of pixel commands and a family of sound commands. We can add new language behaviours by adding new case elements to the switches. We now know how

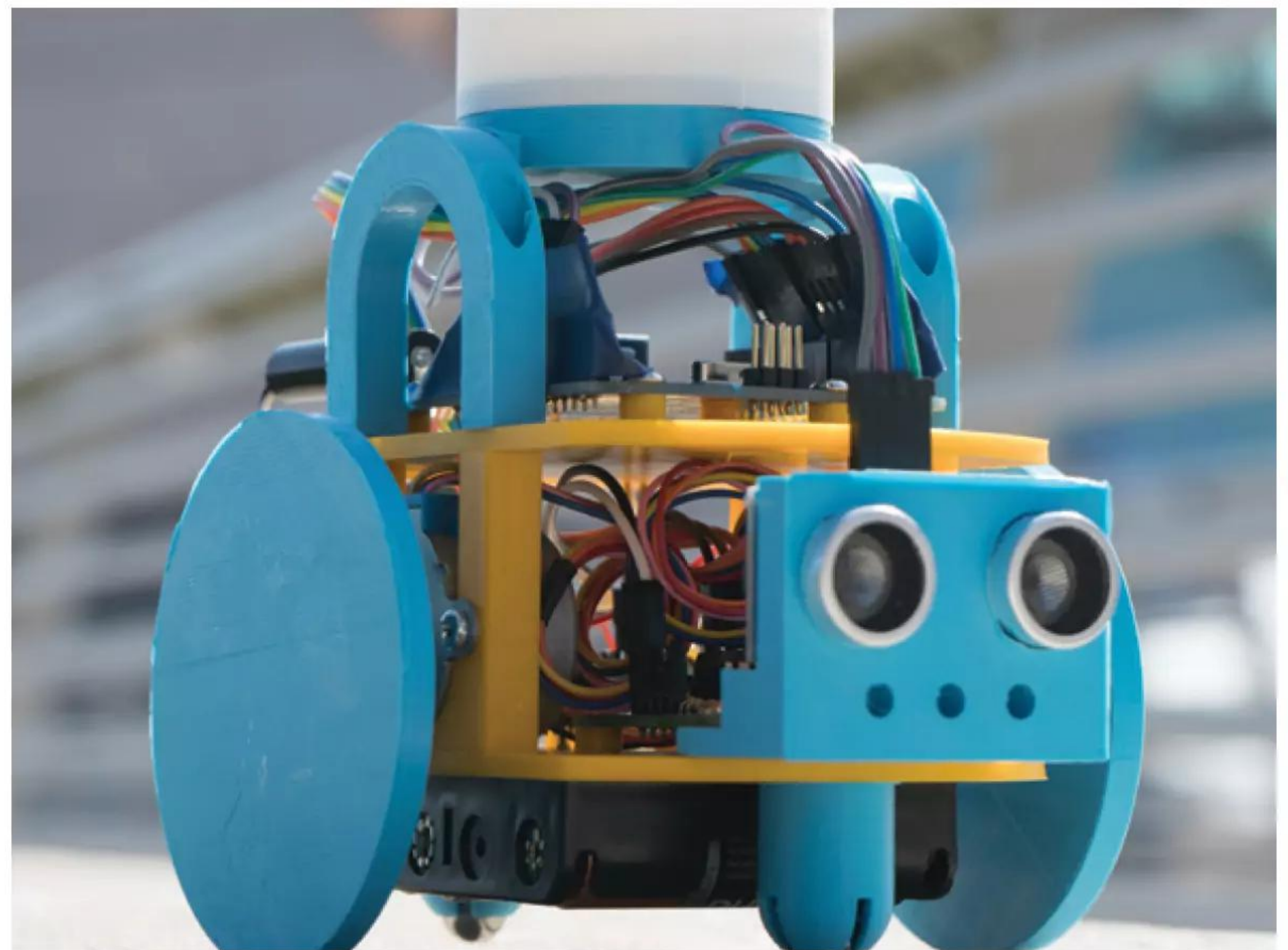

each statement in a program runs. Now we need to discover how the program itself is stored inside Python-Ish.

STORED CODE

Figure 3 shows how a Python-Ish program is loaded into computer memory. Each memory location holds one character of the program, and memory locations are numbered. Memory location 1200 contains M, location 1201 contains F and so on. The variable `decodePos` is declared as a C pointer that can point at a particular location in memory. A pointer holds the number of a particular memory location. You can see that `decodePos` in **Figure 3** holds the value 1200.

```
char *decodePos;
```

Putting a '*' in front of a C variable name causes it to be declared as a pointer. We can 'de-reference' a pointer in a program by using '*':

```
char commandCh = *decodePos;
```

The statement above sets the character variable `commandCh` to the contents of the location that `decodePos` presently points at. If the values are set as in **Figure 3**, this would set `commandCh` to 'M'.

We can move down to the next location in memory by adding 1 to the value in `decodePos`:

```
decodePos = decodePos + 1;
```

This makes it very easy to create C programs that move rapidly through the memory of a computer.

We now know how Python-Ish low level instructions are structured and how they are decoded in memory. Now we need to know how the Python-Ish keeps track of which statement is being performed when the program runs.

Figure 1 It's called the Hull Pixelbot because it was created in the city of Hull in the UK

QUICK TIP

From these code samples you can deduce that program commands can be in capital letters or lower case.

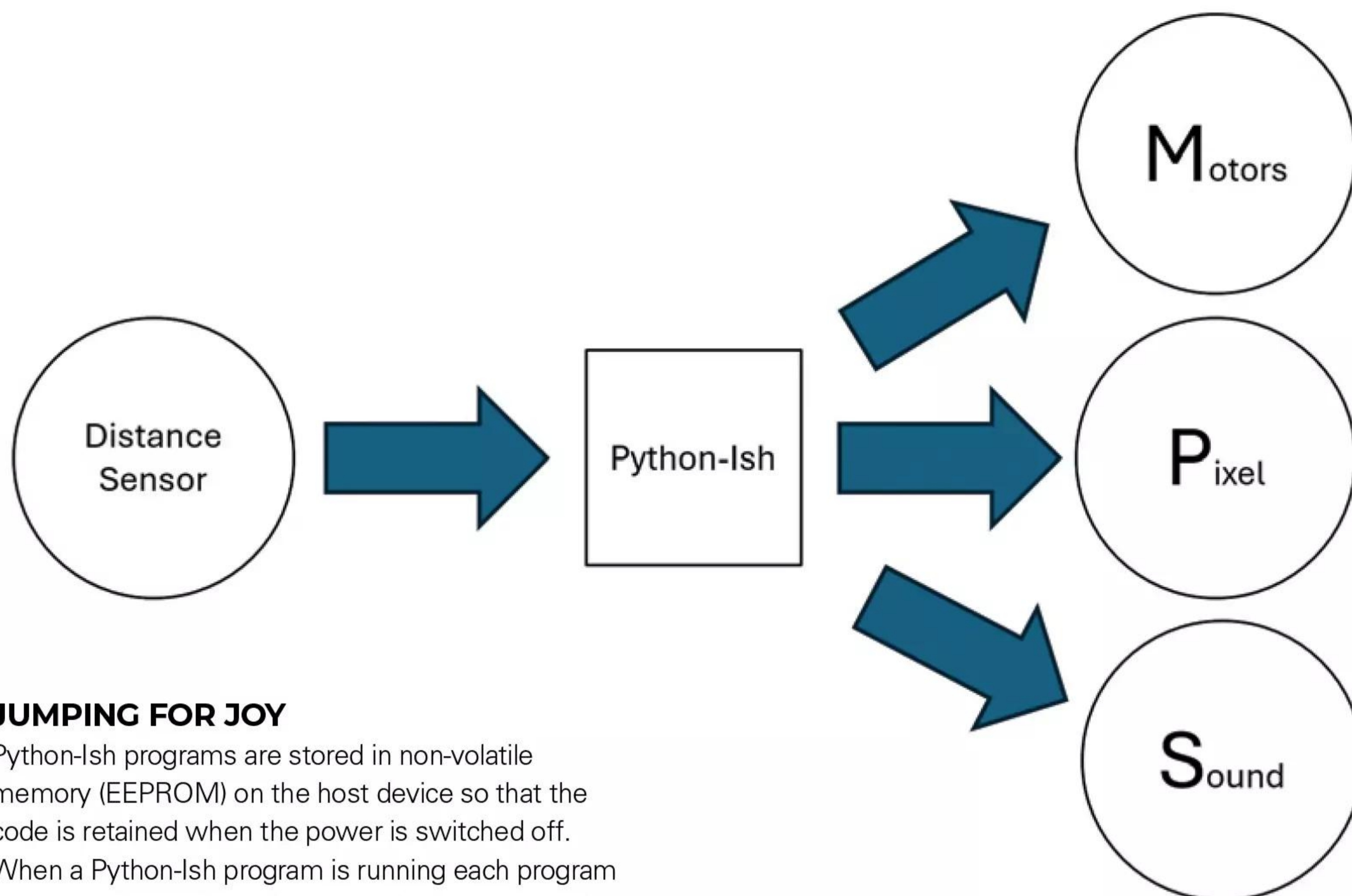



Figure 2  The first robots only have distance sensor inputs, but other inputs can be added

QUICK TIP

You need to be very careful when using C pointers. If you forget to de-reference a pointer (miss the * off) or try to de-reference a pointer that has not been set to a sensible value your program will probably crash.

JUMPING FOR JOY

Python-Ish programs are stored in non-volatile memory (EEPROM) on the host device so that the code is retained when the power is switched off. When a Python-Ish program is running each program statement in turn is fetched from this memory and decoded as we have seen above. A program counter variable keeps track of the current statement being executed from EEPROM.

Sometimes a program needs to change its behaviour in response to a data value (an 'if' construction) or some statements need to be repeated (a loop). This means that Python-Ish must support labels and jumps. To do this we need to have some instructions that control program execution. The low-level commands that control what a program does start with the letter C, for control. Below is a program which uses these to make a robot repeatedly move in a square. Comments have been added to explain each statement.

CL11	create a label called l1
MF100	move forward 100 mm
CA	wait for the move to complete
MR90	rotate the robot 90 degrees
CA	wait for the rotate to complete
CJ11	jump to label l1

The code above would make a robot repeatedly move forward and rotate 90 degrees. It uses three control instructions. The first one is CL which creates a 'label'. This is a point in the program code that can serve as the destination of a jump instruction. The second control instruction is CA. This instruction causes a program to pause while a move completes. It is possible for the robot to move while the program is running, so if the CA statements were omitted the robot would go directly from the move to the rotate. The third control instruction is CJ which performs a jump. When a jump is performed the Python-Ish interpreter searches through the program text for the destination label and then continues running the program from the statement following the label. There are also control instructions which can be used to make a decision based on the value in a variable

```
CCcount<10,l2
```

The statement above is testing to see if the value in the variable count is less than 10. The CC (Control Compare) instruction is followed by something which can be true or false. If the expression is true the program will jump to the given label. In other words, execution will move to l2 if the value in count is less than 10. There is also a CF (Control False) instruction which will jump if an expression is false. Now that we know how to compare variables, the next thing to understand is how variables work.

MAKING MEMORIES

The V family of commands manages variables in Python-Ish. The VS command sets a variable to a particular value.

KEY SKILLS

You might think that to create a programming language such as Python-Ish you'd need to have lots of complicated programming skills. However, this is not the case. There are two fundamental programming activities that are used inside Python-Ish. These are:

- Choosing an action based on a particular value.
- Searching for something in a list.

If you know how to do these things you can create your own programming language like Python-Ish.

QUICK TIP

The program probably won't be stored at memory location 1200, this value is just for the example.

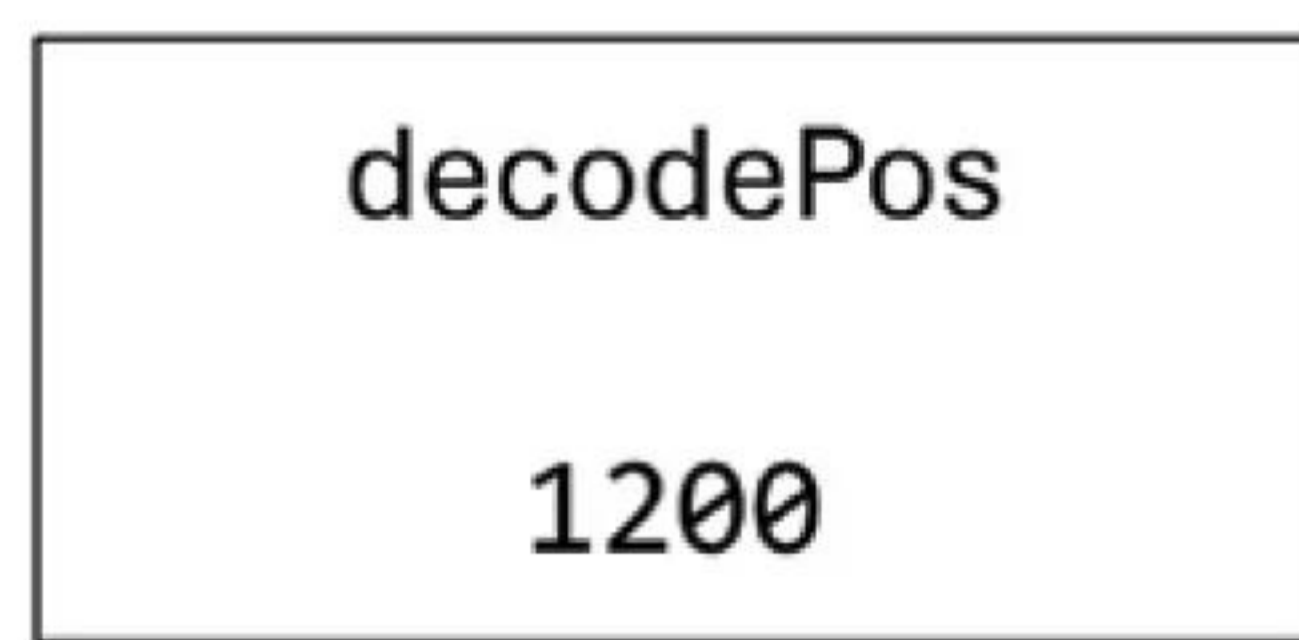

C pointer



Address	Data
1200	M
1201	F
1202	1
1203	0
1204	0
1205	terminator

Figure 3 ♦
The terminator character is a special value which identifies the end of a statement

```
VScount=0
```

The statement above would set a variable called count to the value 0. If count does not exist it is automatically created. Variables are held in a variable structure.

```
#define MAX_VARIABLE_NAME_LENGTH 10
```

```
struct variable
{
    bool empty;
    bool unassigned;
    // add one to the end for the terminating zero
    char name[MAX_VARIABLE_NAME_LENGTH + 1];
    int value;
};
```

A C struct (structure) is a way of bringing several items together to make a named lump of storage. The variable structure contains two flags called empty and unassigned. It also contains an array of characters to hold the name of the variable. Finally, it contains the value in the variable, as an integer.

```
#define NUMBER_OF_VARIABLES 20
```

```
variable variables[NUMBER_OF_VARIABLES];
```

The code above creates an array of variables. Python-Ish programs can have up to different 20 variables. When the interpreter sees an assignment statement it searches the variables list for a variable with that name. If the variable is not found the interpreter creates one. The interpreter can use the empty flag in a variable to find empty locations in the variable array. When a variable is created, its unassigned flag is set to True. The flag is set to False when a value is assigned to the variable. This means that Python-Ish can detect when a programmer tries to use a variable before they have put a value into it. If we want to perform calculations the item following a variable name can be a simple expression:

```
VScount=count+1
```

The statement above would add 1 to the value in count. The expression in this statement (the part after the '=') takes two values (in this case count and 1) and performs the operator (in this case '+'). The result is then set in the count variable. There are also variable commands which can be used to remove all the

VARIABLE VARIATIONS

You might not think you could have much fun with variable names, but the author thinks that you can. When Python-Ish is looking for a variable in the variable list it searches for a variable with a matching name. Shorter variable names are quicker to work through, so you could speed up a Python-Ish program by shortening the names of your variables. The author once wrote a program that scanned through code replacing variable names with shorter ones to maximise speed and minimise size. The BBC Microcomputer from the 1980s (created when memory and computer power were in very short supply) contained an interpreter for the BASIC programming language that used 26 lists of variables, one for each letter. Programmers wanting to get the most out of the machine would spread their variable names around the alphabet.

variables. Python-Ish also has special system variables. These are built-in to the language. Their names start with the @ character. They can be used to get values from sensors into a running program. The variable @distance returns the current distance reading from the distance sensor.

```
V@d=@distance
```

The statement above would set a variable called 'd' to the current distance reading.

PYTHON-ISH POWER

The author thinks that there is nothing quite like making your own programming language. You get that Frankenstein moment when you make something that is kind of alive and can follow instructions that you give it. He also likes the idea that once you have built a language of your own there is less magic about other programming languages. You can start to understand how they work too. In the next instalment we'll discover how to use our low-level from Python-Ish code. □

QUICK TIP

The #define statement creates a 'macro' telling C to substitute the string on the left (MAX_VARIABLE_NAME_LENGTH) for the value on the right (10) when the program is built. This makes programs clearer and makes it easier to change values, for example if we needed to build a version of Python-Ish that supported longer variable names.

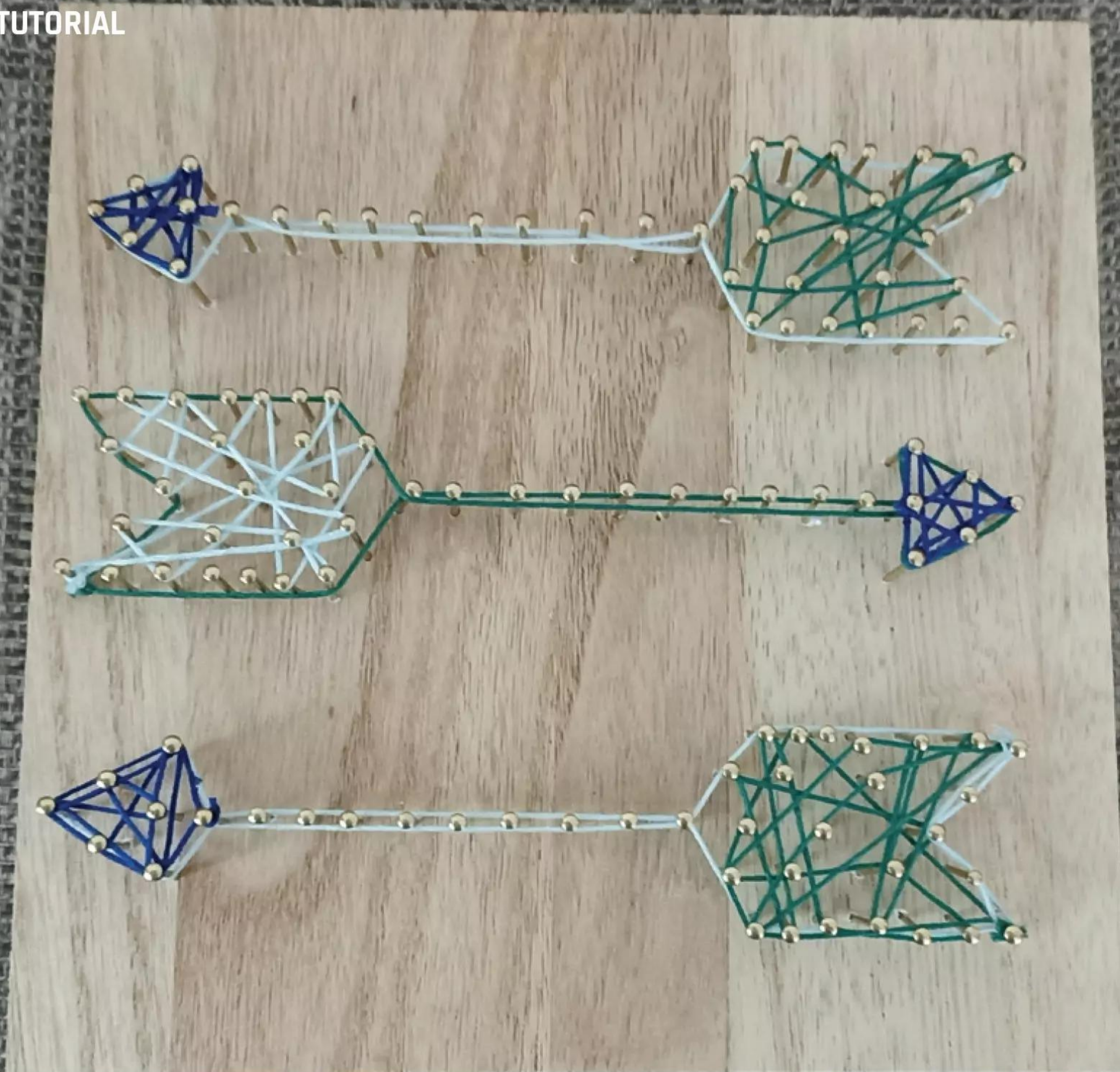

String art

Create a piece of retro-chic art for your walls and step back to the 1970s



Nicola King

[@holtonhandmade](#)

Nicola King is a freelance writer and sub-editor. She'd like to qualify this piece by reiterating that she was very (very!) young in the 1970s, and barely remembers the decade... really!

A

n abiding memory from this author's childhood is of a picture that hung on her grandmother's wall. It was a piece of string art that her uncle had made, and took the form of

a geometric shape constructed of white thread tightly strung around a number of tiny nails on a black background. If you were to ask this particular writer what encompasses the 1970s to her, that picture, along with the general unfathomable penchant towards brown/earthy-toned décor, would be her answer.

In this tutorial, we are going to take a look at string art, a pastime which essentially uses coloured string, yarn, or thread of some kind, along with some nails and a board, to create various

Above

For a first attempt, we were happy with this. There really is no wrong way to thread and weave around the nails; just don't let the string slacken, as poor tension will ruin the picture. You can even try threading two strings around the image, one on top of the other, to give more depth

geometric patterns. Given the recent trend in this author's articles to cover crafts that have a distinct crossover with mathematics (we've looked at tessellations and mathematical shapes made from yarn, to name but two), a dalliance with string art seems highly appropriate. In fact, if you take a look at the 'Ahead of the Curve' box, you'll see that the invention of this art form has been credited to a female mathematician way, way before its better-known 1970s revival. As Mary Everest Boole was aware many decades ago, you can obviously

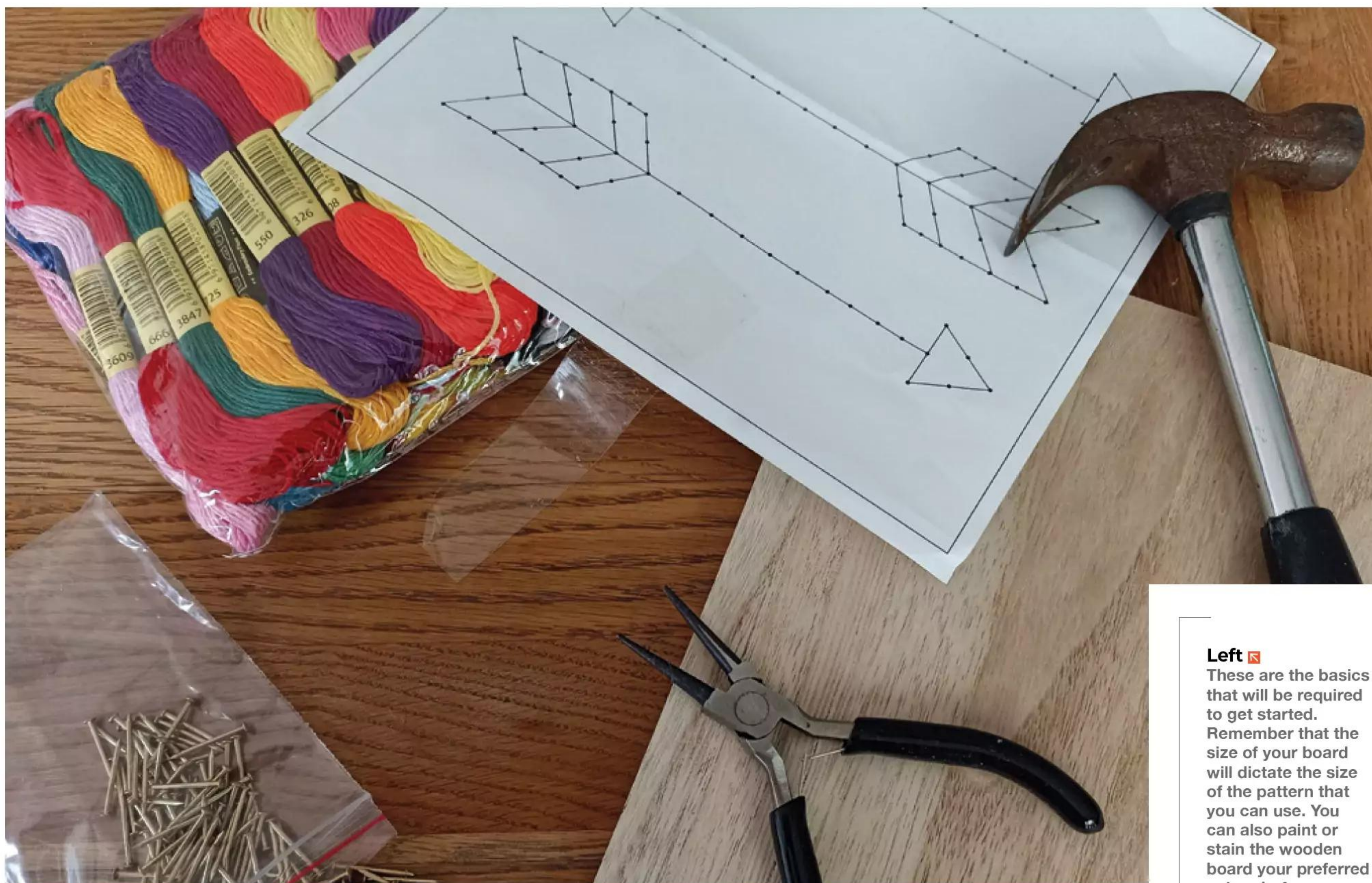

Left  These are the basics that will be required to get started. Remember that the size of your board will dictate the size of the pattern that you can use. You can also paint or stain the wooden board your preferred colour before you get stringing, but do leave a decent length of time for it to dry before you set to with your hammer and nails!

make shapes such as squares, triangles and so on with string art using straight lines, but you can also make things like beautiful parabolic curves with lots of straight lines positioned in a certain way. This was, and still is, a great way for children to explore geometric shapes and enhance their fine motor skills, but you might want to undertake any required hammering of nails.

NAIL IT

In terms of the wood that you need to use for a project like this, plywood works really well, and our *Pictures With Pins* 'manual' suggested it should have a depth of at least 13mm. Our wood piece is 20cm by 20cm square, and we decided to leave it blank before we started working on it. If you want to decorate the base in any way, such as covering it with fabric, felt, or even a 1970s-vibed hessian, then ensure that you do that before undertaking the steps below. With your base and pattern template to hand, you're ready to get underway.

It's always a good idea to have two copies of your pattern to hand, as one will be taped to the board and then removed, but the other can be used for reference while you string your piece. If you search online, you can soon find a multitude of free template patterns to work from or, alternatively,

STRING ART'S ZENITH

We've alluded to the fact that the high point of string art's popularity occurred some decades ago. A company that was central to the rise of stringing up a piece of art for the wall was Open Door Enterprises, an American business that really saw the potential for a string art craze in the 1970s, and was a leading distributor of hobby craft-type kits to the masses. John Eichinger, a US artist, created some geometric string designs in the late 1960s, labelling them 'string mandalas', and some of these were marketed by Open Door Enterprises. A huge number of such kits were sold around the world during that decade, although many are now probably in people's garages or lofts, or languishing in a charity shop.

A lot of those vintage 1970s kits had black or brown backgrounds to them, often a black felt or velvet or sometimes burlap, which certainly tallies with this author's memory of the piece on her grandmother's wall. If you scout sites like Etsy and eBay, you can probably find an original retro kit if you are craving true 1970s authenticity. Owls and other birds, dragonflies, and ships and sailing boats seemed particularly popular options, and one of things that stands out about these 1970s creations is that they were very geometric, in as much as straight lines were often used to form elaborate shapes, whether that was a starburst design or a very angular-looking vase.

YOU'LL NEED

- ◆ **Nails**
- ◆ **A hammer** (for use with nails and wood base)
- ◆ **A suitable board/base** (e.g. plywood)
- ◆ **'String'** (string, thin yarn, embroidery thread, raffia etc.)
- ◆ **Printed template** (the design for your picture)
- ◆ **Adhesive tape**
- ◆ **Pliers** (optional)
- ◆ **Squared graph paper/pencil** (optional)
- ◆ **Fabric** (for covering board – optional)

QUICK TIP

As a first project, try to use an image or pattern that has simple, uncomplicated outlines. It will be quicker to complete and you'll avoid 'first project failure' syndrome.

Right ♦

If I had a hammer! Try and hammer the nails in as straight and true as possible. This pattern used just over a hundred one-inch nails. *Pictures With Pins* even suggests making an image purely from nails, filling in the middle of an image with nails too. Frankly, that's a lot of precise hammering and potential finger bashing, and their examples weren't that attractive!

draw up your own idea on a sheet of squared paper to make something really personalised. If you do make your own pattern, it's worth knowing that the generally accepted spacing distance between each nail appears to be around 1cm – so mark these points on your pattern with a pencil. We used a design that came with a very inexpensive kit, and 1cm was the spacing that it followed.

Stick your design to the right side of your board with some tape, and then begin to hammer the nails into each dot, through the paper, along the perimeter of the shape. Don't hammer the nails in too deeply – just make sure they are all at the same depth and are fully stable within the board. We used one-inch nails and found they worked perfectly. Some makers like to match the colour of their thread to their nails but, for your first piece we'd suggest that's really not necessary.

We used a fairly lightweight hammer to first gently tap them in, and then to properly embed them in the base. You really don't want to be using a hammer that is too heavy for this task. You could, if you wished, also use a depth gauge to make sure that the nails are all the same height once hammered in – a small block of wood would be a great hack for this.

STRING IT OUT

Now that the nails are in place, the next step is to remove the paper that you taped to the board,

AHEAD OF THE CURVE

Mary Everest Boole (1832 – 1916) was the wife of English mathematician George Boole, himself a pioneer in the application of mathematical ideas to logic, and the man who had Boolean algebra named after him. Mary was an accomplished mathematician in her own right and one who particularly enjoyed algebra. She actually laid the foundations of modern string art with her 'curve stitching' or 'string geometry' technique, and is regarded by many as the inventor of string art.

Mary was somewhat ahead of her time when it came to teaching children mathematics, and favoured a progressive, direct, hands-on learning approach. In order to convey mathematical ideas and patterns to young people so that they could grasp them better, specifically algebraic curves and the geometry of angles and spaces, she used curved stitching, or the practice of stitching coloured threads through a pattern of holes pricked in cardboard. This made learning for her students a much more interactive process.

In 1909, Mary Everest Boole published a book called *Philosophy and Fun of Algebra* which was something of a groundbreaking work at the time as it presented algebra as a mathematical subject, but also as a tool for developing problem-solving skills. Given that it was published some time ago, it's generally agreed that her writing style was very engaging and accessible, and this book is still used and referenced today.

Overall, it can be argued that devoted mathematician Mary Everest Boole was something of an innovator in both the fields of women's education and the development of mathematics, with her creative teaching techniques that aimed to stimulate geometric imagination and her belief that logical thinking was empowering.



which is much easier to do now before you start stringing rather than later when your piece of art is complete. If any small pieces of paper are stuck around the nails, use your pliers, or even some tweezers, to pull them gently away.

If possible, get a long length of string ready, or whatever thread you are using, as this will mean that you won't have to make as many joins later in your work. Joining one piece of string to another needs to be done very carefully once you are underway, as joins should really be made at a nail. If you make too many joins throughout the piece and don't try to hide them, your picture will be marred by some unsightly knots.

The 1970s book that we procured – *Pictures With Pins* – contains very precise and detailed information on how to thread each picture. They



map out the design with a kind of numbering system and direct the maker from C3 to C4, A5 to A8, etc. If you want to create a complicated design, then precise directions are probably needed, but contemporary string art kits or the DIY approach can be much more haphazard and random, so don't worry that the threading element is going to be overly complicated.

Tie your thread or string to the first nail, securing with a knot, and leave a decent length tail for tying off when you are finished. We now want to outline the perimeter of the image with our thread. We decided to use an embroidery thread, and used all six threads, as removing any would mean our thread was weaker and could possibly break when pulled taut.

Your choice of thread or string will depend very much on what you want your finished project to look like, and whether you want a thin, delicate look, or something more rustic. You only need to make one wind around each nail as you go, and it's important to remember not to pull the string or thread too tightly as you go or you risk forcing your



The generally accepted spacing distance between each nail appears to be around 1cm



nails inwards, and they could even come out of the base. Just pull the thread so it fits snugly around each nail but is not too tight – practice will help with finding your rhythm.

FILL ME IN

With the outside of the shape now defined, you can then start to fill in the middle area of the pattern, criss-crossing and wrapping from one nail to another, and it's completely up to you how you fill in your design. You can be very methodical about filling the inside and follow a pattern or, as seems to be generally a more popular approach and the one that we used, you can simply adopt a

Above

The 'string' that you use will have a lot to do with how the picture turns out. Something in a nylon, for example, might have more of a shine to it than a hemp or parcel string, so it might reflect light better



ADD A STRING TO YOUR BOW

This might be the cheapest, easiest, and most accessible new hobby idea that we've ever written about – you only need a board, some nails, and something to wind around them. It could also prove to be an interesting side hustle, as a quick search of Etsy found plenty of examples of people making string art and selling it... just saying! So, if you are now keen to give string art a go, here are some ideas for useful resources that might help you tie up your new hobby:

- **Buy a kit** – if you don't own all of the items required, an inexpensive craft store kit will suffice, although you will probably need to find your own hammer. We had no idea that so many kits actually existed until we searched online, so the craft clearly appears to be having a resurgence. Prices are very reasonable, so they can make a great holiday gift idea – hsmag.cc/StringArtKit.
- **Borrow a book on the subject** – once again, your local library might be a good source of knowledge, and you can always order a book from another library if your nearest does not have it. Or, scour those charity/thrift stores to see what crafty volumes they have hidden on their shelves. As well as *Pictures With Pins* (1974) which might now be a little tricky to get hold of, another appropriate tome might be *String Art Symmography* (1971) by Lois Kreischer – 3D creative string art designs that positively scream 1970s! A more contemporary read would be *DIY String Art* (2016) by Jesse Dresbach, or *The String Art Dot-to-Dot Book* (2019) by Patricia Moffett.
- Take some inspiration from contemporary artists who are pulling the strings of this art form into the modern day. Gabriel Dawe, for example, is a Mexican artist based in Dallas who is renowned for his 'Plexus' installations – take a look at these and you'll never see thread in the same way again (hsmag.cc/Plexus). Or, how about self-taught string artist Ben Koracevic, whose string art images encompass the fields of icons, culture, nature, and even cities (stringometry.com and hsmag.cc/TheStringArtGuy)?
- Find some free templates to use to get you underway quickly. Alternatively, you can pay a small amount for slightly more complicated patterns... the choice is yours – hsmag.cc/StringArtPatterns.

Above ♦

Dating from string art's 1970s upswing period, this second-hand book purchased for £1 (!) contains designs for 'thread sculptures' of goldfish, snowflakes, goblets, the signs of the zodiac, and a ballerina, to name just an eclectic few. If you are looking to add a 1970s vibe to your décor, this is the book for you

completely random, unsystematic approach and run the thread wherever you please, making the inner part as sparse or dense as you wish. Keep going until you're happy, then tie off the end with a knot when you're finished. Snip off any stray thread tails, or try to tuck them inside your work, and you are done!

So, if you're tempted to create a piece of art from string, give it a go. Some contemporary string art kits do reflect that geometrical obsession of the 1970s, but they also give makers a chance to show their creative freedom. The work of some of the exciting current string art artists and creatives includes many ultra-modern patterns, and often exhibits their own mathematical perceptions, so seek some modern inspiration from their stringing skills.

The basics of string art are not difficult to grasp, no special skills are required, and a complicated picture does not require any more expertise than a simple one, just more time and, of course, more nails and string. Latch on to the basics of the craft, and then let your senses for colour and texture take over. □

The parts we sell help get you there safely



Today's cutting-edge vehicles can contain hundreds of sensors for systems that keep you comfortable, entertained, informed, and most importantly, safe.

The sensors we sell help engineers create these systems, but helping you enjoy your journey safely is what really drives us.

Find sensors for any application at digikey.co.uk

DigiKey

we get technical

DigiKey is a franchised distributor for all supplier partners. New products added daily. DigiKey and DigiKey Electronics are registered trademarks of DigiKey Electronics in the U.S. and other countries. © 2024 DigiKey Electronics, 701 Brooks Ave. South, Thief River Falls, MN 56701, USA

ECIA MEMBER
Supporting The Authorized Channel

ONLY THE
BEST

RP2350 Boards

Unleash the power of the RP2350 microcontroller with these boards

By Phil King

The chip that powers Raspberry Pi Pico 2, the RP2350 microcontroller, has also been used in an array of third-party boards, while even more are in the works. The RP2350 itself offers a considerable upgrade over the original Pico's RP2040, featuring dual Arm Cortex-M33 processor cores running at 150MHz (vs 133MHz), 520KB of on-chip SRAM (vs 264KB), and 12 PIO state machines (vs eight). So it offers a performance boost and is better at handling more complex computational tasks.

Not only that, but there's the bonus feature of two open-hardware Hazard3 RISC-V cores which can be substituted at boot time for the Cortex-M33s, so you can switch between them depending on your needs.

All of this means that RP2350 offers a whole lot of power and flexibility, resulting in a wide variety of boards and other products making use of it. We take a look at just a few of them here, but you can check out the full product catalogue at hsmag.cc/rp2350catalogue.

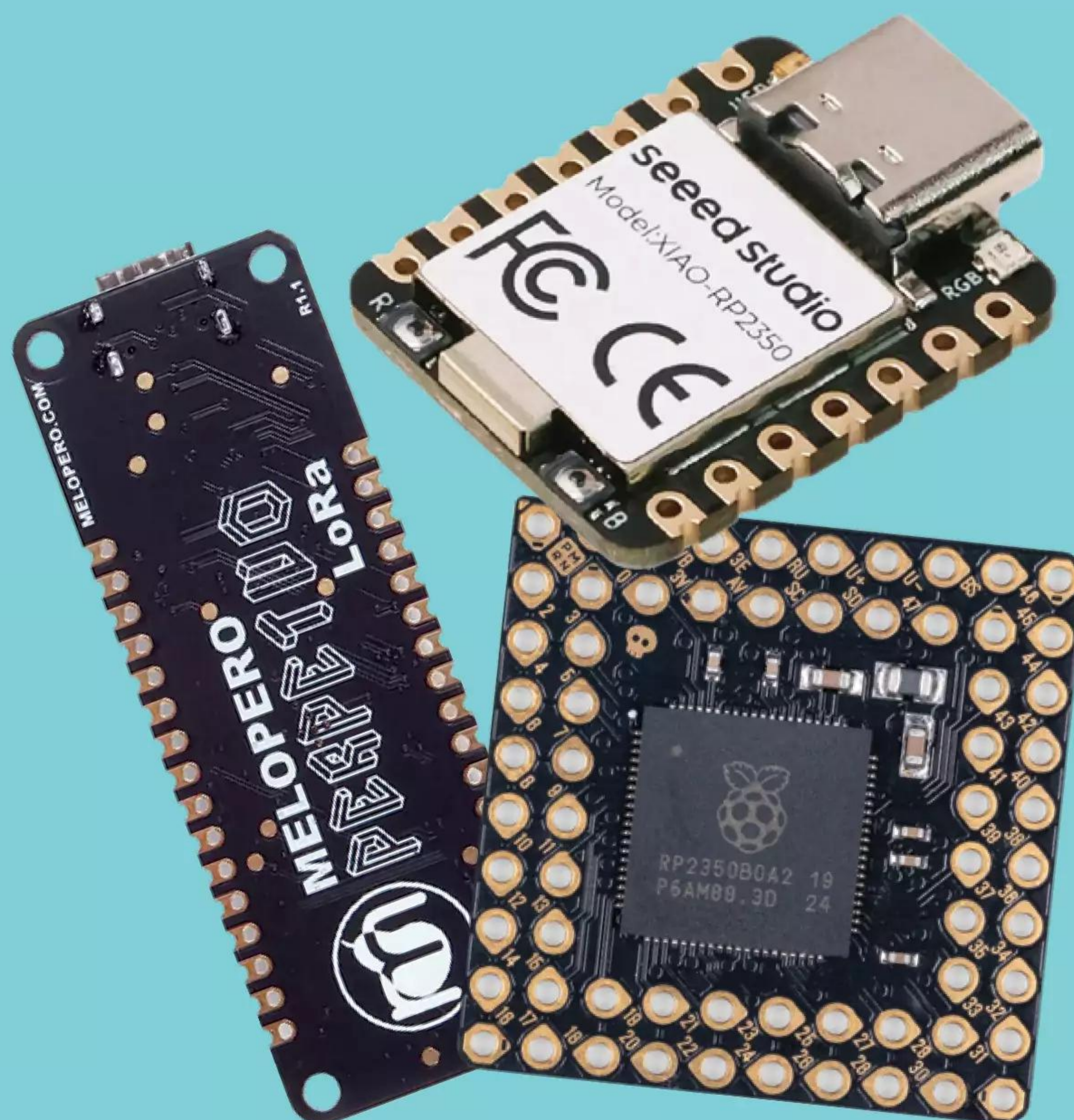

Pico Plus 2 vs Pro Micro – RP2350

PIMORONI ♦ £13 / \$14 | pimoroni.com

SPARKFUN ♦ £14 / \$15 | sparkfun.com

Packing extra features over a standard Raspberry Pi Pico 2, this is one of the few third-party products to be based on the RP2350B variant of the microcontroller chip, which offers an extra 18 GPIOs and four additional analogue inputs.

Some of those extra GPIOs are broken out here via an eight-pin SP/CE edge connector for hooking up SPI/serial devices – located on the rear, it means the board won't quite sit flat. There are also QW/ST and Debug mini headers on the top. Other than that, it maintains the standard Pico form factor and 2x20-pin layout, so is compatible with existing Pico add-ons.

Other notable upgraded features on the Pico Plus 2 include a handy reset button, 16MB of QSPI flash supporting XIP (execute in place), and 8MB of PSRAM. The boot button also doubles as a user button.

If you need wireless connectivity, there's a Pico Plus 2 W variant with 2.4GHz Wi-Fi and Bluetooth.

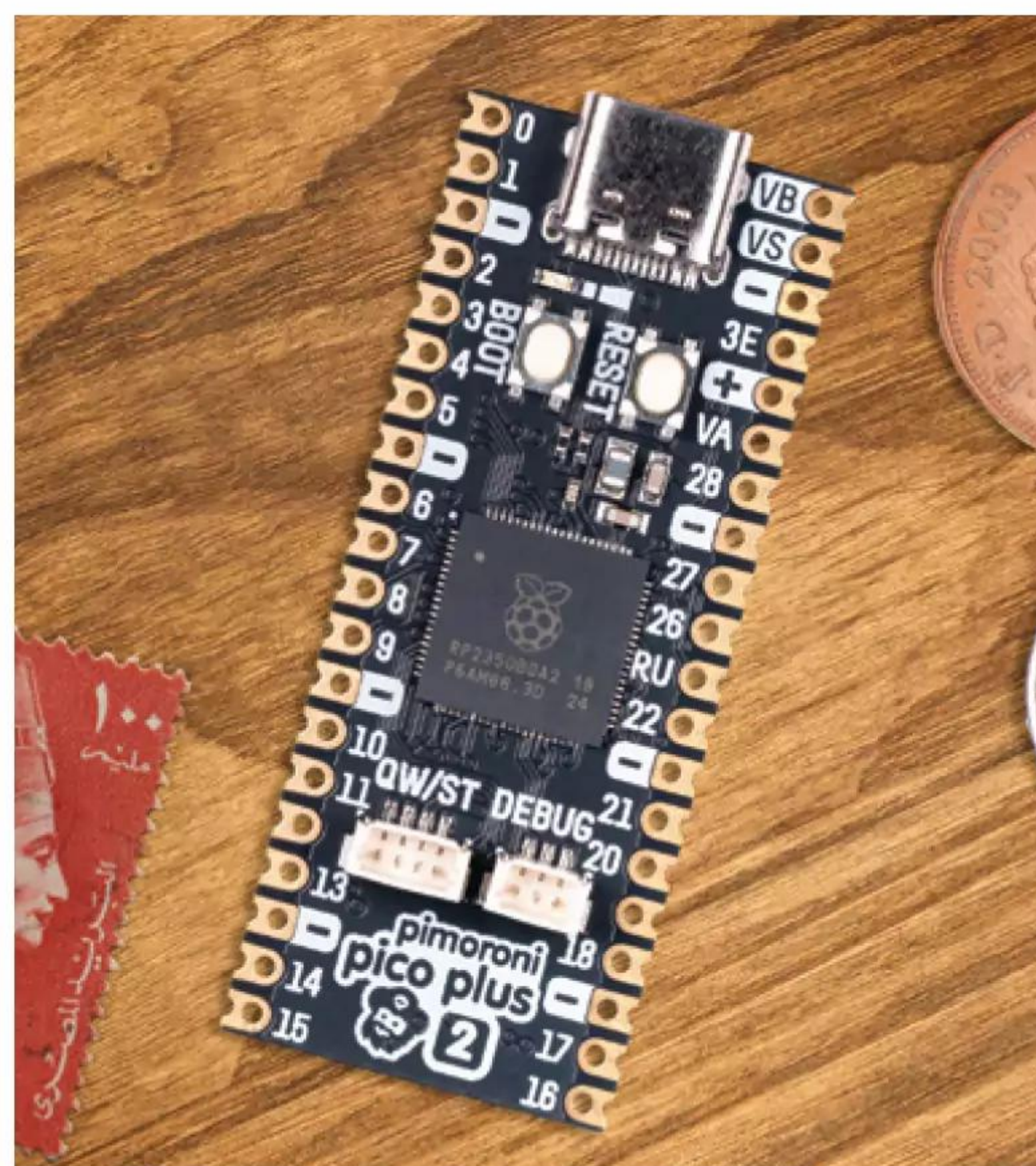

Left The Pico Plus 2 maintains the standard Pico layout while adding extra pins and features

As the name suggests, SparkFun's general-purpose RP2350 board has a more compact form factor than Pico (and thus Pico Plus 2) – 33x17.8mm (1.3x0.7in), matching other products in the firm's line-up.

A downside of this is a reduced 24-pin layout (the same as on the earlier RP2040 version of the Pro Micro), so only 18 GPIOs are broken out on the edges, plus a couple more via a Qwiic connector. This also means that the RP2350's HSTX (High-Speed Serial Transmit) mode is not supported.

Still, there are four analogue inputs on offer, along with two UART interfaces and SPI, plus I2C via that Qwiic connector.

The board also packs 16MB of flash storage and 8GB of PSRAM, matching

Pico Plus 2. Other features include a handy reset button, WS2812 RGB LED, and red power LED.

So, unless you need a whole lot of pins, this board is a good compact option, though not the smallest on the market.

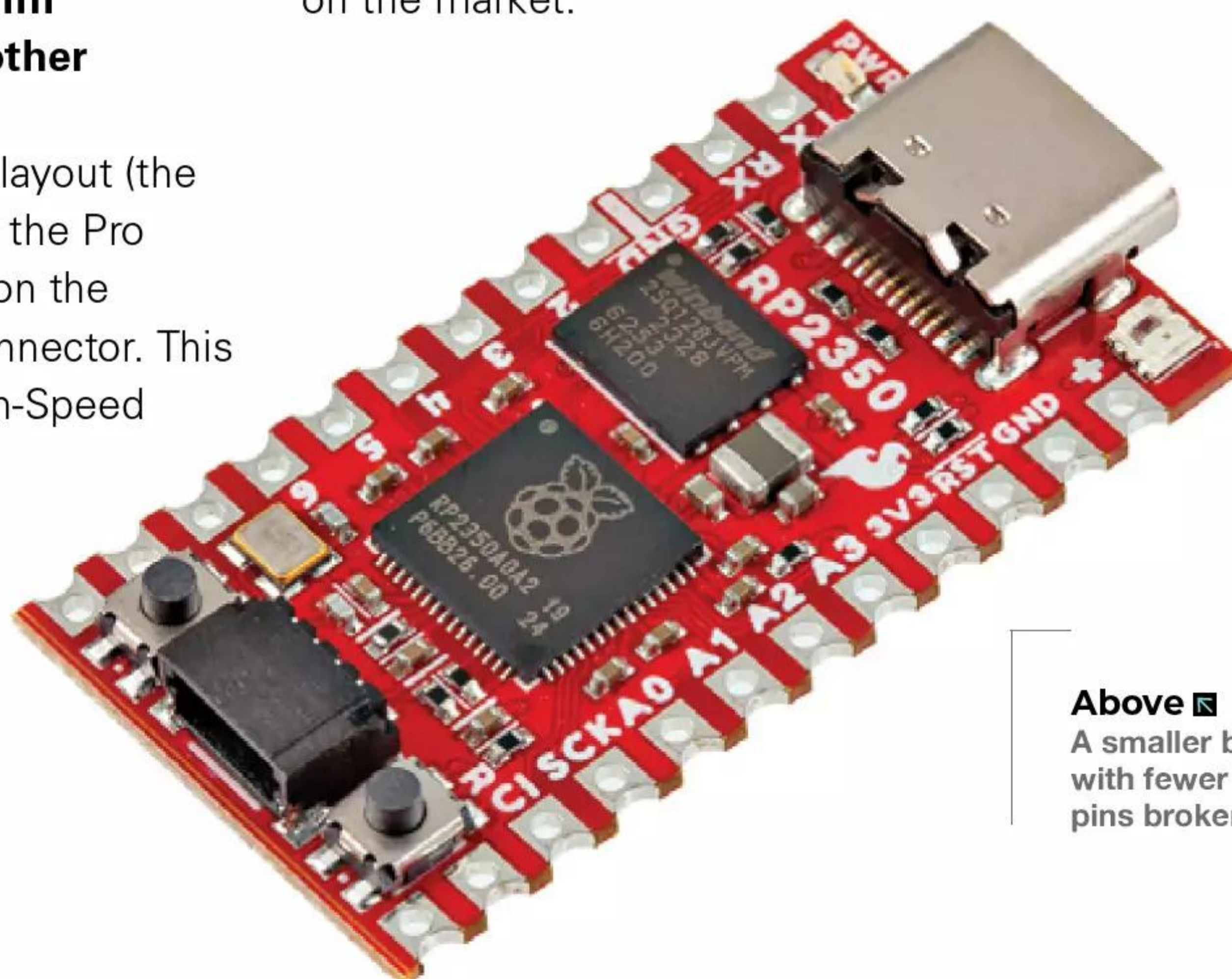

Above A smaller board with fewer pins broken out

VERDICT

Pico Plus 2

Plenty of RAM, flash storage, and extra features to play with

9/10

Arduino Make Your UNO

A compact board with extra features, but a reduced pin layout.

8/10



Thumby Color

TINYCIRCUITS ♦ £38 / \$49 | color.thumby.us

A major upgrade over the original Thumby itty-bitty games console, this mini marvel features a vibrant 0.85-inch colour TFT LCD screen with 128×128 resolution. While its predecessor had a Game Boy-style design, the Thumby Color resembles a miniature Game Boy Advance.

It comes in two versions: the standard KickStarter model with a plastic case (featuring a hole to attach a keychain), and the developer version with no case but

larger buttons. Both feature a LiPo rechargeable battery for around two hours of portable power.

The power of the RP2350 chip enables the Thumby Color to run fairly complex games with full-colour graphics and sound – via a tiny speaker. Its 16MB of flash is preloaded with six games, including *Bust A Thumb*, *4 Connect*, *Solitaire*, and *Thuncheon II*. They're fun to play, although you may need to hold the screen up close to see the detail!

Best of all, you can program your own MicroPython games for it in an online code editor or a standard IDE.

Above ■
Is this the tiniest games console in the world?

VERDICT

Thumby Color

A tiny, fully functional games console that you can program

9/10

XIAO RP2350

SEED STUDIO ◆ £4 / \$5 | [seeedstudio.com](https://www.seeedstudio.com)

Sometimes you need something a little smaller to fit into a tight space for your compact project, such as a wearable. For this, there are a few RP2350 boards that may suit, including the Pimoroni Tiny 2350, Phyx Rick TNY, and Seeed Studio RP2350.

Seeed's board packs an incredible number of features into the firm's XIAO form factor, with the board measuring a mere 21×17.8mm. While this only leaves room for 14 pins, including 11 GPIOs, a further eight GPIOs are broken out via tiny connector pads on the rear.

There are also rear pads to connect a battery. With ultra-low power consumption (27µA in sleep mode),



Above ▣ This tiny board breaks out more GPIOs on the rear

the board has a battery management system with direct battery voltage measurement.

Other notable features include (annoyingly) tiny boot and reset buttons, three LEDs (including an RGB one), and 2MB of PSRAM.

VERDICT

Proof that good things can come in small packages

8/10

PGA2350

PIMORONI ◆ £9 / \$10 | [pimoroni.com](https://www.pimoroni.com)

We mentioned the RP2350B variant of the microcontroller chip earlier. On the PGA2350, every single pin is broken out in a PGA (pin grid array) form factor – all in a 25.4mm square footprint. It also packs 8MB

PSRAM and 16MB of flash.

There are 64 unpopulated pins in total. Of these, 48 can be used as GPIOs – 18 more than a standard Pico 2 – and eight double as analogue inputs.

Standard 2.54mm (0.1in) Pico pin headers can be used to populate the holes. Note that there's no USB connector, though, so you'll need to wire up a USB breakout to start programming it. There's no boot button either – you have to connect the BS and

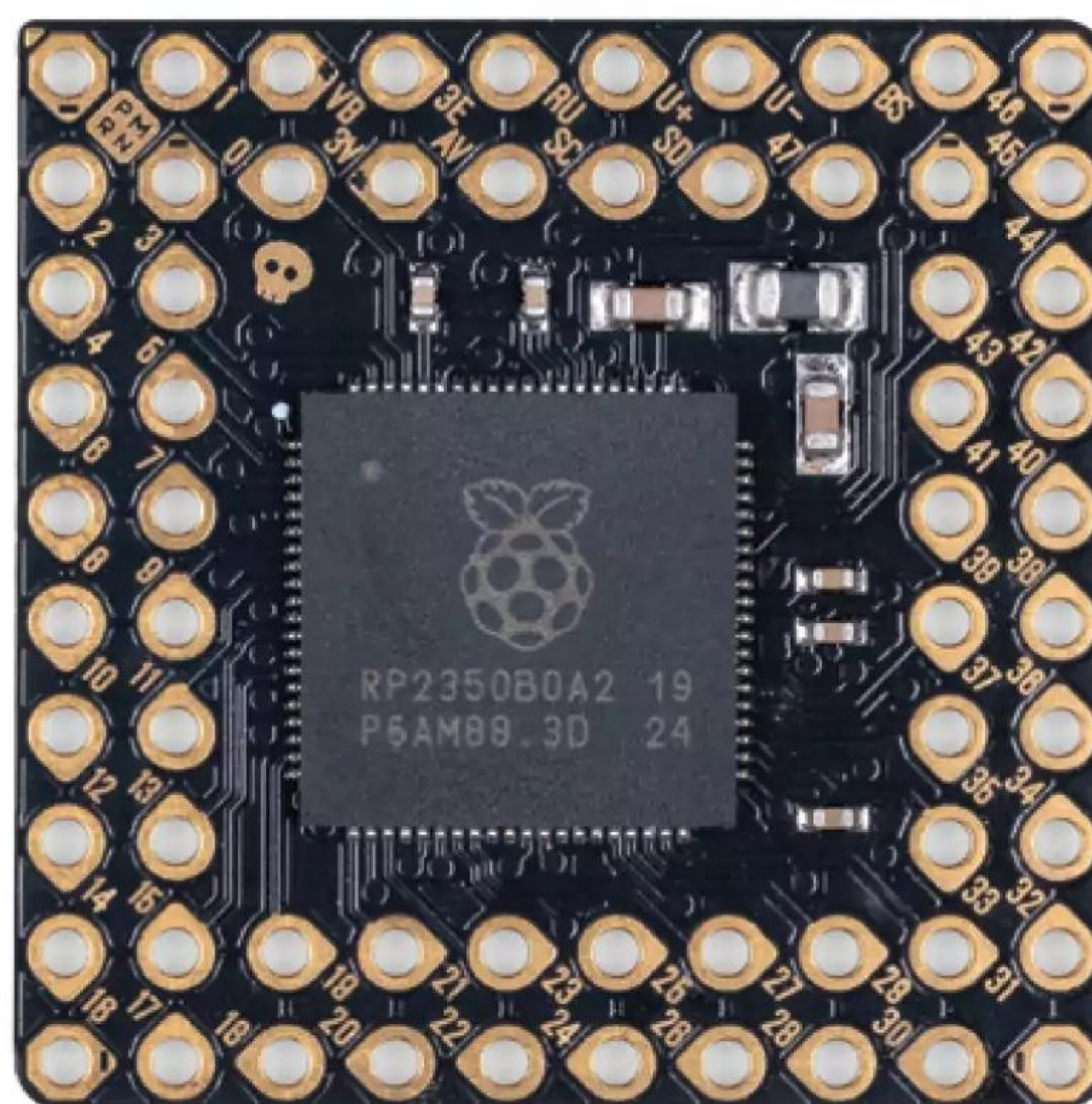

Left ◆ One for the more advanced user, it breaks out every single pin

GND pins with a piece of wire/metal to put it into boot select mode to flash the firmware. Mind you, it is aimed at advanced users wanting to start building their own boards.

VERDICT

PGA2350

Ideal for delving deeper into the RP2350B chip

8/10

Perpetuo LoRa

MELOPERO ◆ £21 / \$27 | melopero.com

R P2350 boards – including Pico 2 W – are now emerging with embedded Wi-Fi and Bluetooth connectivity.

But if you need something with a longer range, the Perpetuo LoRa is a good option to communicate with a LoRaWAN network gateway – for instance, using a LoRa HAT on a Raspberry Pi computer.

Equipped with a LoRA radio module, the Perpetuo operates on the UK/European standard 868MHz carrier frequency, offering robust long-range communication once you add an external RF antenna.

With a low-power mode, it's also energy efficient. Power is provided by a LiPo battery (not supplied) rechargeable via the USB-C port, and it can be used with an optional solar panel, to keep the board running indefinitely when it's off-grid. A Qwiic connector makes it easier to add a sensor, too. There are also 32 standard pins, including 20 GPIOs.

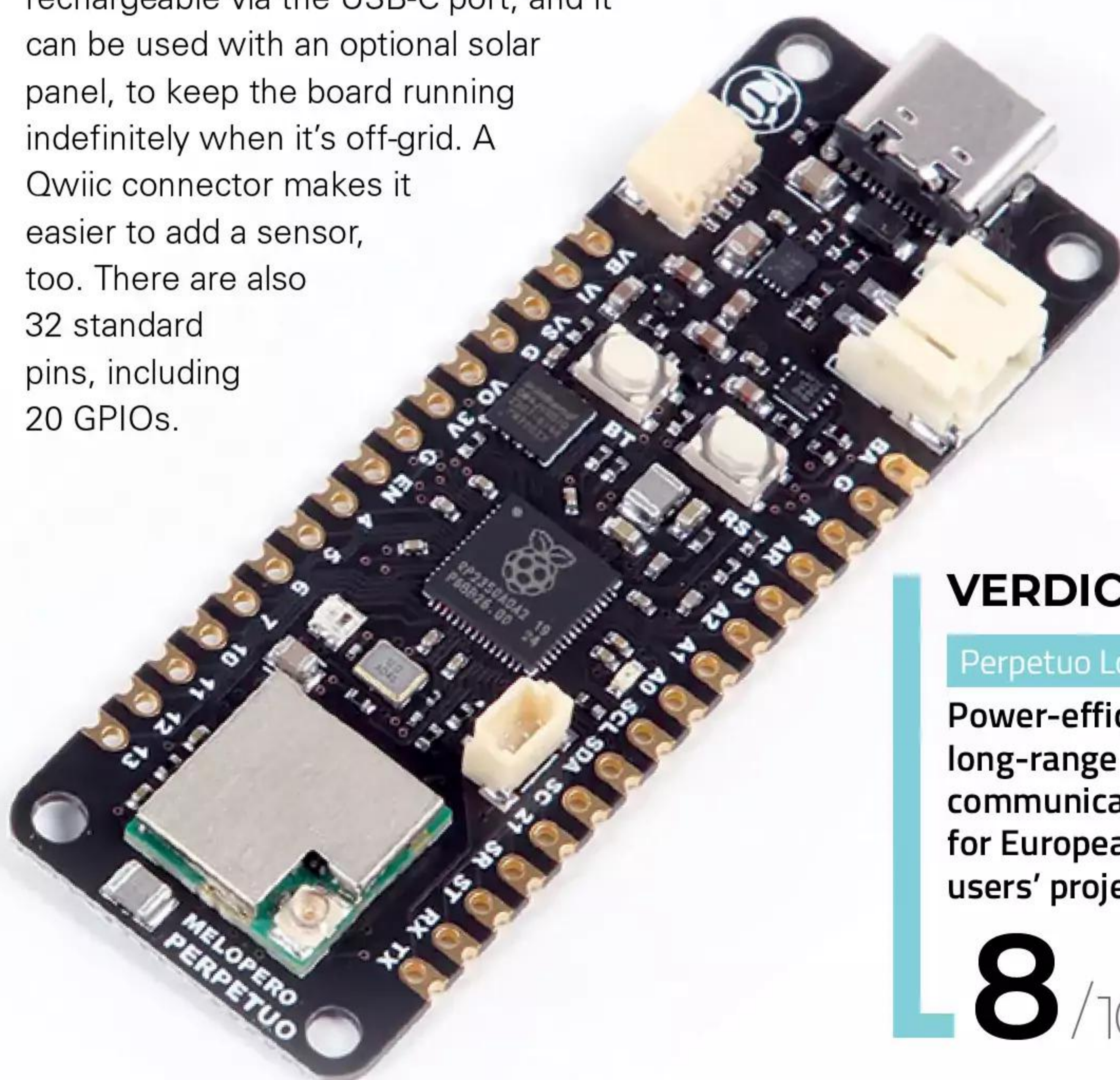

Below ▣
Long-range connectivity on the 868MHz band for IoT projects

VERDICT

Perpetuo LoRa
Power-efficient long-range communication for European users' projects

8 / 10

PICO JUMBO

PIMORONI ◆ £16 / \$17 | pimoroni.com

How's this for a bit of fun? A jumbo-size Pico 2 board! Measuring 180×73.5mm, it breaks out all the pins from a standard Raspberry Pi Pico 2 soldered to the rear. You can use crocodile clips to connect electronic circuits to them. There's also a handy reset button. It's not very practical, but could be useful in an educational setting.

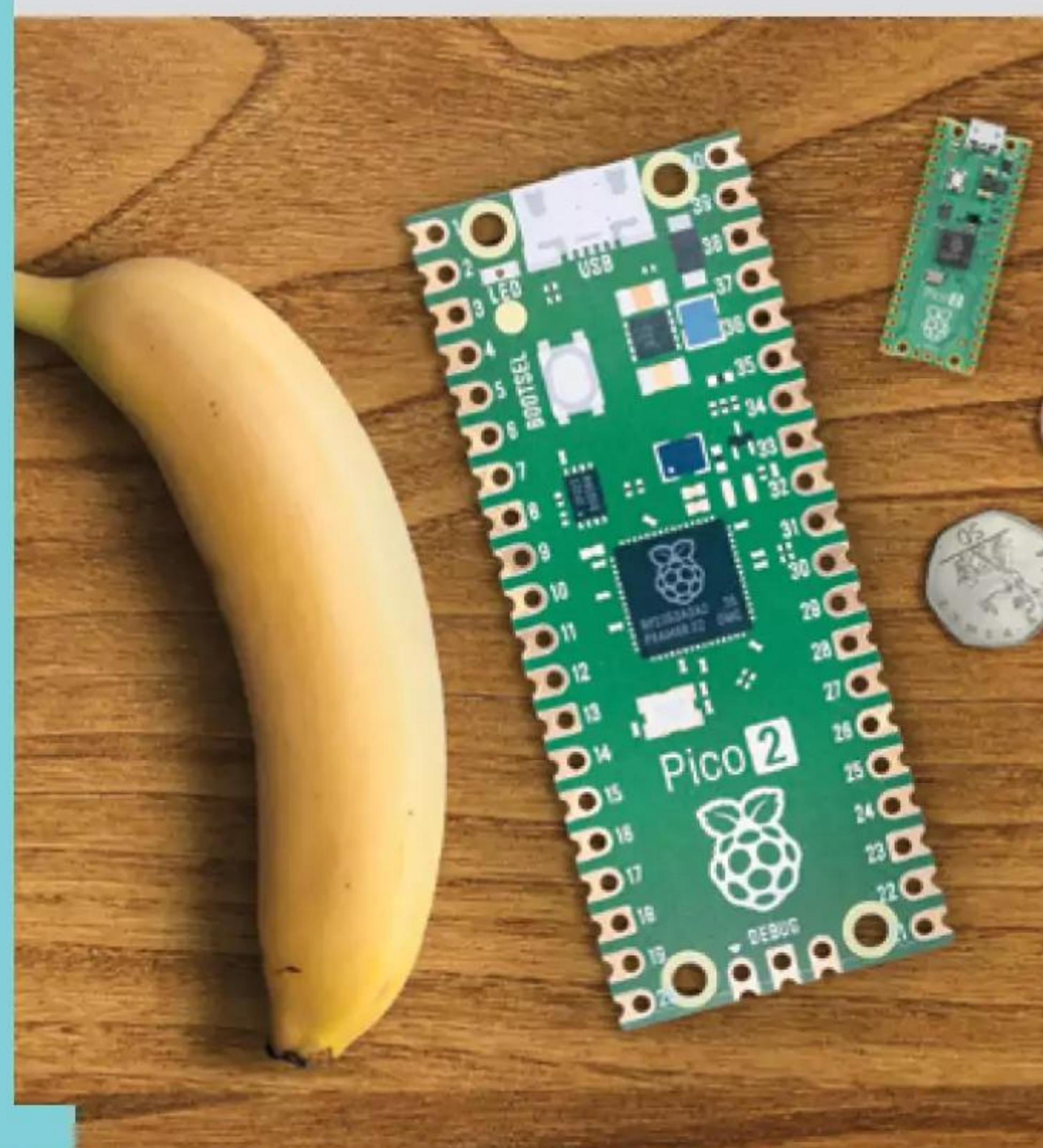

2nd Edition

Updated for
Raspberry Pi Pico W

Get started with MicroPython on Raspberry Pi Pico

The Official Raspberry Pi Pico Guide



Gareth Halfacree,
Ben Everard

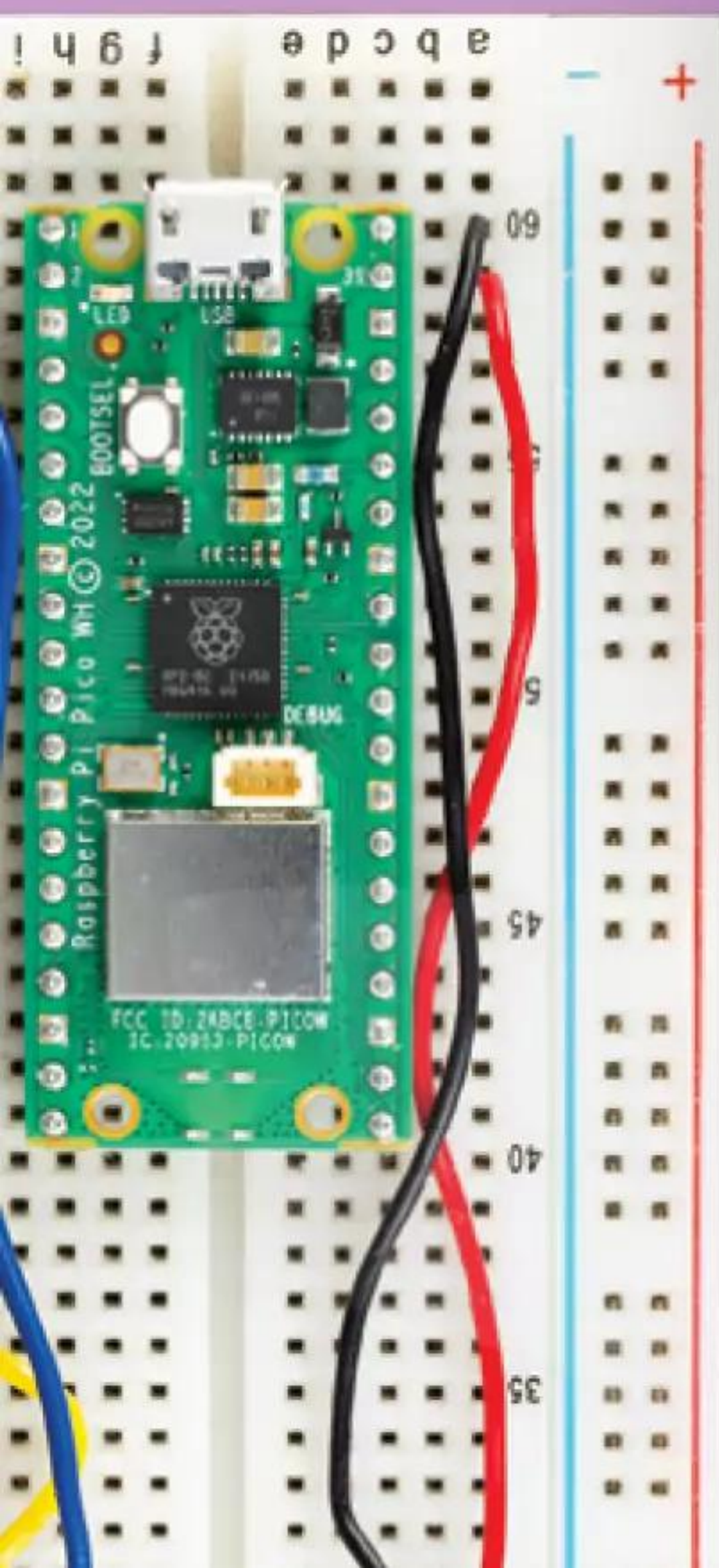

BUY ONLINE: magpi.cc/picobook

Gift a project

Give makers the present they really want – **something to build**

Sometimes the perfect gift doesn't exist. Sometimes that means you have to make it. Sometimes the person better suited to the job of making this perfect gift is the person who will receive it.

For makers, constructing their own gift can be very exciting. Normally it's just pre-packaged kit but giving them a big project to put together is even better. We thought we'd highlight a range of great projects for different interests that are also fun to build.

On a budget? We're breaking down the prices so that you can make a more informed decision too.

Let's get gifting. **M**

By gift elf
Rob Zwetsloot



Buyer's guide

Want a one-box gift? Check out our Gear Guide on page 38 for cool gifts for any skill level or age!

Gift a DIY games console



Making a handheld console can be as much fun as playing one

Apple Pocket Pi

link: magpi.cc/applepocketpi

tools required: 3D printer, soldering iron

This cool little handheld project features some great manual making and construction, with a custom PCB and 3D printed parts to play with. If your or the giftee don't have a 3D printer, you can always get it printed elsewhere however that may increase the budget a bit.

Software wise it's very simply, using RetroPie (retropie.org) for emulation which easily recognises the buttons via GPIO. The real meat comes in the manual construction, and user Chris Haynes has created a very comprehensive build guide for folks to follow on Instructables – which you can also print out as a PDF.

If you need to find game ROMs for the system, then you can get homebrew games from itch.io, and many classic game ROMs are sold legally online.



Warning! Legal ROMs

Please be cautious when finding ROMs for your retro setup that you are not downloading from a site hosting software illegally.

magpi.cc/legalroms

▼ The special Apple Pocket Pi board created by Chris Haynes for this project



Shopping List

<input type="checkbox"/>	Raspberry Pi Zero 2 W	£14 / \$15
<input type="checkbox"/>	MicroSD card	£10 / \$13
<input type="checkbox"/>	Waveshare 2.4" screen	£13 / \$17
<input type="checkbox"/>	Custom motherboard	£18 / \$23
<input type="checkbox"/>	USB-C breakout board	£3 / \$4
<input type="checkbox"/>	Oval speaker	£2 / \$3
<input type="checkbox"/>	PAM8302 amplifier	£4 / \$5
<input type="checkbox"/>	Powerboost 500C	£15 / \$19
<input type="checkbox"/>	Tactile buttons x12	£3 / \$4
<input type="checkbox"/>	B103 10k potentiometer wheel	£7 / \$9
<input type="checkbox"/>	SPDT slide switch	£6 / \$8
<input type="checkbox"/>	Breakaway pin headers	£4 / \$5
<input type="checkbox"/>	3000mAh 104060 LiPo battery	£9 / \$12

Total: £108 / \$137

Kit alternative

name: RetroFlag GPI Case

url: magpi.cc/gpicase

RetroFlag cases are easy to set up, with a lot less soldering and 3D-printing involved. You can get gaming in about 30 minutes.



Gift a DIY file server

A practical gift for the practical maker



How to build a Raspberry Pi NAS

link: magpi.cc/buildanas

tools required: None

Any serious maker or techie desires a centralised spot on their internal network where they can host all their files.

Then you can access them from any device – PC, tablet, smart phone, smart speaker, maybe even a smart watch if it’s set up correctly.

It also doesn’t need a huge number of components – in fact the biggest part of the project is the software setup, with a tutorial on the Raspberry Pi website detailing the various aspects of making sure the hard drive is connected, and how to make it visible on the network (link above). Linux doesn’t make it as easy as Windows to set up a network share, but it does give you greater control over how the storage is shared, and it works better.

Some hard drives are sold as NAS drives but they don’t make a huge amount of difference for home use



Shopping List

- Raspberry Pi 4 or 5 £43 / \$45
- Powered USB hub £20 / \$26
- Hard drive enclosure caddy £20 / \$26
- 4TB hard drive £80 / \$104

Total: £163 / \$201

Kit alternative

name: Argon EON

url: magpi.cc/argoneon

You’ll need to supply a few extra bits like a Raspberry Pi and hard drives, however this special case/enclosure is custom-made for all your NAS needs while also pushing the price of the overall project up.



Gift a DIY smart mirror

Mirror, mirror, on the wall, why are you not level

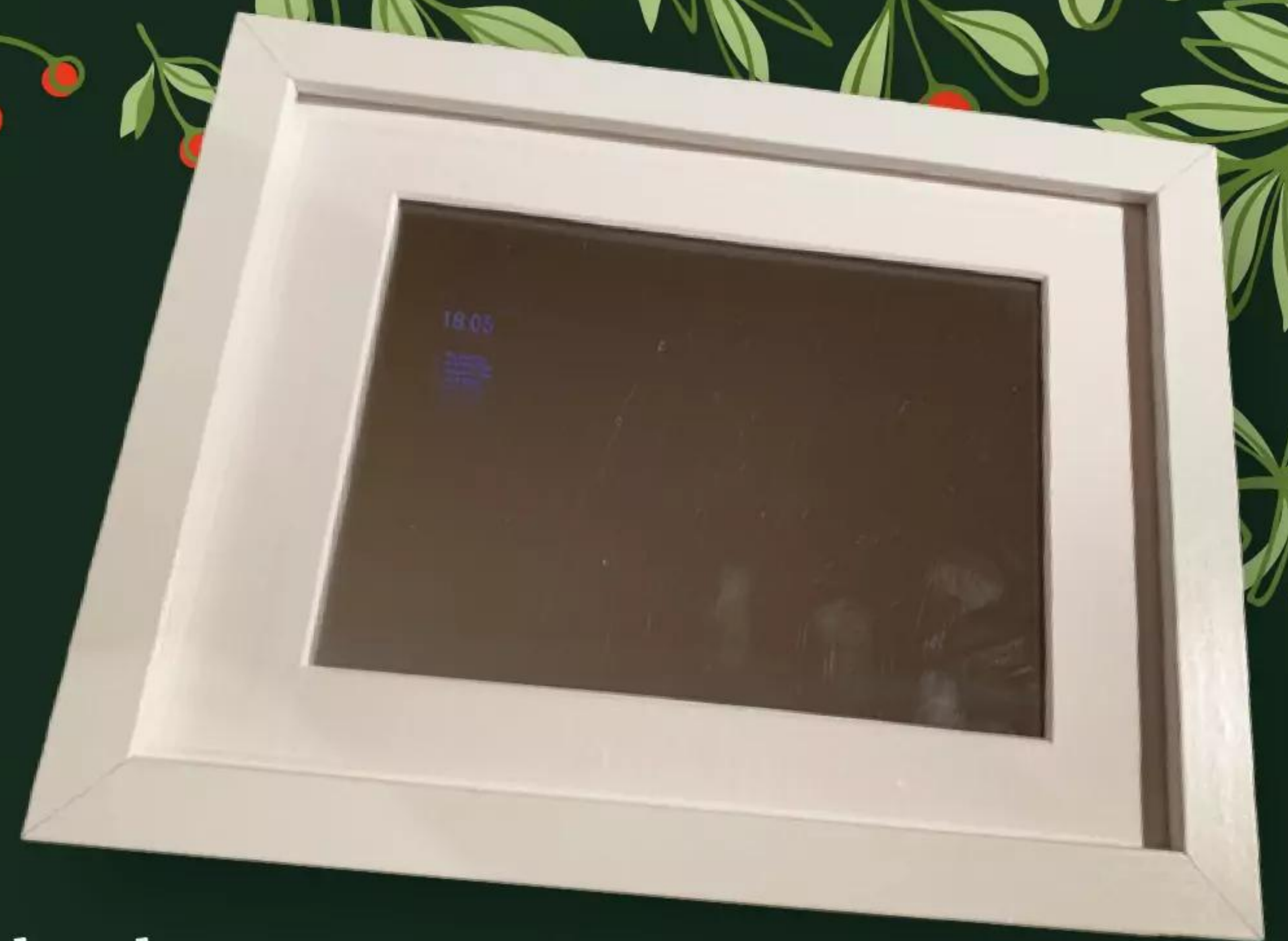

Magic Mirror

link: magpi.cc/90

tools required: Drill, for hanging (optional)

Smart mirrors are one of the quintessential Raspberry Pi projects, and they look very cool too. Working like a futuristic smart home, they hook into your calendar and weather data to let you find out about the day ahead as you get dressed. And as Features Ed Rob's mother always says: make sure to have a look in the mirror before you go out.

This particular version is a little smaller but also a little less involved than the traditional magic mirror, making use of an off-the-shelf picture frame to construct it. Unfortunately, the Ribba frame series from Ikea has been discontinued, although you can still find some on Amazon and eBay if you look. The Rödalm series (magpi.cc/rodalm) that replaced Ribba is a good alternative though.

For those who might want to build a full-size mirror, at a higher cost, you can check out the original magic mirror build in issue 54 of *The MagPi* (magpi.cc/54)

▼ The Ribba series is gone, but Rödalm is almost the same



Shopping List

- Raspberry Pi 4 or 5 £43 / \$45
- Ikea Ribba 18x24 picture frame £8 / \$10
- Official Raspberry Pi 7 Touchscreen £56 / \$60
- A5 observation mirror £9 / \$12
- Velcro or foam sticky pads £4 / \$5

Total: £120 / \$132

▼ The depth of the Ikea frames allows you to put electronics behind them quite easily



Gift a DIY camera

Point and shoot with a preview screen



Touch Cam

link: magpi.cc/touchcam

tools required: 3D printer, soldering iron

There are fewer full-body Raspberry Pi camera projects out there than you'd think, especially when it comes to a traditional camera using the excellent Raspberry Pi HQ Camera Module. This very elegant design allows you to build a portable point-and-shoot camera with a preview screen, rechargeable battery, and even a tripod adapter.

Maker Mukesh Sankhla goes into detail on how he designed the case on the Instructables page, giving an insight into the 3D-print design process that may be useful for future projects.

The use of the HQ Camera allows for multiple lenses, and the touchscreen allows you to edit camera settings such as ISO, exposure and more, thanks to a graphical interface.

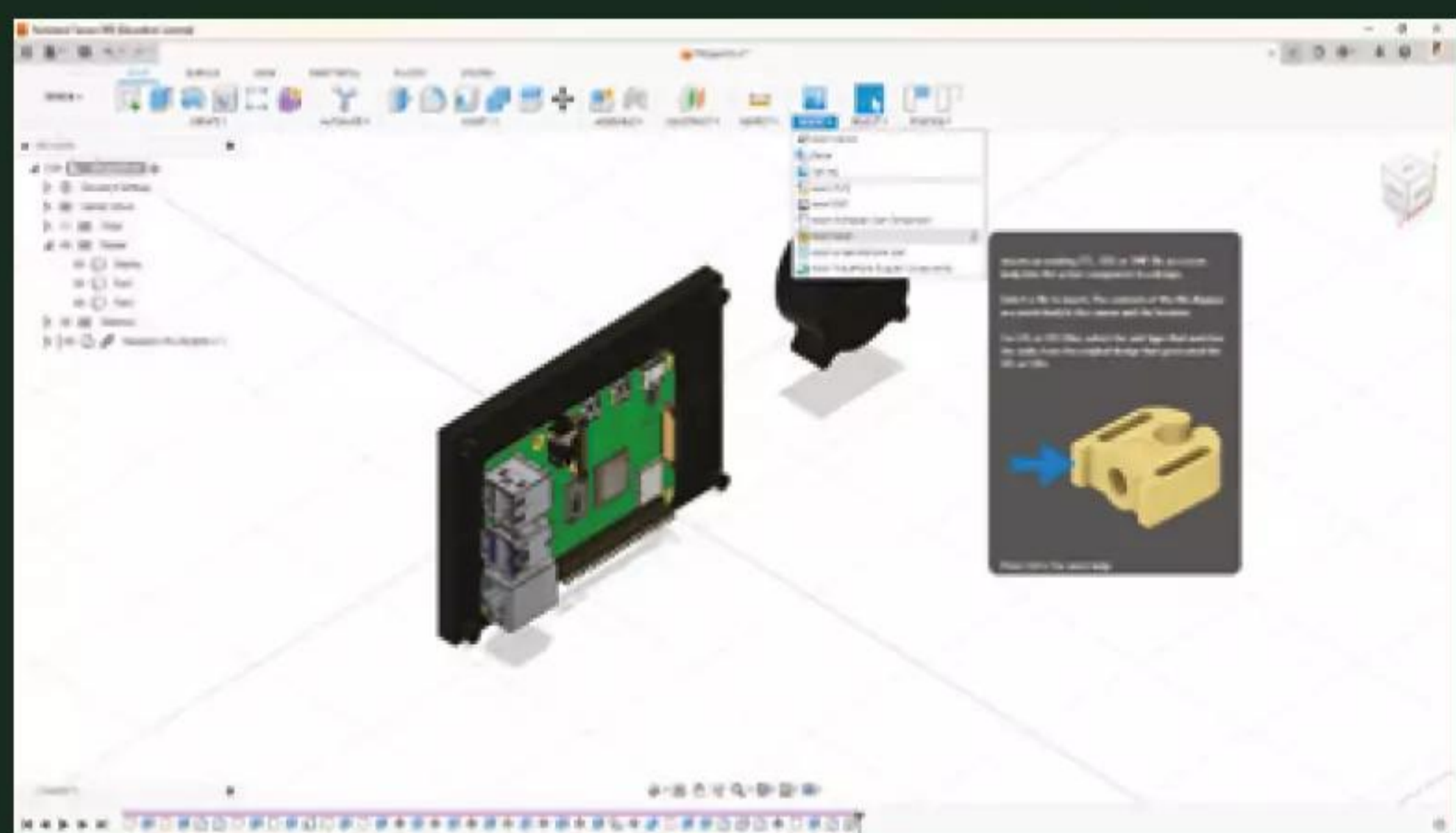

▲ We appreciate the explanation of how everything was designed – it's a great peek into CAD

Shopping List

- | | |
|---|------------|
| <input type="checkbox"/> Raspberry Pi 4 or 5 | £43 / \$45 |
| <input type="checkbox"/> DFRobot Raspberry Pi Touch Display | £35 / \$45 |
| <input type="checkbox"/> Raspberry Pi HQ Camera Module | £48 / \$50 |
| <input type="checkbox"/> 16mm Lens or 6mm Lens | £39 / \$50 |
| <input type="checkbox"/> Touch Sensor | £5 / \$6 |
| <input type="checkbox"/> 5V 4020 Fan | £10 / \$13 |
| <input type="checkbox"/> Raspberry Pi heatsink kit | £4 / \$5 |

Total: £184 / \$214

▼ A modest selection of parts to get the job done



Gift a DIY robot

A low-cost automaton for the robot lover



Burgerbot V2

link: magpi.cc/burgbotv2

tools required: 3D printer

Kev's low-cost Pico-powered robot is very compact and extremely functional. Version two lets it work like a turtle of old with a marker pen inserted inside, and you can even access it remotely thanks to its wireless capabilities.

It uses a lot of off-the-shelf robot parts that are not only fairly cheap, but universal. They can always be used in future robot projects, and the Burgerbot itself is easily upgradeable.

Many of the parts are 3D-printed, and they're designed in such a way that everything slots or screws in, so there are no cutting, sticking, or soldering tools required to build it. Especially useful if the maker in mind to receive this gift is a bit younger than most.

▼ The original Burgerbot had a Pico resting on top, which had the effect of making it easily accessible



Shopping List

<input type="checkbox"/> Raspberry Pi Pico	£6 / \$6
<input type="checkbox"/> Ultrasonic Range Finder	£7 / £9
<input type="checkbox"/> Motor SHIM for Pico	£10 / \$13
<input type="checkbox"/> LiPo SHIM for Pico	£8 / \$10
<input type="checkbox"/> Micro Metal Motors	£5 / \$6
<input type="checkbox"/> Moon Buggy Tyres	£5 / £6
<input type="checkbox"/> Galleon Battery	£8 / \$10
<input type="checkbox"/> SG90 Servo	£2 / \$3

Total: £51 / \$63

Kit alternative

name: CamJam Edu3 Kit 3

url: magpi.cc/camjamedu3

This classic and very cheap kit is a great way to get someone into robotics. You can 3D-print a casing or just use the box as a chassis for it to run around.

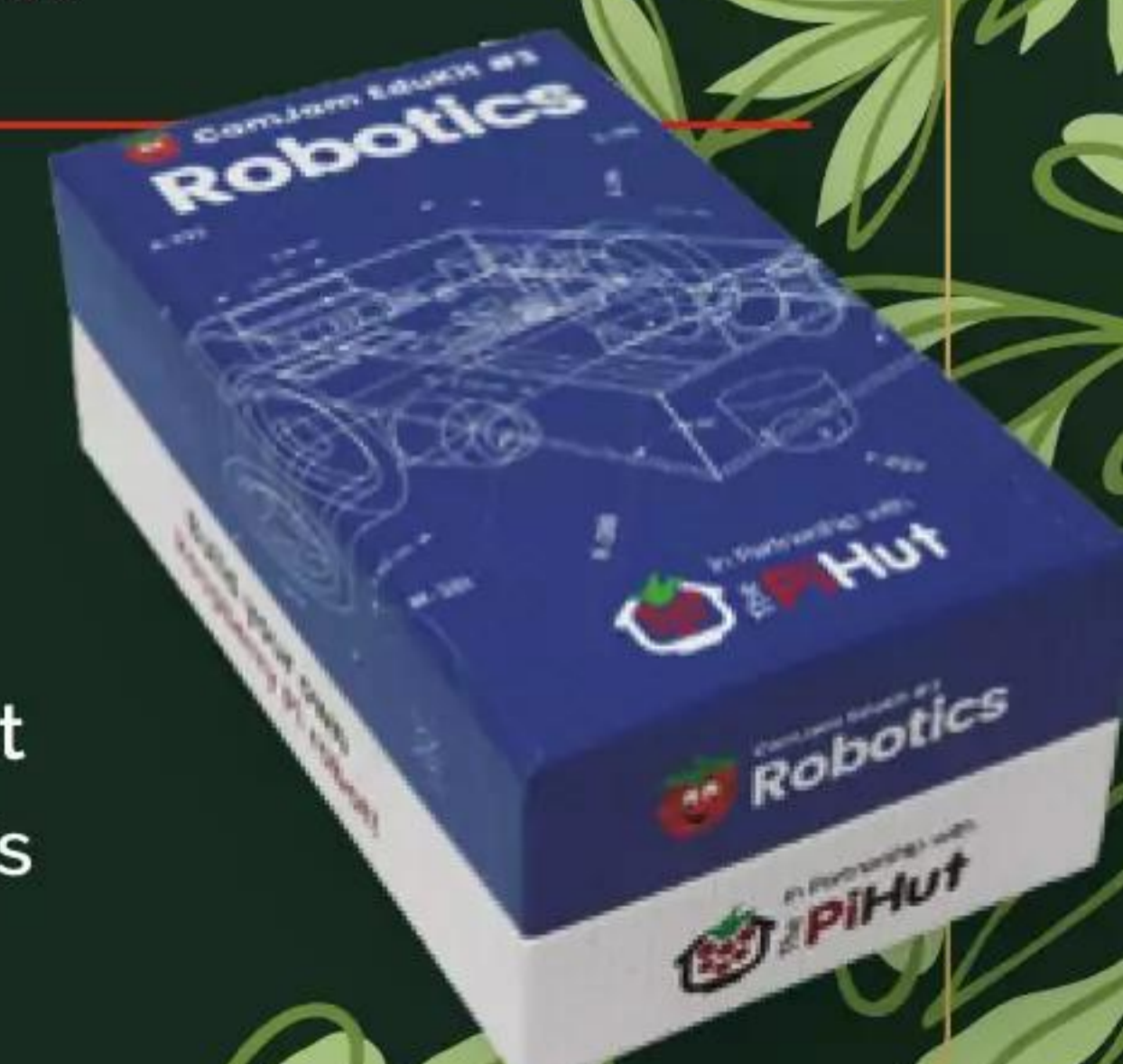

PiDog

► SunFounder ► magpi.cc/pidog ► £157 / \$180

A smart robotic dog packed with features and possibilities. By **Phil King**

SPECS

FEATURES:

12 × metal-gear servos, Robot HAT, camera module, RGB LED strip

SENSORS:

Sound direction, 6-DOF IMU, dual touch, ultrasonic distance

WORKS WITH:

Raspberry Pi 4, 3B+, 3B, Zero 2 W

POWER:

USC-C, rechargeable 2×18650 battery pack

Powered by a Raspberry Pi (not included) and featuring 12 servos, PiDog is a metal marvel that can do (almost) anything a real dog can do. Walk, sit, lie down, doze, bark, howl, pant, scratch, shake a paw...

Equipped with a bunch of sensors, it can self-balance, discern the direction of sounds, detect obstacles, and see where it's going. You can even get a dog's-eye view from its nose-mounted camera via a web page or companion app.

The first thing to decide is which Raspberry Pi model to use before assembling the kit. PiDog will work with Raspberry Pi 4, 3B+, 3B, and Zero 2 W. Using a Raspberry Pi 5 is not recommended since its extra power requirements put too much of a strain on the battery power – PiDog uses a lot of current when standing or moving – so it's likely to suffer from under-voltage. We opted for a Raspberry Pi 4, although even then we did have a few issues with crashes when the battery level was low.

Canine construction

With a kit comprising a huge array of parts, building a PiDog is no mean feat. We reckon it took us around five to six hours, although we were taking our time to get it right. The printed diagram-based instructions are easy to follow, however, and there are online videos if you get stuck. Apart from a few fiddly bits, including manipulating some tiny screws and nuts, it's an enjoyable process. Helpfully, the fixtures and fittings

– including numerous sizes of screws and plastic rivets – come in labelled bags. The kit includes a couple of screwdrivers too.

The main chassis is built from aluminium alloy panels, giving this dog a shiny and robust 'coat'. There are also several acrylic pieces, including some to build a stand to place PiDog on when calibrating its leg servos. A nice touch.

Raspberry Pi sits on a sound direction sensor module and is then mounted with a Robot HAT which handles all the servos (via PWM pins), sensor inputs, and battery management. Portable

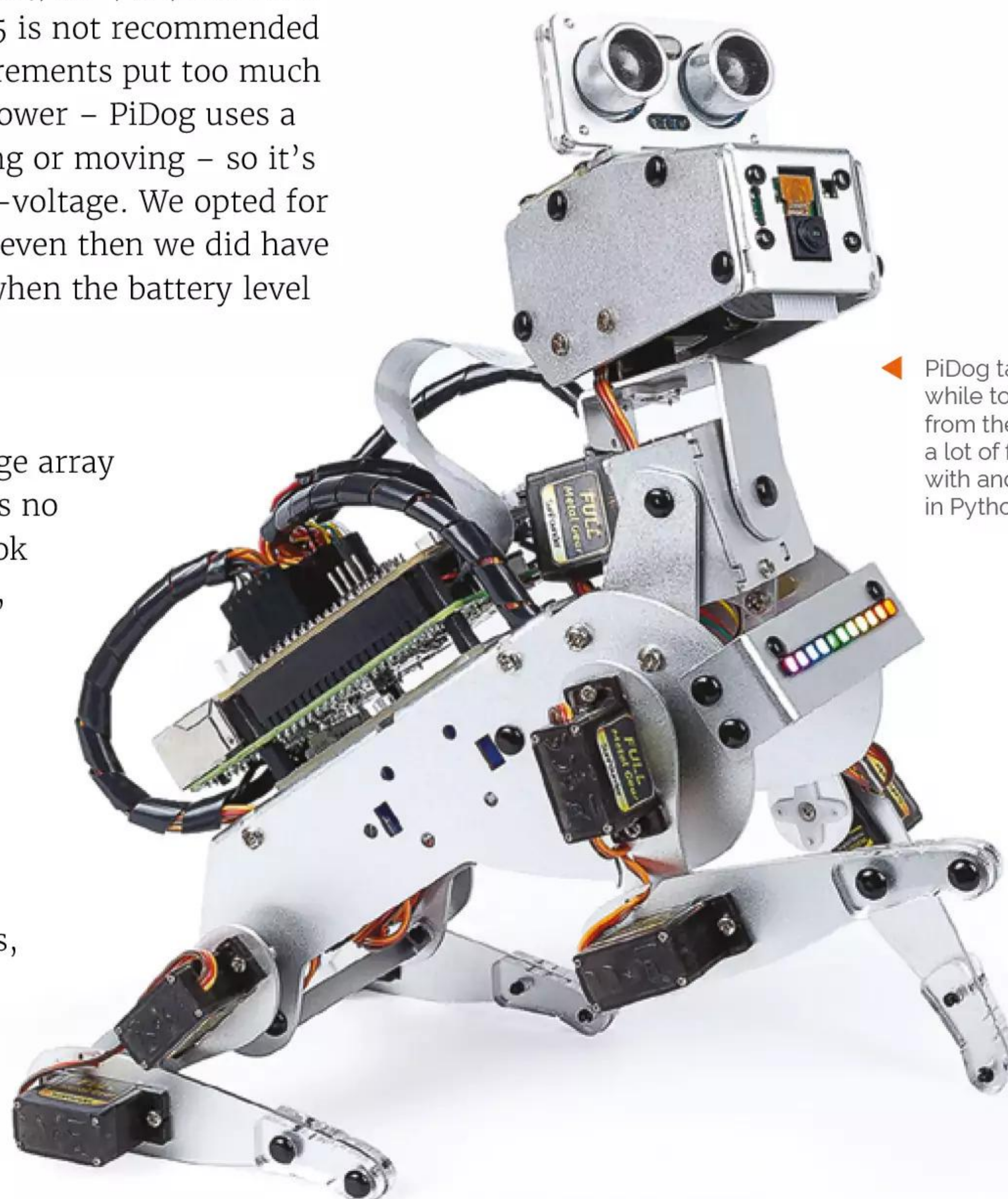

◀ PiDog takes a while to build from the kit, but is a lot of fun to play with and program in Python

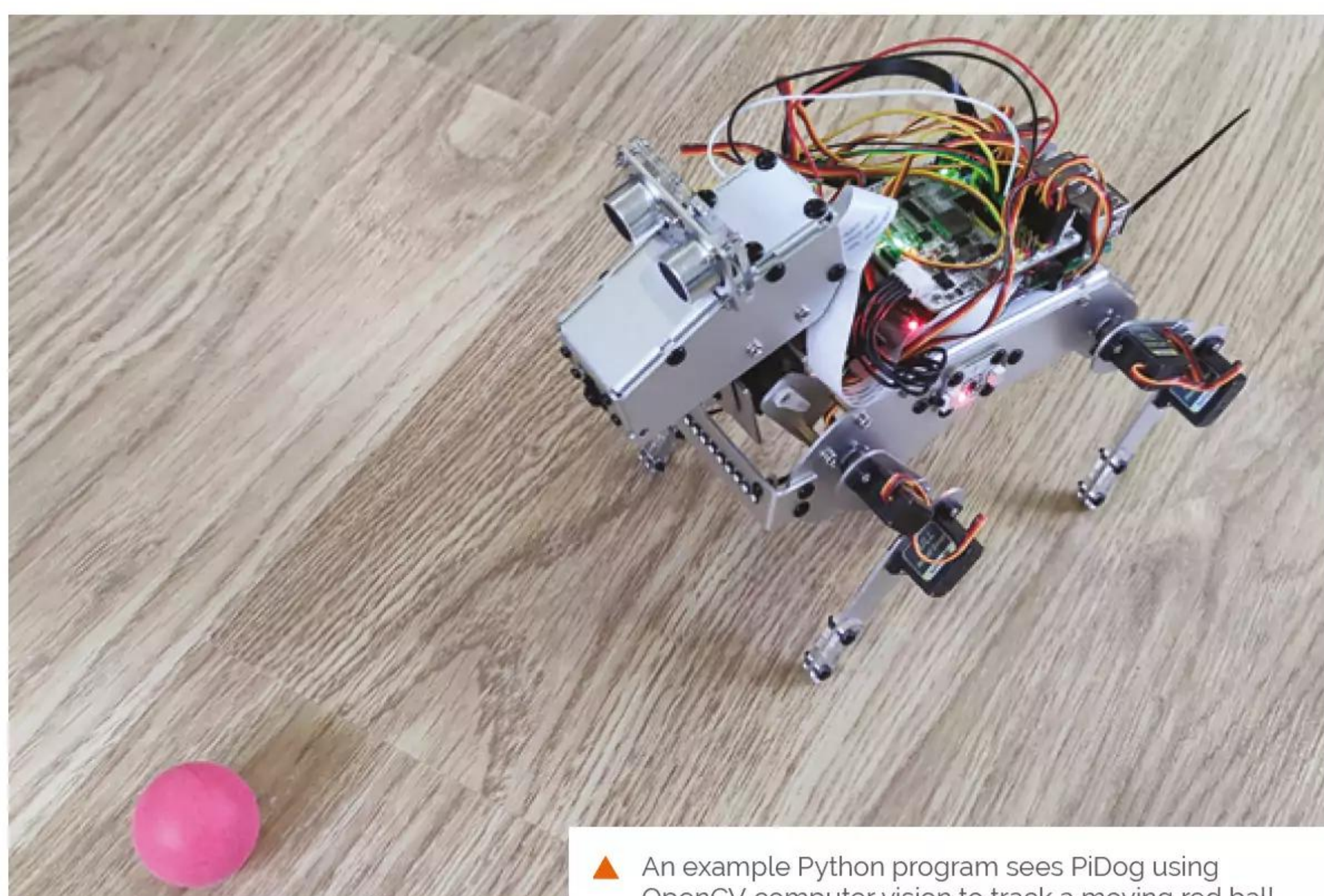

▲ An example Python program sees PiDog using OpenCV computer vision to track a moving red ball

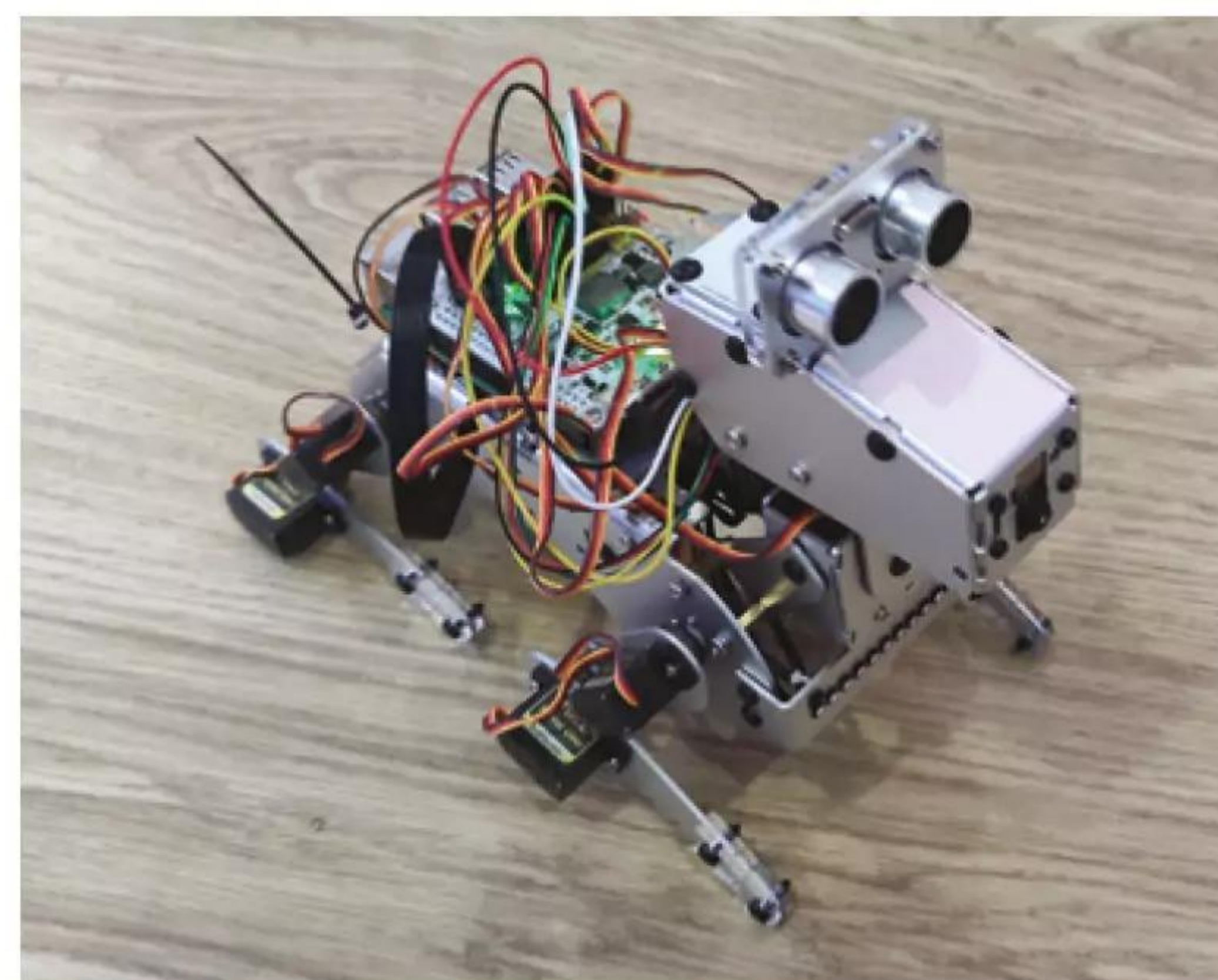

▲ You'll end up with spaghetti wiring into the Robot HAT, but can use the supplied spiral binding to tidy it up a bit

power is supplied by a custom battery pack comprising two 18650 batteries with a capacity of 2000mAh, which takes a couple of hours to charge fully.

Doggy-do code

Once you've assembled the kit, it's time to fine-tune the calibration of the servos with a script. You'll have used a zeroing script during assembly to get the rough positions right, so will have already installed the PiDog libraries and software in Raspberry Pi OS.

Detailed online documentation guides you through everything, including running a script to enable I2S sound from the robot's speaker. It also covers a good range of Python example programs that showcase what PiDog can do.

In patrol mode, for instance, PiDog walks forward and stops to bark when it detects something ahead. The react demo sees it rear up and bark when approached from the front, but roll its head and wag its tail when you pet the touch

sensor on its neck. There's also a balance demo to showcase its 6DOF IMU module that enables PiDog to self-balance when walking on a tilting tabletop.

There are a few examples using the camera module with OpenCV computer vision. A face-tracking demo generates a web server, enabling

“ You can even communicate with your PiDog via GPT-4o AI, using text or spoken commands ”

you to see the camera view on a web page. There's also the option to control PiDog with an iOS or Android app, complete with live camera feed.

You can even communicate with your PiDog via GPT-4o AI, using text or spoken commands – with a USB mic (not supplied) equipped. It takes a bit of setting up, using an API key, but the online guide takes you through the process. **M**

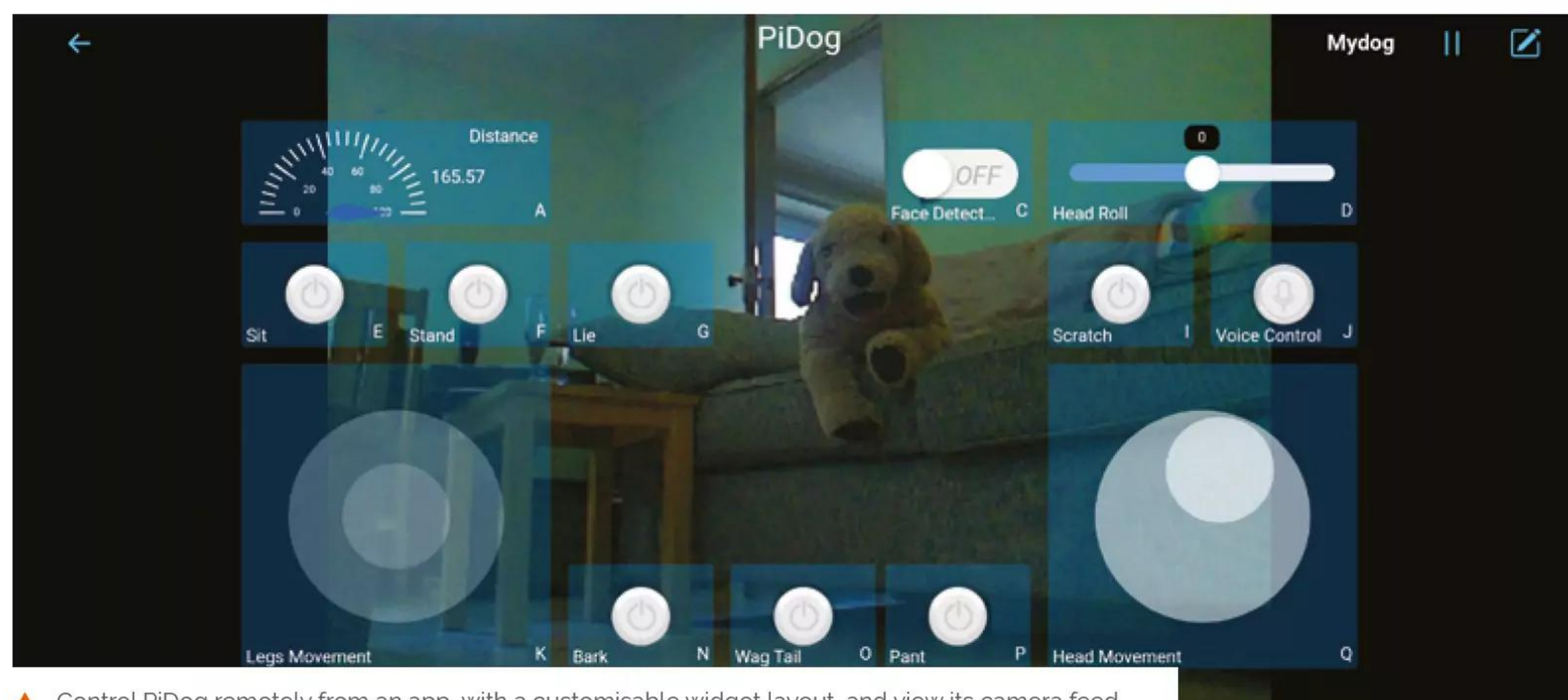

▲ Control PiDog remotely from an app, with a customisable widget layout, and view its camera feed

Verdict

Great fun to play with, this smart canine companion has an impressive feature set and lots of possibilities for further training.

9/10

Waveshare PCIe USB 3.2 Gen 1 HAT+

► The Pi Hut ► magpi.cc/pciusbhat ► £19 / \$21

For when you need more USB ports on Raspberry Pi 5.

By **Phil King**

SPECS

FEATURES:

4 × USB 3.2 ports, USB-C power port, GPIO extender, PCIe cable, standoffs and screws

USB PORTS:

Up to 4Gbps shared, 2.6A total (without extra PSU)

Waveshare's PCIe USB 3.2 Gen 1 HAT+ adds four extra USB 3.2 Gen 1 ports to Raspberry Pi 5 via the latter's high-speed PCIe port.

So, as well as not tying up an existing USB port, as a standard USB hub would, it's not limited to the bandwidth of that single port.

Assembly is as simple as connecting the supplied 40mm flexible ribbon cable between the HAT+ and Raspberry Pi 5's PCIe port, making sure it's oriented correctly. You can then secure the board on top with the supplied screws and standoffs.

A square cutout in the PCB aids ventilation, and can be used with the Active Cooler. Another cutout offers easy access to the Camera/Display ports. The GPIO header is extended so you can stack another HAT on top.

Speed and power

To enable the HAT+, you just need to enable PCIe (if not already done) in the config.txt file in Raspberry Pi OS. While you can also enable PCIe Gen 3 there, the HAT+ is limited to Gen 2 speeds. Even so, the latter offers up to 4Gbps to share between the ports – exact speeds will vary greatly depending upon the device connected.

While the ports are limited to 2A of current each (from a total of 2.6A), this can be boosted via the board's USB-C power port. An on-board INA219 chip enables each port's power to be turned on and off, too – for advanced users, GPIO control is possible by soldering four SMT resistors on the PCB. **M**

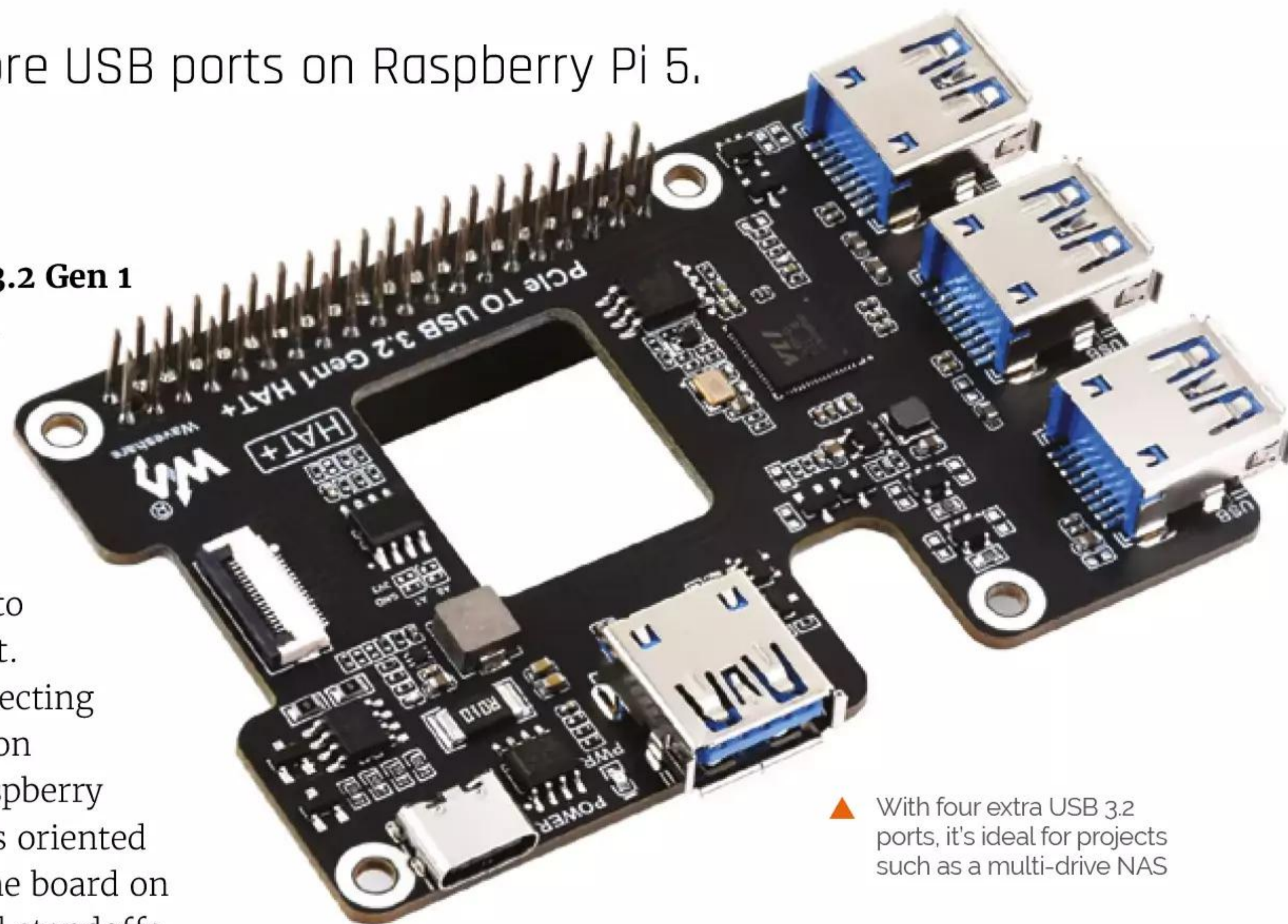

▲ With four extra USB 3.2 ports, it's ideal for projects such as a multi-drive NAS

“ An on-board INA219 chip enables each port's power to be turned on and off ”

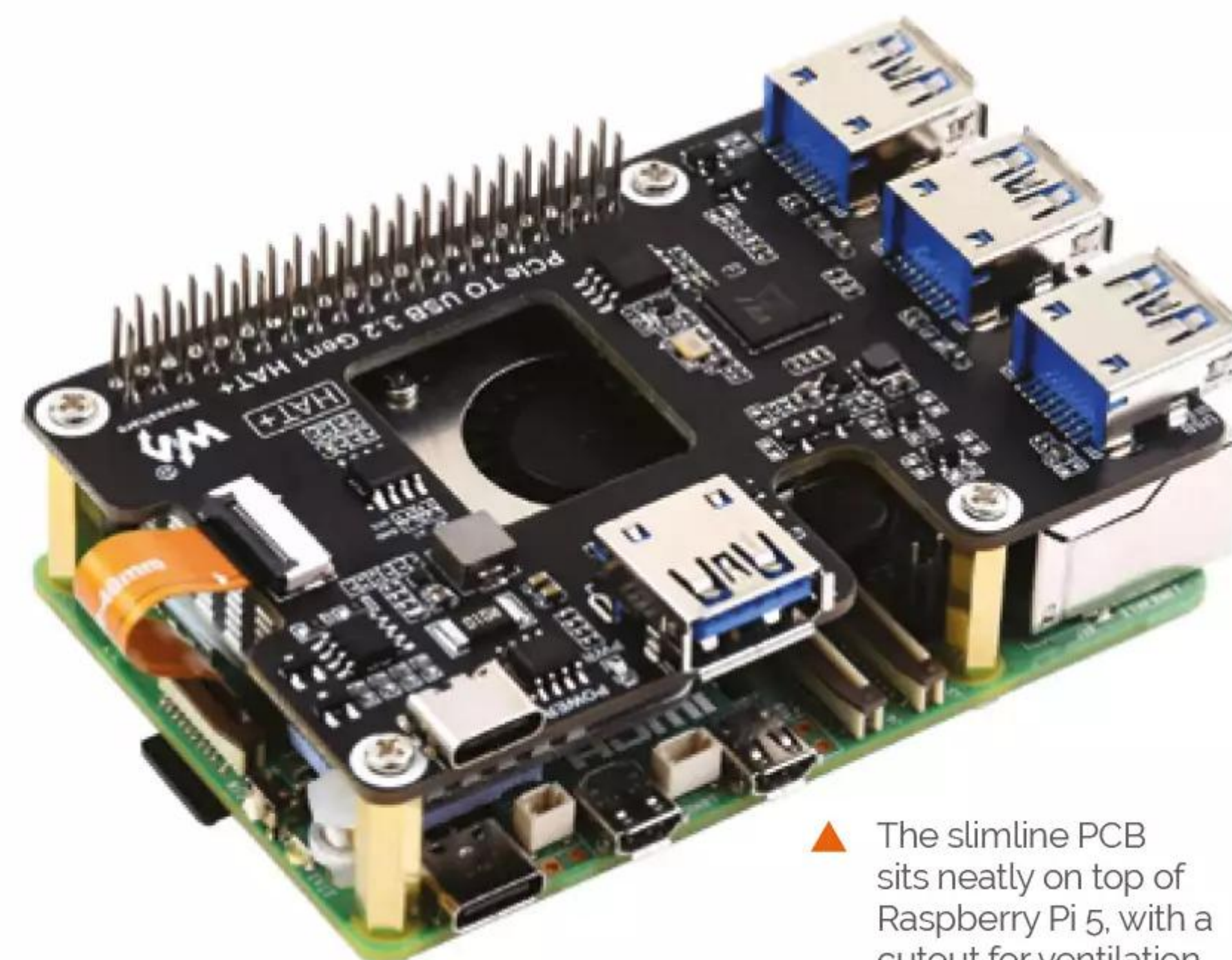

▲ The slimline PCB sits neatly on top of Raspberry Pi 5, with a cutout for ventilation

Verdict

A neat way to add extra, fast USB ports, although it does tie up the PCIe port.

8/10



- *Get game design tips and tricks from the masters*
- *Download and play game examples inspired by classics*
- *Learn how to code your own games with Pygame Zero*
- *Explore the code listings and find out how they work*

Code the Classics Volume II not only tells the stories of some of the seminal videogames of the 1980s, but shows you how to create your own games inspired by them using Python and Pygame Zero, following examples co-programmed by Andrew Gillet and Raspberry Pi founder Eben Upton.

Available now: magpi.cc/store

UPi B7 - Raspberry Pi Case With Touchscreen

► UPERFECT ► hsmag.cc/UPiB7 ► \$169.99 (approx £130)

An affordable touchscreen device for your grubby little fingers.

By **Andrew Gregory**

SPECS

DISPLAY:

Capacitive touch, 10.1-inch, 1920×1200, IPS, 60Hz refresh rate

CONNECTIONS:

Power, full-size HDMI, USB-C

The UPi B7 from Uperfect is a case, a touchscreen and a power supply all in one. It's compatible with Raspberry Pi 3B+ and Raspberry Pi 4, and because of this there are slightly different ways of connecting it all up that mean there are components in the box that you won't use, depending on whether you're using it with a 3B+ or a 4.

In the box there's the device itself, which features a crisp 10.1-inch screen, the electronics to enable you to plug your Raspberry Pi in, including a power supply, a built-in fan, and a pair of 8-ohm, 1W speakers. There are also a few tiny PCBs that join the HDMI and Micro USB ports of the Raspberry Pi to pins on the device, and two plastic panels that correspond to the USB port layout of either a model 3B+ or a Raspberry Pi 4. We tested the UPs B7 using a Raspberry Pi 4.

There are two ways of connecting a Raspberry Pi to the touchscreen: the first and most complicated is to solder three points of a wire

to the three test points (TP 18, 19 and 20) on the back of the Raspberry Pi. These aren't through-hole soldering locations, so you'll have to be confident that you can attach the wires with a small amount of solder so as not to short the connections, and do so without damaging the rest of the board. The second option is to use one of the enclosed cables from one of the Raspberry Pi's USB ports back through a small hole in the case, and clip it into the circuit board on the device. For testing purposes we went for this option, and it worked, but it does



► The IPS screen has a nice sharp resolution

▼ Raspberry Pi model 3B+ or 4 are supported, with all the parts you need for both Raspberry Pi boards included in the box



mean that if you're going to use the touchscreen functionality then you'll have to give up one of the USB ports on your Raspberry Pi.

The Uperfect UPi B7 had us baffled at first. It's a touchscreen, with a boxy rectangle on the back into which you slot your Raspberry Pi. The first comparison we make when presented with a portable touchscreen is a tablet, such as an iPad. It's very much not one of these, as it's bulkier, and it needs to be plugged in to a mains power source, which limits how well you can use it when you're lounging on the sofa looking up actors on **imdb.com**.

Where this device really shines is when it's hooked up to a larger monitor. Raspberry Pi OS is made to be used with a mouse and keyboard, and so using it on a 10-inch touchscreen can feel



▼ Raspberry Pi's inputs remain accessible

imprecise. But when you use the touchscreen as an input device for a larger monitor, it feels so much more natural. We found ourselves working on our large monitor and not even looking at the touchscreen as we were using it – it really does feel natural. With the touchscreen flat on our desk it worked as a useful replacement for a mouse – more creative types than us could use it instead

“ A bargain alternative to the mouse-screen-keyboard combination ”

of a graphics tablet. And while we wouldn't want to use it to type for long periods it's good enough for quick data input, which opens up a range of possibilities in industry – say, keeping track of orders in a restaurant, or connected over a network to an inventory system where a full-size keyboard would attract dirt.

We've seen this model on sale for just over £100, which makes it a bargain if you're looking for an alternative to the mouse-screen-keyboard combination that has been keeping posture experts in work since it was unleashed on to the world in 1968. You may want to make some adjustments to the icon sizes in the default Raspberry Pi OS display to make them more touch-friendly, and we wouldn't recommend this to anyone who wants a tablet. But as a device that, with a little tweaking, can unlock extra input options, and breathe new life into a Raspberry Pi 4 or even a 3B+, we'll give it a thumbs up. **M**

▲ You can either solder the cable that provides touchscreen functionality, or take the easy way out at the expense of a USB port, like we did

▼ You get all the cables you need to connect the device to an additional monitor



Verdict

Unlocks extra input options for Raspberry Pi 3B+ and 4

8/10

Argon Poly+ 5

▶ Argon 40 ▶ argon40.com ▶ £6

Argon's latest offering bucks the high-end trend and goes back to basics. **PJ Evans** gets on the case

SPECS

FORM FACTOR:

Raspberry Pi 5 plus fan or HAT

ASSEMBLY:
Snap-together

MATERIAL:
ABS Plastic

Since the first appearance of the original Raspberry Pi, there have been Raspberry Pi cases in all shapes, sizes and colours.

The first were often improvised affairs, including carefully cut acetate sheets and a model treasure chest from a hobbyist shop. Soon, we were deluged with options and the standard has only risen.

Today there is a multitude of choices, but it is Argon40 that has cornered the high end of the market. Argon's recent ONE, NEO and EON range represent great design, rock-solid build and quality finish. Something you will always be happy to have on display. That might be about to change with the Argon Poly+ 5.

Argon has decided that owning the top end of the market is not enough and, has launched its first budget case, the Poly+ 5. Will Argon's high standards translate to a lower-end product? We were keen to see.

The Poly+ 5 is a Raspberry Pi 5 case in two flavours and colours. The case itself is moulded plastic with none of the aluminium work we've

come to expect. The slightly transparent slidable top cover is available in red or black with a black base in both cases. The standard model comes with a 30mm PWM fan and an array of heatsinks. For a few more pounds you can opt for the mightier THRML-30 unit if you're going to be running things hot. This is a similar unit to the official cooler with a fan and a large heatsink in one. If you forgo the fan you can fit a standard HAT in the case too (albeit one without any protrusions).

Assembling the case is straightforward. Attach the fan to the cover, pop on the heatsinks and clip everything together. It took no more than a few minutes. This is a clip-together screwless case (with the exception of the fan). The fan connects to the new fan header, so you get active, responsive cooling, just like the official equivalent.

In that case

In terms of usage: well, it's a case and it does that job well. At no point did the Raspberry Pi leap out and do a runner, so we'll call that a win. The

▶ The Argon Poly+ 5 comes in two colour options for the sliding 'hood'





▲ Having the power button highlighted in orange is a nice touch for the case

“ At no point did the Raspberry Pi leap out and do a runner ”



▲ Need more aggressive cooling? This powerful unit is available as an option

fan was whisper-quiet throughout. There are no impediments to port access with the exception of the GPIO, which is fully covered. A thoughtful touch is the addition of a power button in a striking orange on the exterior, and next to that, unusually for a budget case, is a cover for the SD card (although this cannot be secured as with the NEO case). The base features ventilation slats to ensure good air movement from the fan. It stands on four rubber feet (also supplied).



◀ Need more aggressive cooling? This powerful unit is available as an option

Argon is trying to bring its design ethos to the budget market, and does it succeed? It's certainly pleasing to look at, although lacking the sleek lines of the ONE or the elegant curvature of the official cases. What it does have in spades is value for money. At just £6 this is a great choice if you just need a protective, cooling case and nothing more. *M*

Verdict

It's a case. No fancy features, no extravagant design, no fancy lights. It is something that will protect and cool your Raspberry Pi well and at a fantastic price. If that's what you need, look no further.

8/10

10 Amazing: Raspberry Pi festive light projects

Light up your home this holiday season with a little help from Raspberry Pi

Whether you celebrate Christmas, Yule, Hannukah, Festivus, or anything else during December, there's plenty of ways to decorate your home this festive season. We've got a selection of ten amazing light projects to help inspire you along the way. 



▲ Raspberry Pi Fireplace Emulator

No chestnut roasting

Unable to build a real fireplace, maker Peinador decided to make their own out of a Raspberry Pi and an LED matrix. It's not as warm but it's just as festive.

magpi.cc/fireplace



▲ NeoPixel Menorah

No oil needed

Celebrate the nights of Hannukah without needing candles permanently lit in your home. Just press the button to light the next candle each night.

magpi.cc/neomenorah



◀ Christmas Tree Lights 1

Simple NeoPixel tree

The simplest way to create Christmas tree lights with Raspberry Pi – and it even makes use of Node-RED for the code block enjoyers.

magpi.cc/treelights1

▼ Johnson Family Christmas Light Show

Garden display

This very custom lightshow changed many times over the years but always lit up in sync with the music, and you could listen in on your radio.

magpi.cc/johnsonlights





▲ Holiday Light Show

House display

A slightly simpler but no-less spectacular way of creating a music-synced light show for your home – it uses very few components too.

magpi.cc/holidaylightshow



◀ Christmas Tree Lights 2

Festive Energenie automation

Automating your Raspberry Pi-powered Christmas tree lights couldn't be easier with an Energenie and Pi-mote, as Stewart Watkiss shows us.

magpi.cc/treelights2

▼ Cheap LED display matrix

Lights on a budget

From a distance you don't need a dense concentration of LEDs – with just 96 you can create excellent festive matrix that can display colourful low-res animations.

magpi.cc/cheapled

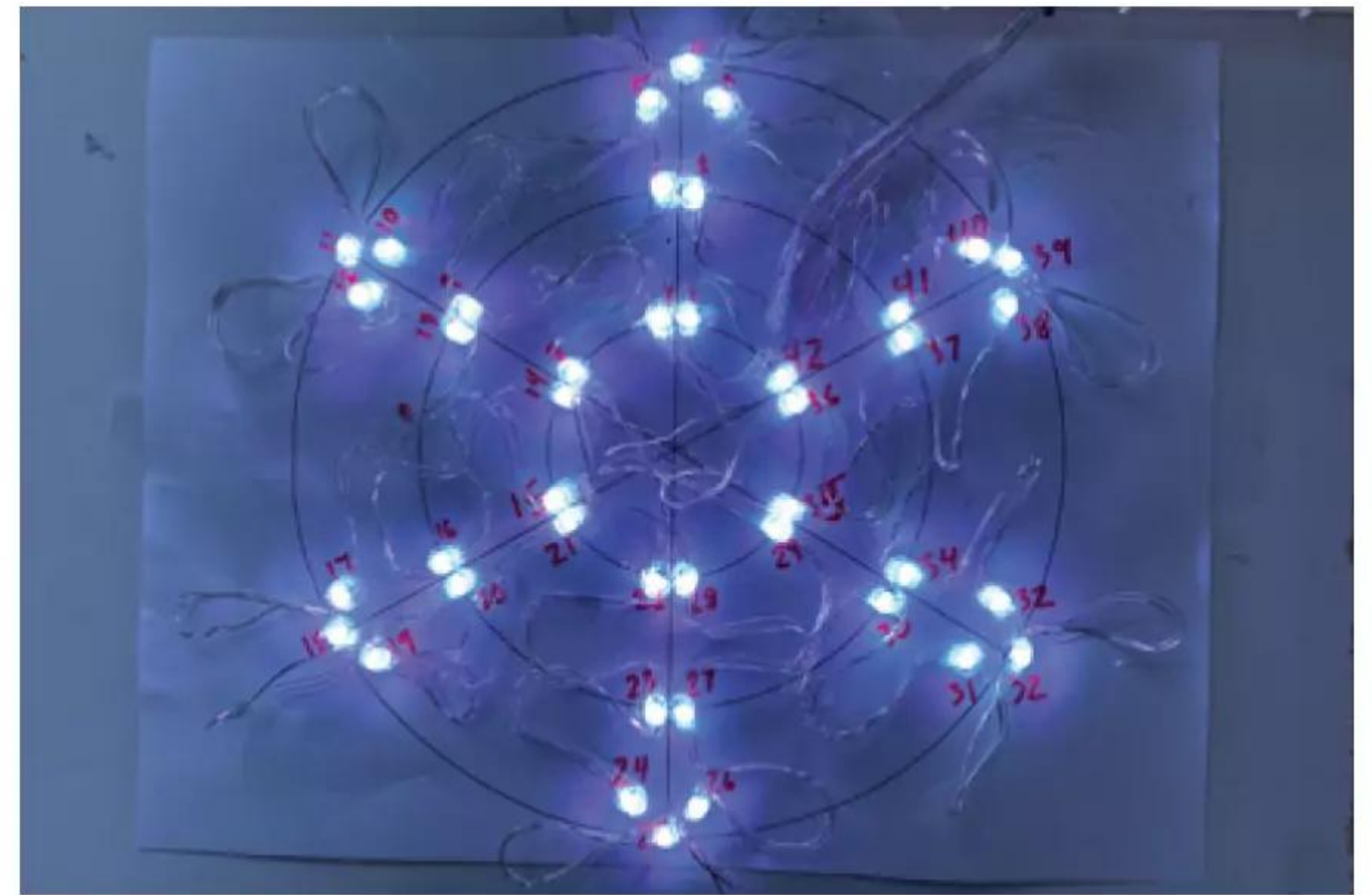

▲ LED snowflake

Non-denominational decoration

This simple project from Codeacademy is mostly code and a lot of LEDs, but it's a cool decoration to put behind a window.

magpi.cc/ledsnowflake



▲ Audio Reactive Holiday Lights

Fa-lah-lah-LED

Having your lights react to your Christmas songs is a great way to make the festive atmosphere much more immersive.

magpi.cc/audiolights

▶ Christmas Tree Lights 3

Tree light show

This tree light show goes the extra step and has lights that flash to the music. Be extra careful if you attempt this build though – it uses relays and mains power. We suggest integrating the code into a similar project.

magpi.cc/treelights3

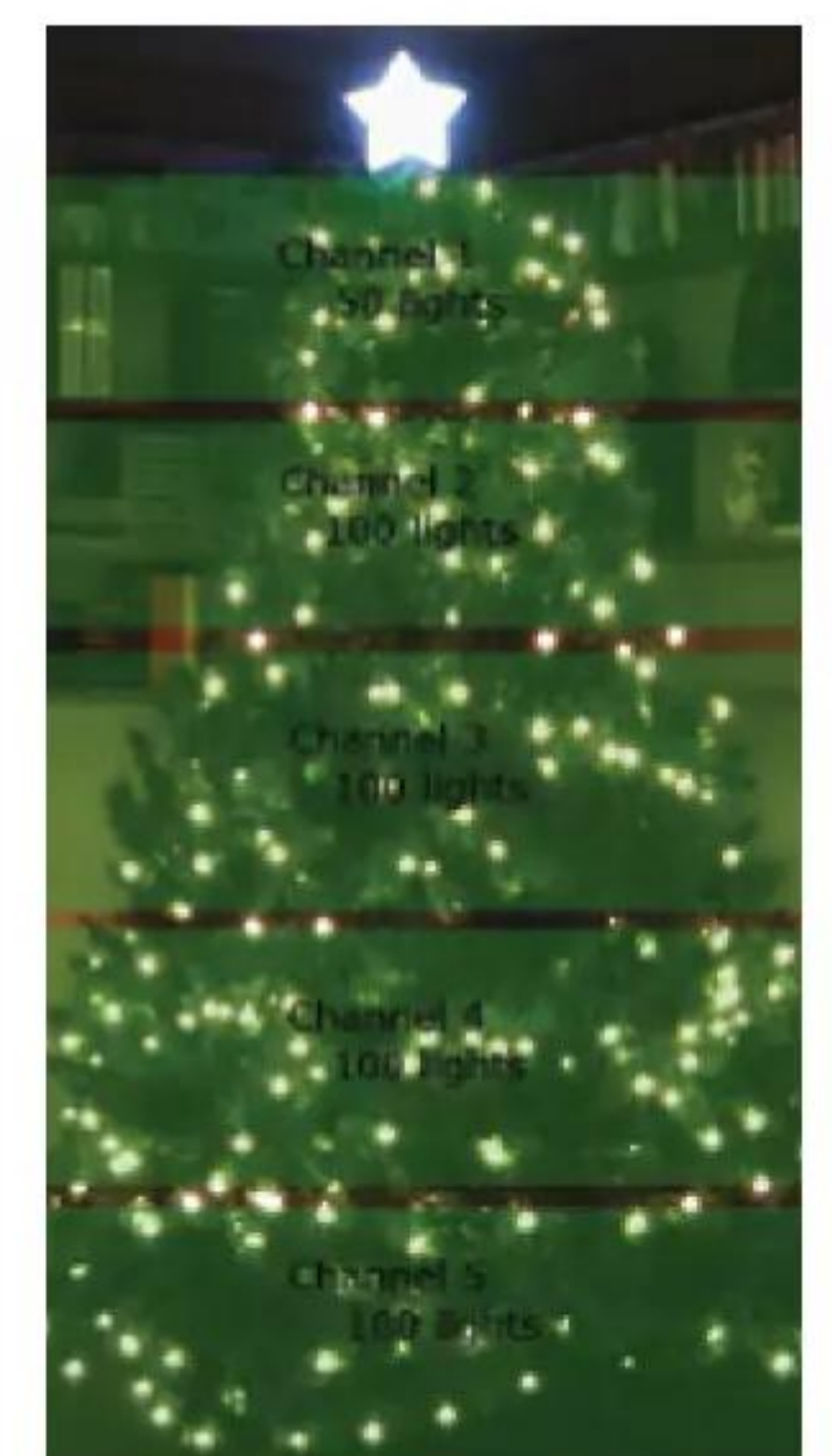



THE *Official*

RASPBERRY PI HANDBOOK

2025

THE OFFICIAL RASPBERRY PI HANDBOOK 2025



Olga Fortune Teller

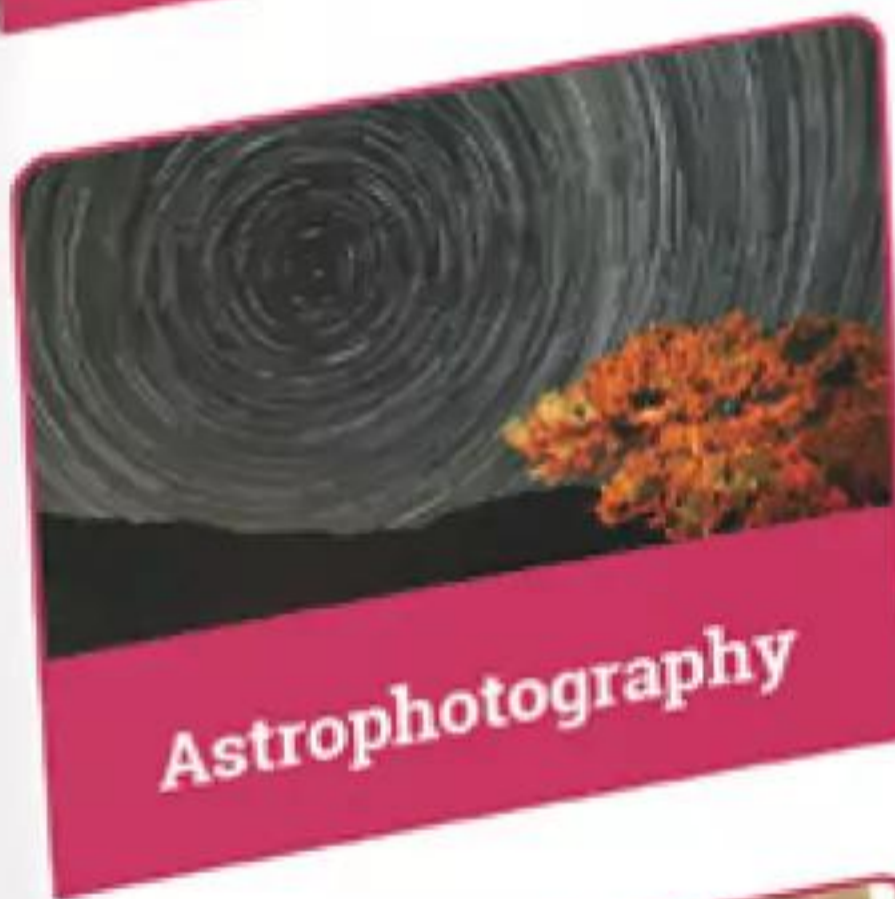

Astrophotography



Exoskeleton



Blue ROV2

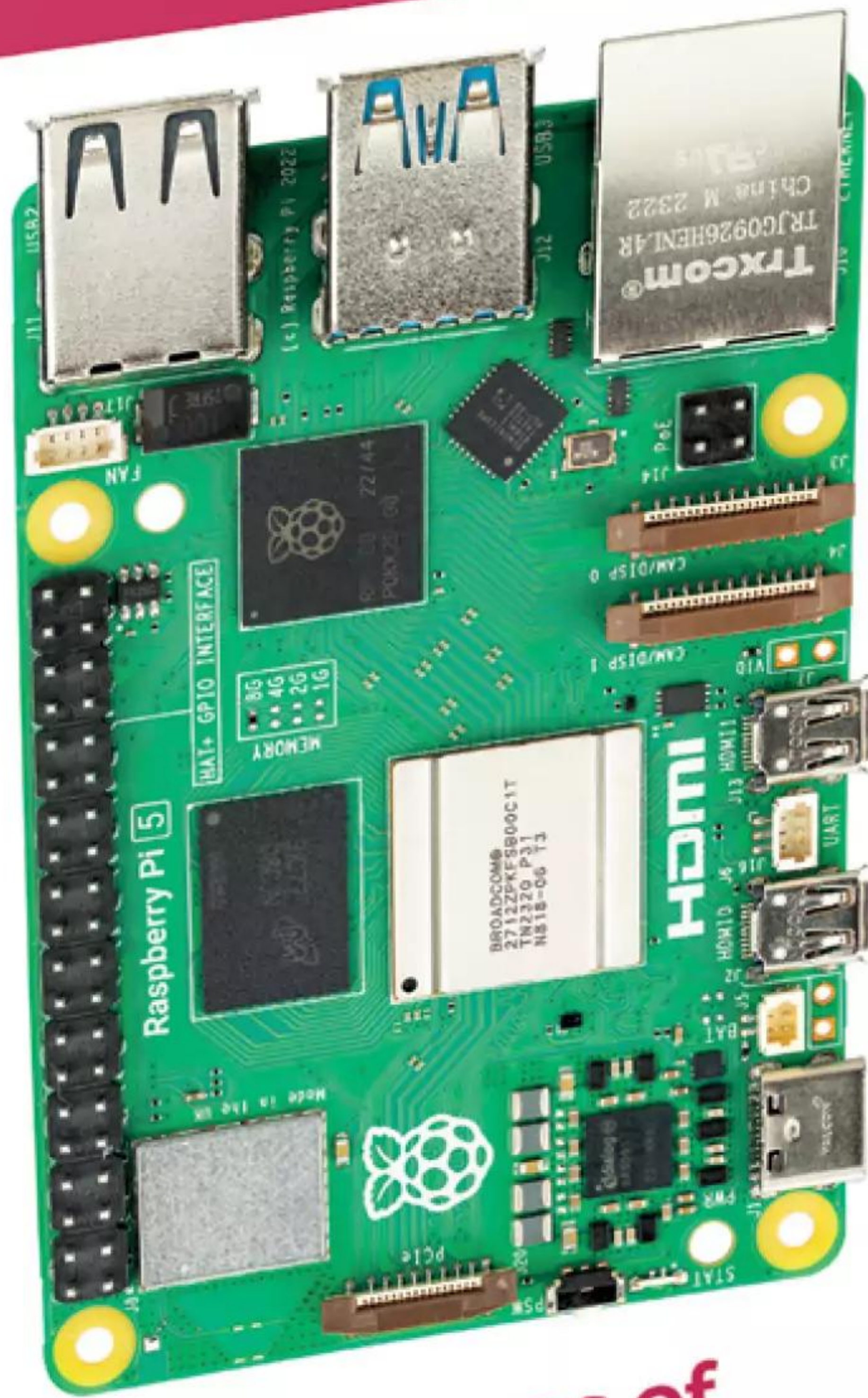

200 pages of
Amazing Makes!



Emulate a BBC Micro



CinePi XL



Python Robots



Including
RASPBERRY PI
PICO 2

FROM THE MAKERS OF *The MagPi* THE OFFICIAL RASPBERRY PI MAGAZINE

THE *Official*

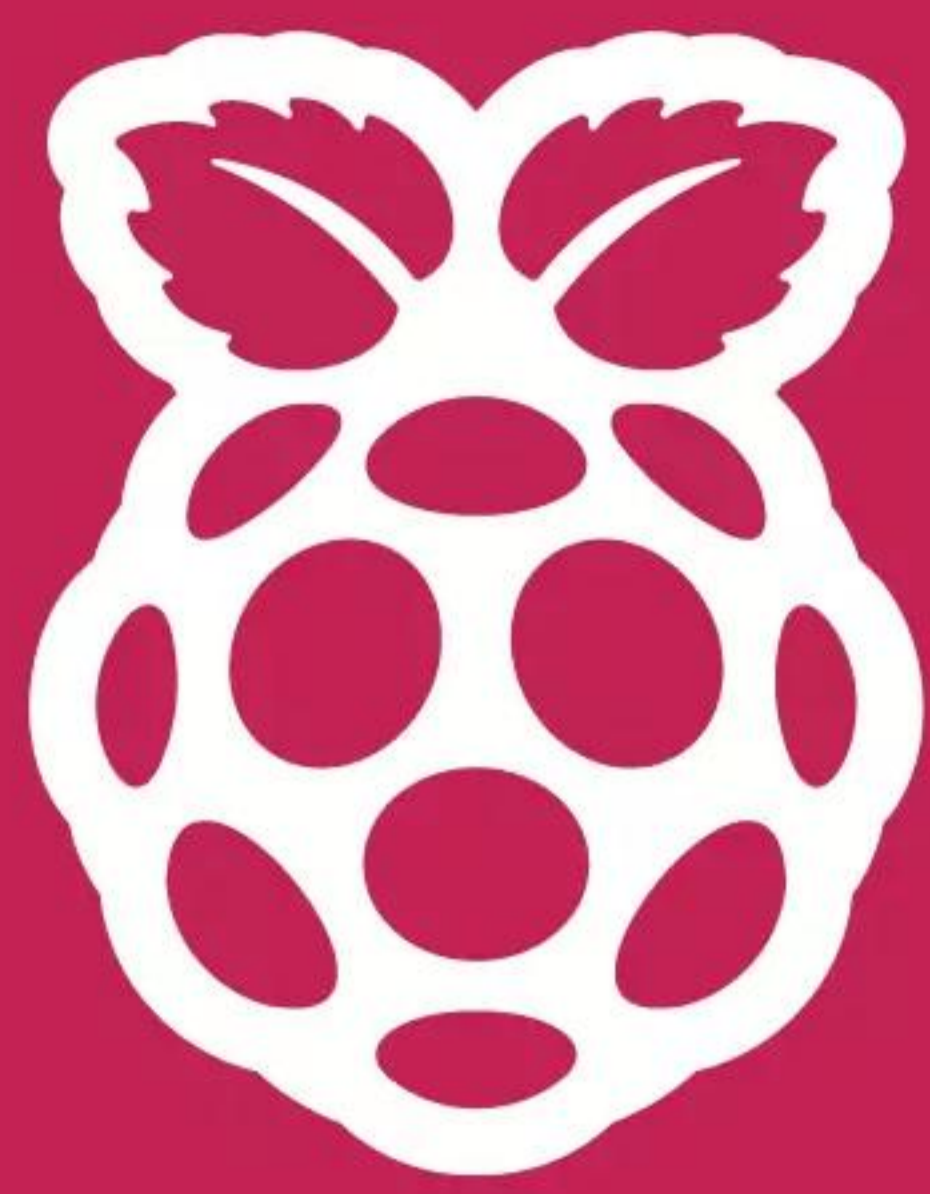

RASPBERRY PI HANDBOOK

2025



200 PAGES OF RASPBERRY PI

- A guide to getting started with every Raspberry Pi board
- All the essential info on the brand new Raspberry Pi Pico 2
- Inspiring projects to give you your next big idea
- Upgrade your emulation with next-gen retro gaming

Buy online: magpi.cc/store

MagPi Monday

Amazing projects direct from social media!

Every Monday we ask the question: have you made something with a Raspberry Pi over the weekend? Every Monday, our followers send us amazing photos and videos of the things they've made.

Here's a selection of some of the awesome things we got sent this month – and remember to follow along at the hashtag #MagPiMonday! 📺

01. We're fans of Blackberry projects here, and this one looks great
02. A really cool technical project, discovering how video signals work
03. Ah, a classic way to mount your camera: in a fictional robot's head
04. Honestly, we don't think we want to know anything more
05. Pepper's ghost is an old-school hologram-style effect and we love this interpretation
06. Hmm, why is this eyeball tracking your every move?
07. LEGO cases for Raspberry Pi are still very popular even in 2024
08. Aki making a cool custom monitor for Raspberry Pi
09. This is very cool, we wonder if you could have an entire library looking setup that is secretly a Raspberry Pi desktop computer
10. We hadn't quite appreciated how perfectly sized Raspberry Pi Zero is for model trains
11. Tesla coil music is something we always forgets exists but is an exceptionally cool concept
12. This is a really cool and colourful project, reminds us of Epcot
13. These photos are incredible! We love some good Raspberry Pi astrophotography
14. PPU stands for 'Picture Processing Unit' – this is cool and opens up a whole new world for NES homebrew

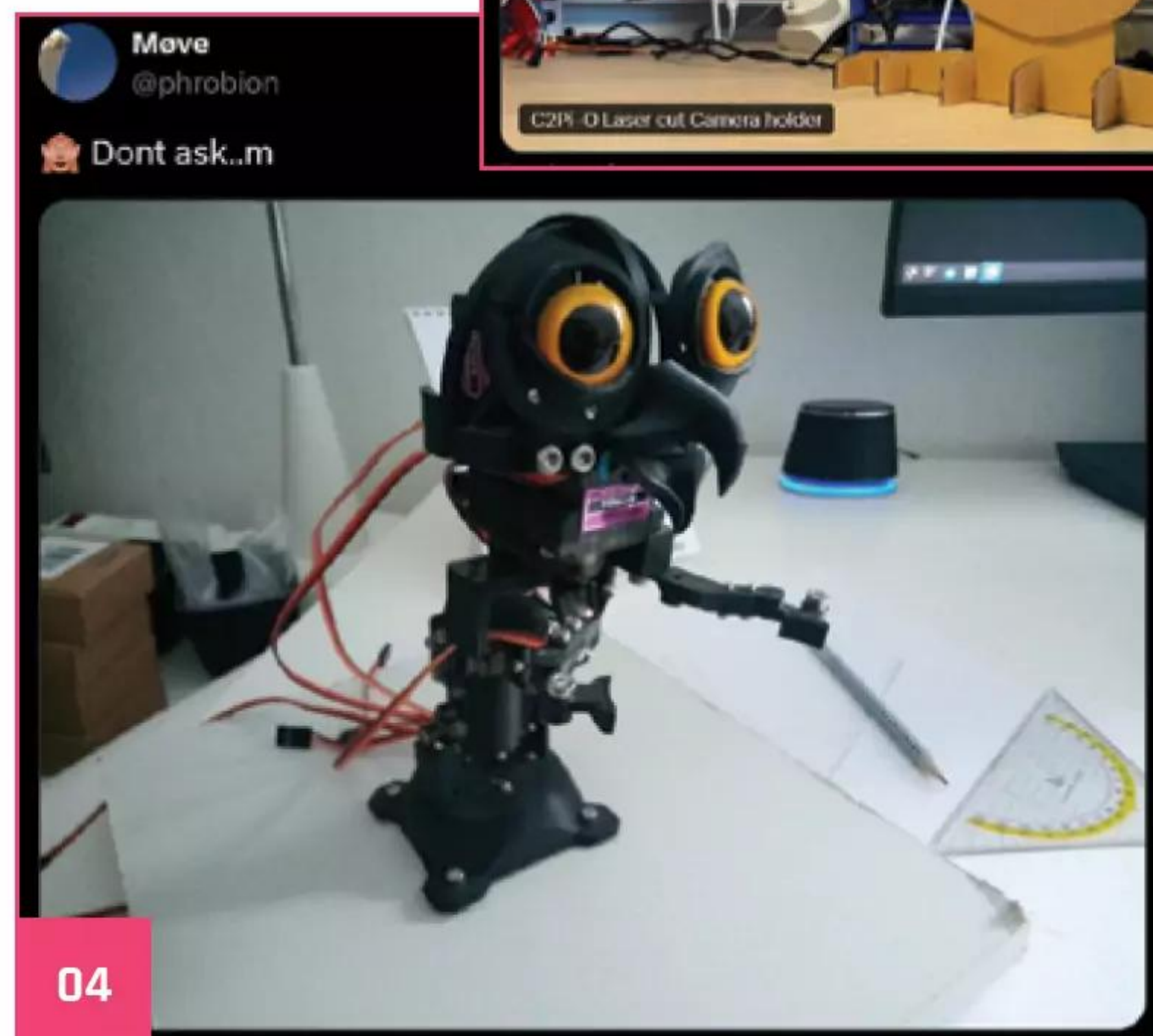
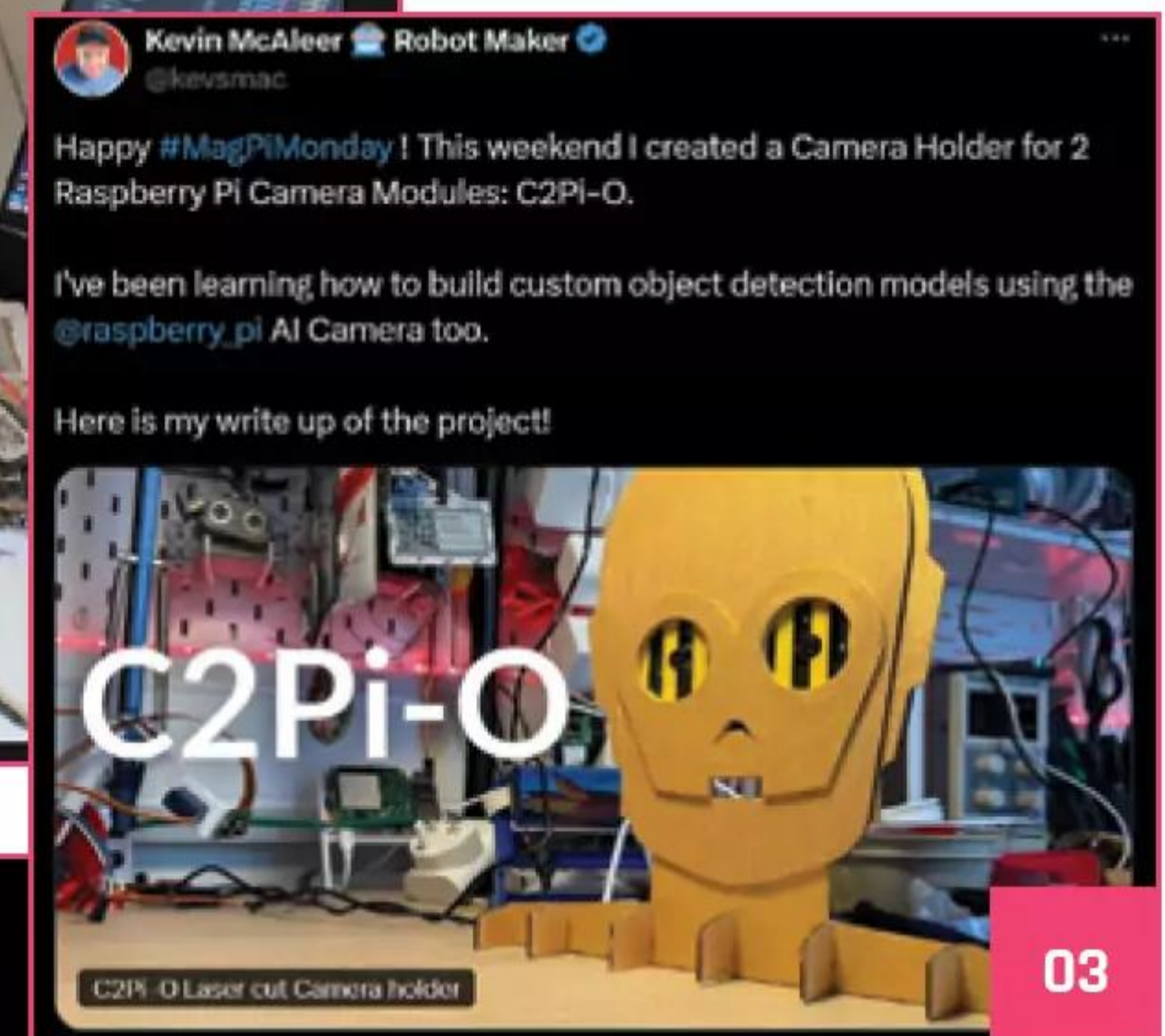
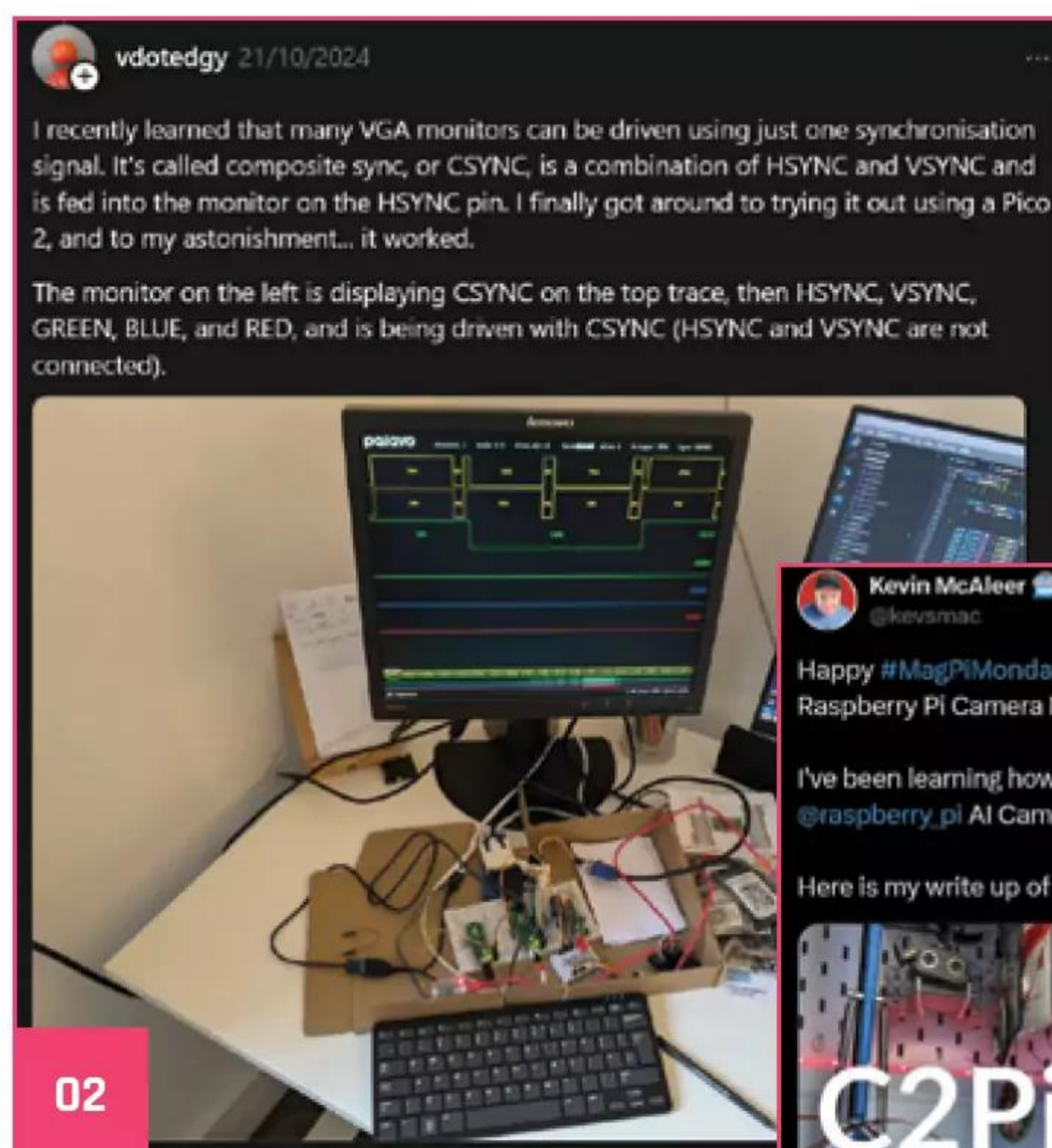
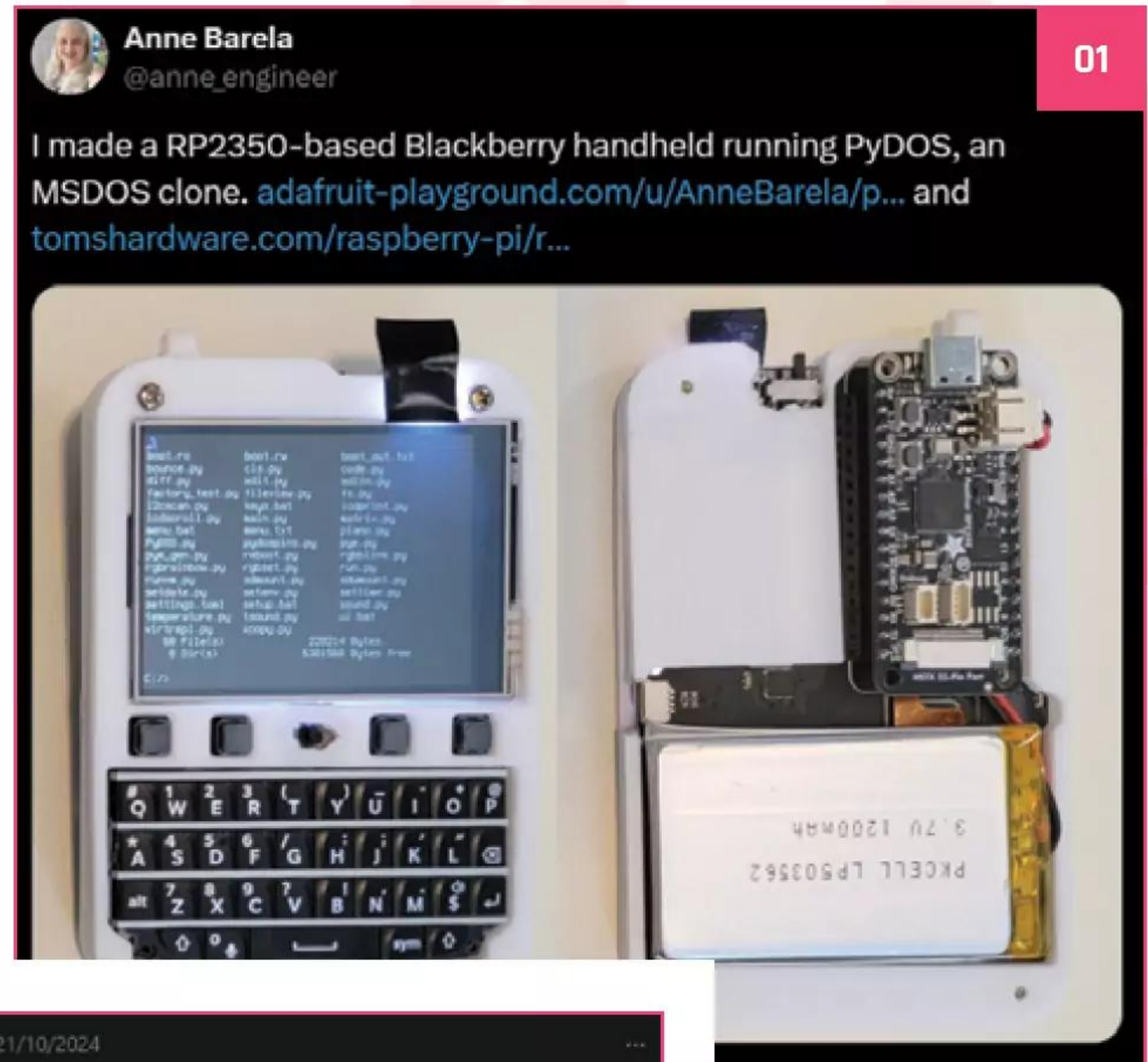

Alicen | LewisAndSpark
@alicen_lewis

05

Happy #magpimonday, I connected an NFC reader to a pi to make a pepper's ghost hologram machine 🤖

WriterOfMinds (she)
@WriterOfMinds

06

I just got a motion-tracking algorithm for my room-monitoring camera running on a Pi; you can read more about it and see video here: writerofminds.blogspot.com/2024/10/atrona...

Fatback Billy
@juzcauz

07

LEGOpiGo raspberry pi 4 Ubuntu tablet sitting in its base

あつきい
@akkiisoft@social.mikutter.hachune.net

08

@themagpi Morning!

I made the my own design of the PCD8544 monochrome LCD board for Raspberry Pi.

In this board, PCD8544 has connected to hardware SPI and the backlight can be controlled with GPIO.

It can also be used with Pico using a board I created that converts Pico GPIO to Pi GPIO.

I'm planning to create a signage that will graphically display sensor data such as room temperature, CO2, and room power consumption :)

logcite
@logcite@social.linux.pizza

09

@themagpi

I like doing that : customizing anything that could be used as a case for a raspberry pi.

Here a fake book with a rpi3, a DAC from #hifiberry, a power supply and also a #zigbee switch from #sonoff

Softwares : #lyrion, #homeassistant, #zigbee2mqtt

Pater Practicus
@PaterPracticus

10

Made further progress with #TrainCam. All now working, with track power to the @Raspberry_Pi Zero via the PowerBoost and voltage regulator. #MagPiMonday

Extreme Electronics
@Extelec@mstdn.social

11

@themagpi Pi Pico driven tesla coil that plays Wav files.

Rf generated directly from the Pi Pico.

Andrew Porter @defsdoor@ruby.social
@defsdoor

12

I finally (2 years in the making) finished my 320 facet Geodesic Sphere - powered by a RP2040.

youtube.com
4 November 2024

かぐら
@taka_hvc1@social.mikutter.hachune.net

14

@themagpi Controlling RP2C02 (NES PPU) with Pico.

github.com/taka-tuos/rp2c02-rp...

Translate

monkeymadenedoit
1d

13

We used the @raspberrypi camera and telescope to photograph some planets

USB volume controller

Fixing a day-to-day problem with a simple, custom, volume knob

Temirlan Yergazy got in touch with us over email about a little project he'd made to improve his TV-watching experience.

"I have a laptop that I watch YouTube and TV-series on, and sometimes, I need to adjust volume multiple times because of the volume fluctuations in the videos," Temirlan tells us. "But the problem with manually adjusting the volume is that I need to minimize the screen and adjust the volume from the taskbar. This is very annoying. So, I thought of making a USB volume controller that I can use to adjust the volume without minimizing the screen. Similar feature I had on my previous keyboard, that I don't have now."

He fixed this using a Pimoroni Tiny2040 and a rotary encoder attached to it.

"The board is programmed to act as a USB HID device (same as keyboard or mouse) that sends volume commands to the host computer. The rotary encoder is used to control the volume. Software used in this project is CircuitPython and HID library from Adafruit."

It's a neat little solution using just two components and a bit of code, which you can find here: magpi.cc/usbvol. 

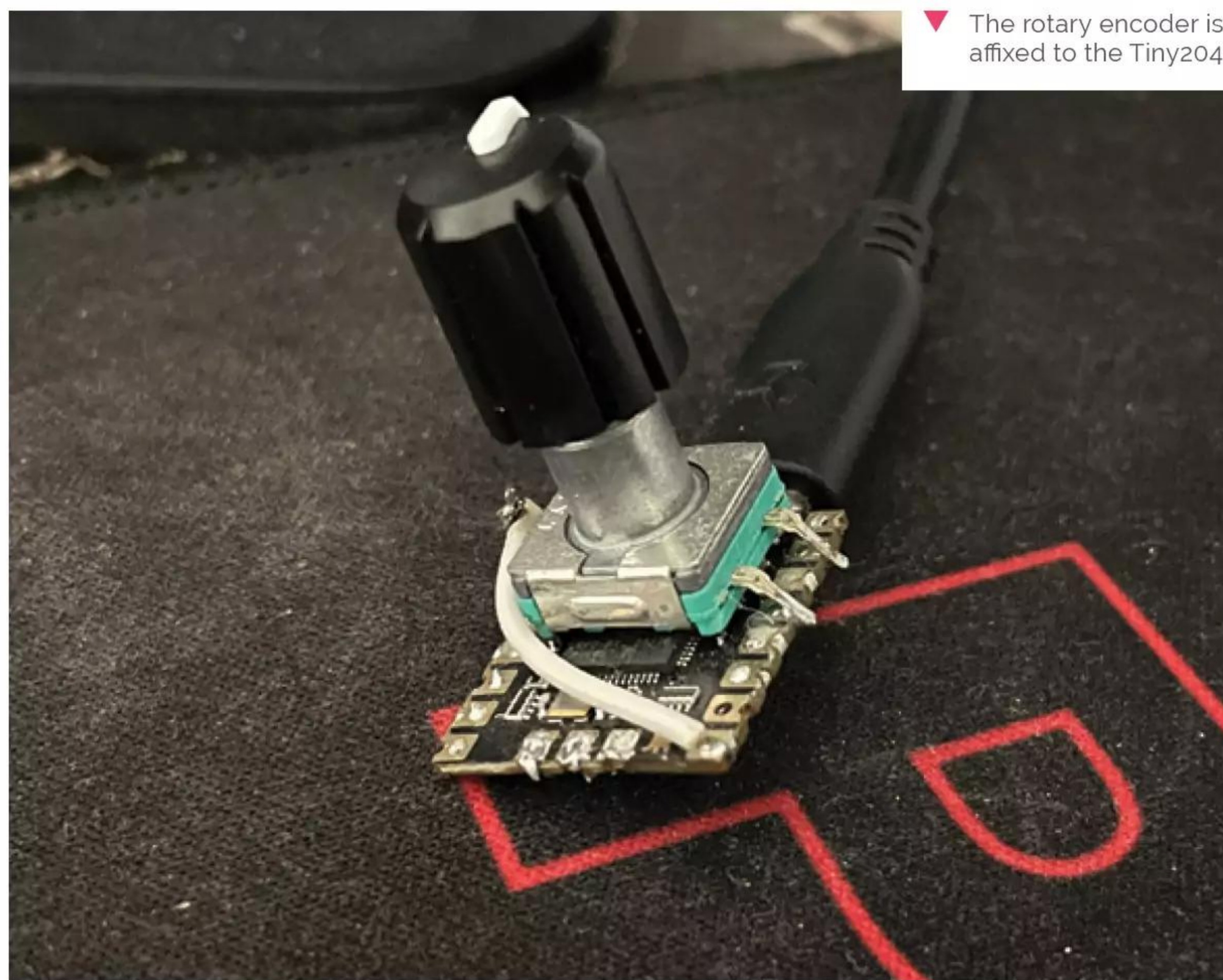

▼ The rotary encoder is affixed to the Tiny2040

▼ The whole set up is quite small and connects to a computer via a USB cable



▲ A visual confirmation comes up on screen of volume changing thanks to the UI on most modern PCs

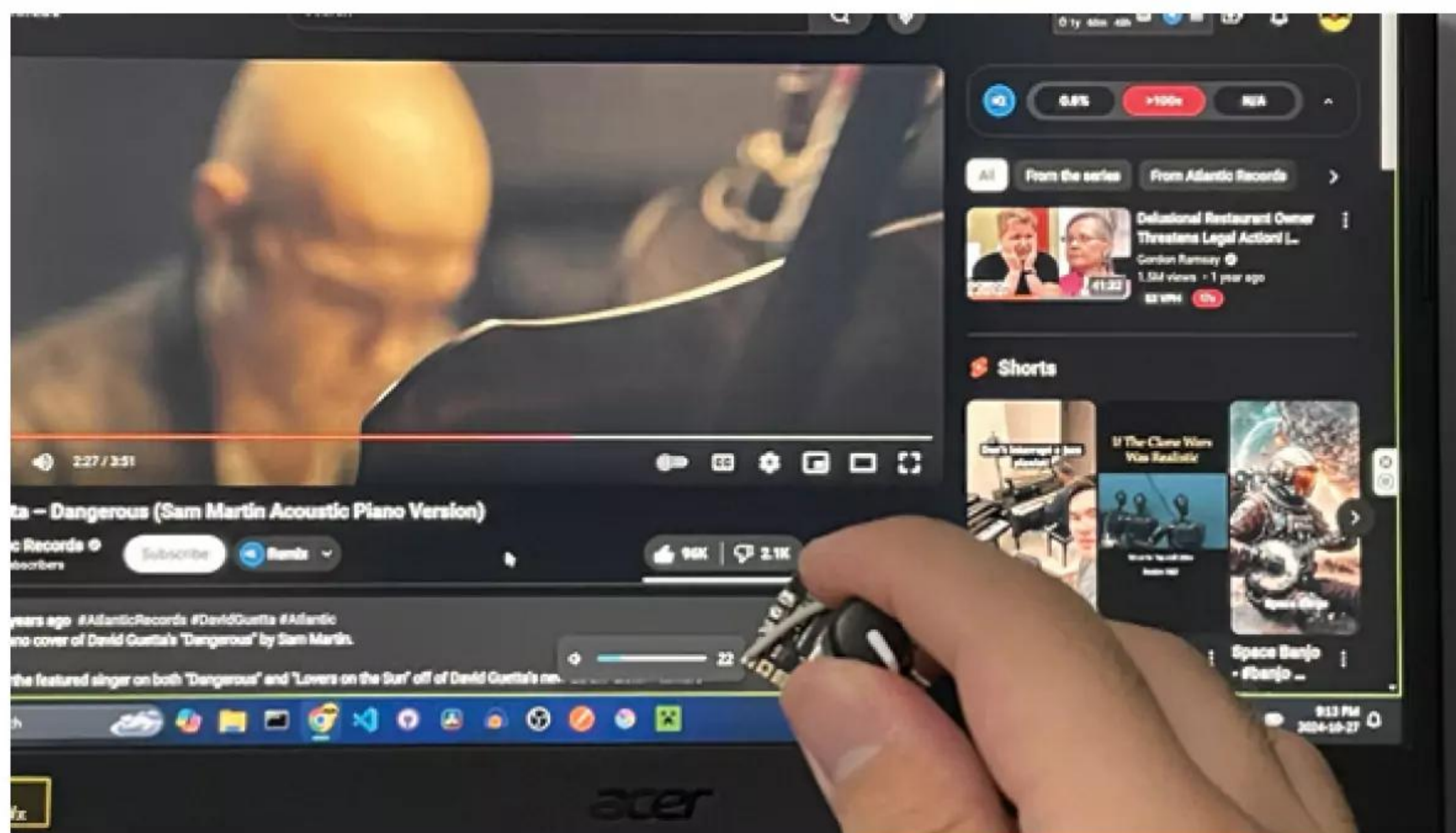

Best of the rest!

Other cool Raspberry Pi things we saw this month

TRACKING CREEPY EYE



We didn't see a huge amount of Halloween projects this year but the few we did see were pretty great – like this creepy eye that is displayed on a matrix of seven-segment displays

► magpi.cc/creepyeye

RASPBERRY PI IN A TURBOEXPRESS



Also known as the PC Engine GT, this relatively obscure handheld is yet another old console that's been converted to work with a Raspberry Pi, and we think that's cool.

► magpi.cc/turbogt

Together we can make a difference

Give young people the opportunity to learn about technology

The Raspberry Pi Foundation enables young people to realise their full potential through the power of digital technologies, but we can't do this work without your help. Your support helps us give young people the opportunities they need in today's world. Together we can offer thousands more young people across the globe the chance to learn to create with digital technologies.

Generous donations from organisations and individuals who share our mission make our work possible.



DONATE NOW

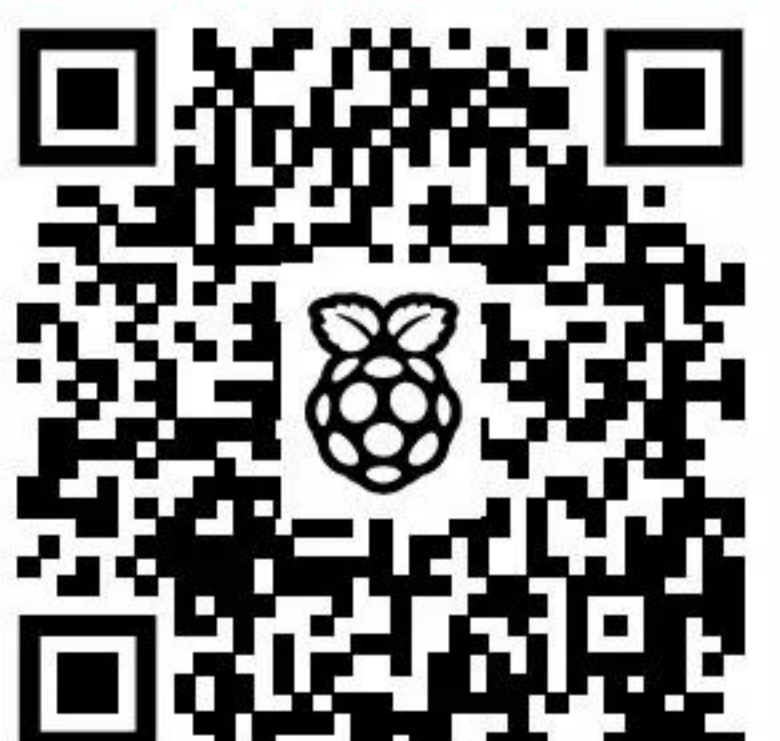

Donate today to make a difference: rpf.io/magpidonate

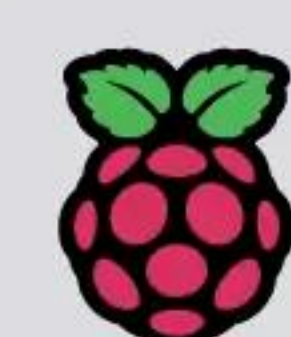

Raspberry Pi
Foundation

Your Letters

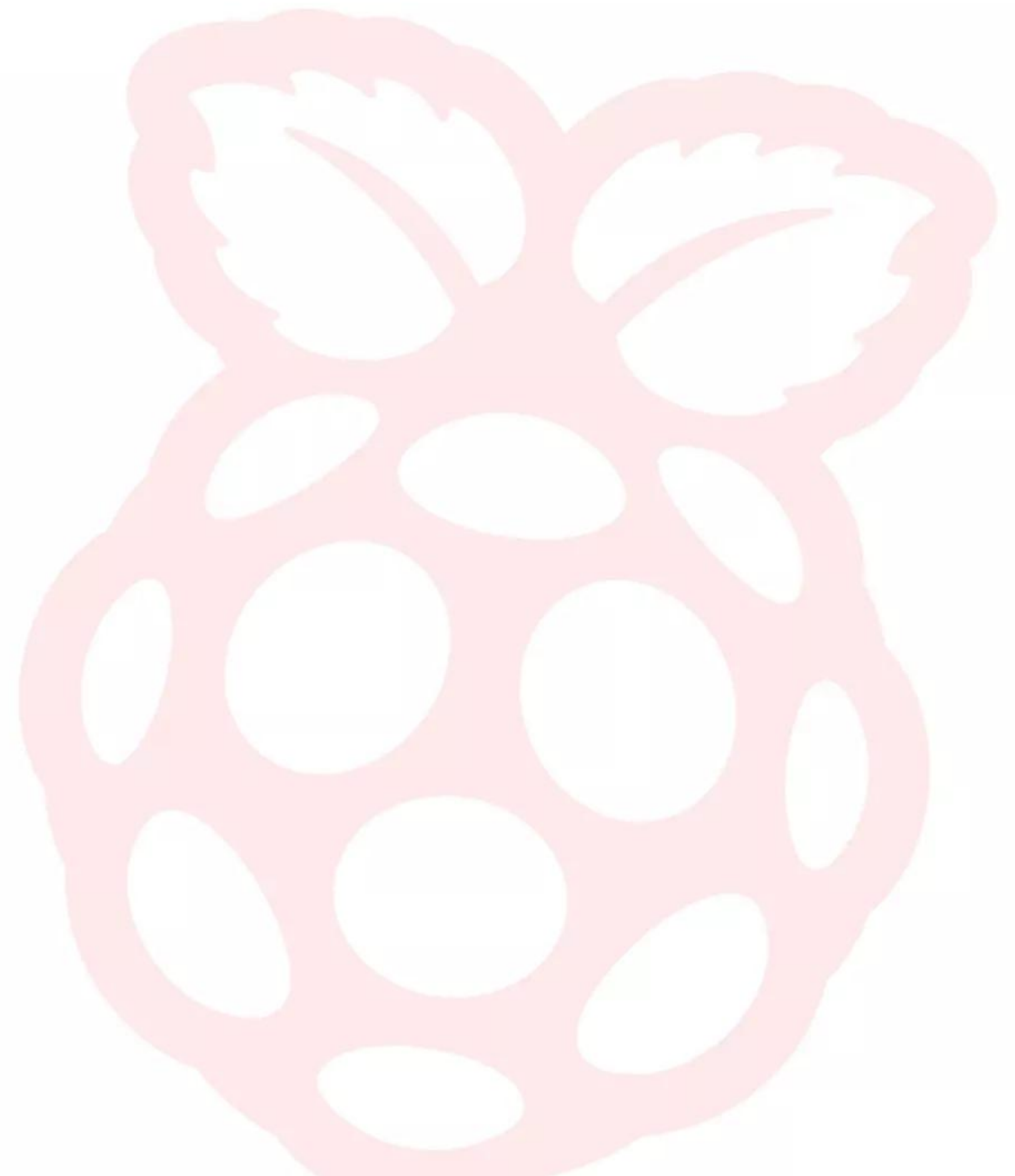

Gadget types

I'm after copies of your magazine, numbers 139 and 140, which are sold out! Are these both available as paid-for downloads, or even reprints?

Chris via email

While the PDFs for the magazines are currently only available to print subscribers and contributors, that is only for the first three weeks! *MagPi* issues 139 and 140 are therefore available for free from our website, as well as all our other back issues.

You can find them all at magpi.cc/issues, and you can print them for yourself as well if you'd prefer them to be physical.

▶ As we write, this Touch Display 2 is the newest product that was announced, but there may be more by the time you read this

Raspberry Pi overload

You seem to be releasing a lot of new products at the moment! My wallet can't quite keep up, although at least it means I have plenty of things to put on my Christmas list.

Is there a reason so much is coming out at once? Not that I'm complaining...

Aya via email

There is quite a lot of new stuff at the moment, and there's been more announced since you sent this email, including the new release of Raspberry Pi OS. Much like the way an updated OS is largely dependant on Debian releases, the rest of the products are things that have been in development for varying lengths of time and just happened to be ready at the same time.

It does mean we have lots of cool stuff to play with whenever we're in the office though. Hopefully your wallet and Christmas list can hold out!

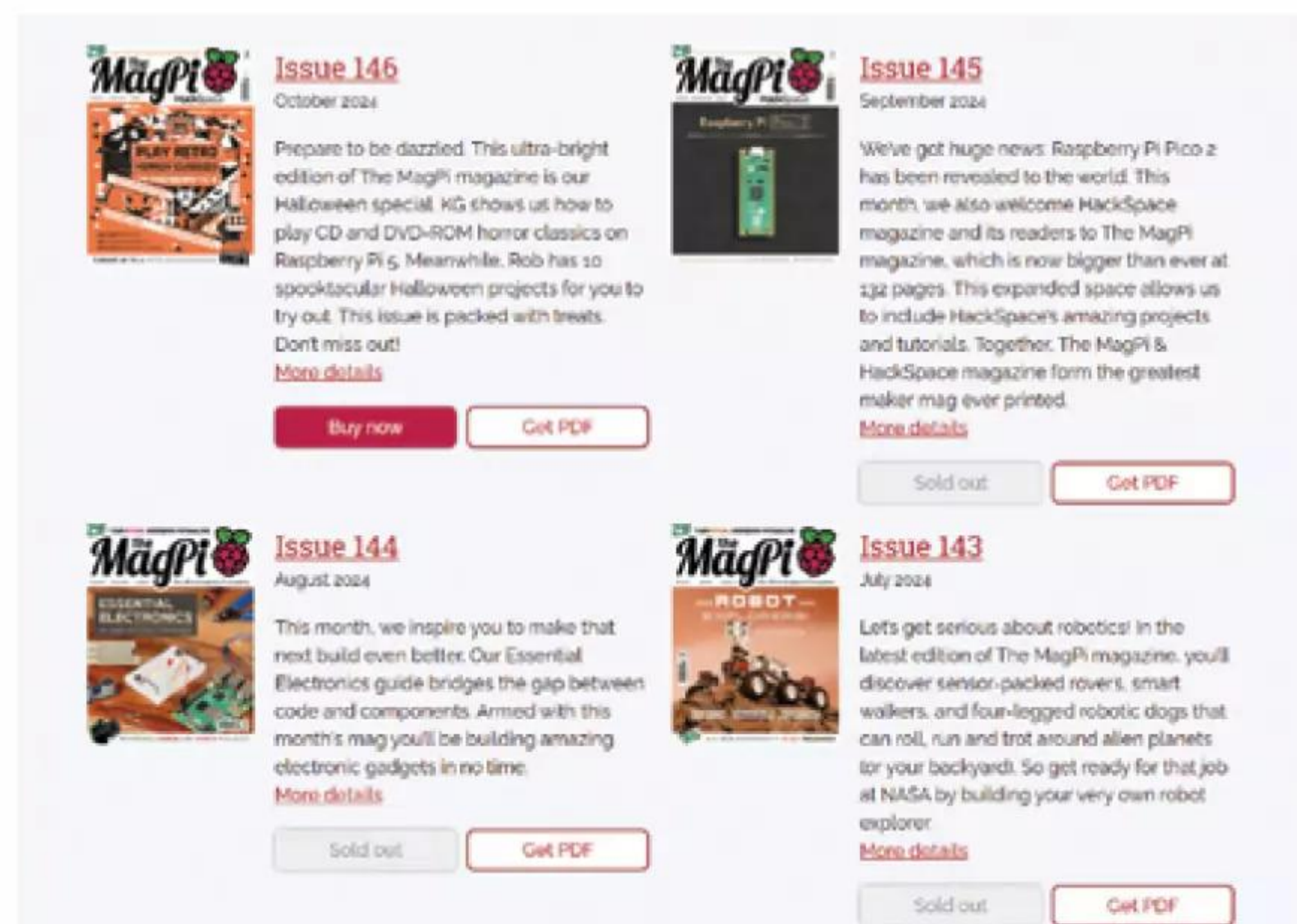

▶ All our back issues are available as free PDFs direct from our website

Holiday showcase

I have a festive project for December that I'm planning – will I be able to submit it to you once it's done? Or will you not be doing any Christmas content in the issues after? I enjoy seeing what other people make in your magazine, and would like to be one of those people.

Sam via Facebook

A cool project is a cool project, and we're happy to showcase any seasonal project all year round. If there's a load of Christmas-themed projects we might also collect them all into one big article like #MagPiMonday in the community section.

Whether you've got Christmas, Halloween, Bastille Day, White Day, or any other holiday project, we'd love to see it and are happy to publish it at any time of year.



▲ If you need any festive inspiration, check out page 114 for some illuminating ideas

Contact us!

- ▶ Mastodon magpi.cc/mastodon
- ▶ Threads [@themagpimag](https://themagpimag)
- ▶ Facebook magpi.cc/facebook
- ▶ Email magpi@raspberrypi.com
- ▶ Online forums.raspberrypi.com

USA SPECIAL! 6 ISSUES FOR \$43



FREE RASPBERRY PI PICO W

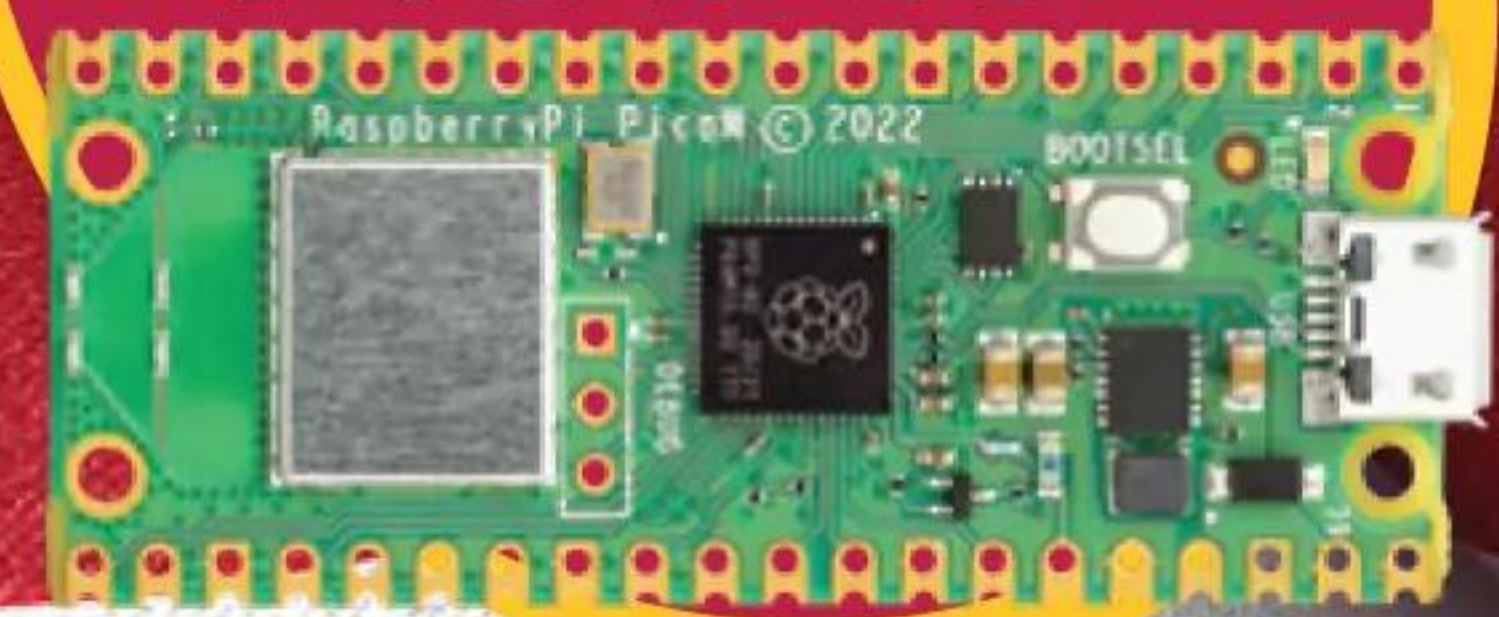

Subscribe online:
magpi.cc/subscribe

Continuous credit card orders will auto-renew at the same price unless cancelled.
A free Pico W is included with all subscriptions. This is a limited offer.
Not included with renewals. Offer subject to change or withdrawal at any time.



Community Events Calendar

Find out what community-organised Raspberry Pi-themed events are happening near you...

01. PLUG in the Pub

- ☐ Thursday 28 November
- 📍 Hygge Bar, Perth, Australia
- ▶ magpi.cc/plug148

Come eat, drink, chat, hack and socialise. We are easy going and it's a very casual event. If you don't drink alcohol, we would still love to have you there. You don't have to be a member to come along.

02. Melbourne Raspberry Pi Meetup

- ☐ Sunday 1 December
- 📍 Docklands Makerspace and Library, Melbourne, Australia
- ▶ magpi.cc/mrpm148

This meetup is open to everyone with an interest in electronics, robotics, home automation, 3D printing, laser cutting, amateur radio, high altitude balloons, space tech, etc. Makers are invited to bring along their projects and project ideas, and come and connect with other makers. Get your questions answered, show off the work you are doing, and get support to resolve nagging issues.



03. Riverside Raspberry Microprocessor Showdown

- ☐ Monday 2 December
- 📍 Ann Arbor District Library, Ann Arbor, MI, USA
- ▶ magpi.cc/showdown24

Riverside Raspberry is a California-based enthusiast group that's been meeting up for almost a decade. This group will appeal to thinkers and tinkerers, the scientifically curious, software developers looking to get into embedded development, or anyone young or old that has a knack for tech in general.

In this annual showcase of tech projects, you can try out basic coding and physical computing on several different platforms, including the Raspberry Pi 5. Try your hand at making wearable tech, solar-powered Morse Code transceivers, blackout poetry, computerised object detection, animation with Scratch, live dance music, and much more

04. Cornwall Tech jam

- ☐ Saturday 14 December
- 📍 Fraddon Village Hall, Fraddon, UK
- ▶ magpi.cc/ctj148

The Cornwall Tech Jam returns to Fraddon Village Hall in December for four hours of fun for children to learn to code. It's likely there will be some Christmas-themed coding too. The Cornwall Tech Jams are an ideal place for children to learn to code, develop important problem-solving skills, meet like-minded friends and generally have a great time.

FULL CALENDAR
Get a full list of upcoming community events here:
magpi.cc/events

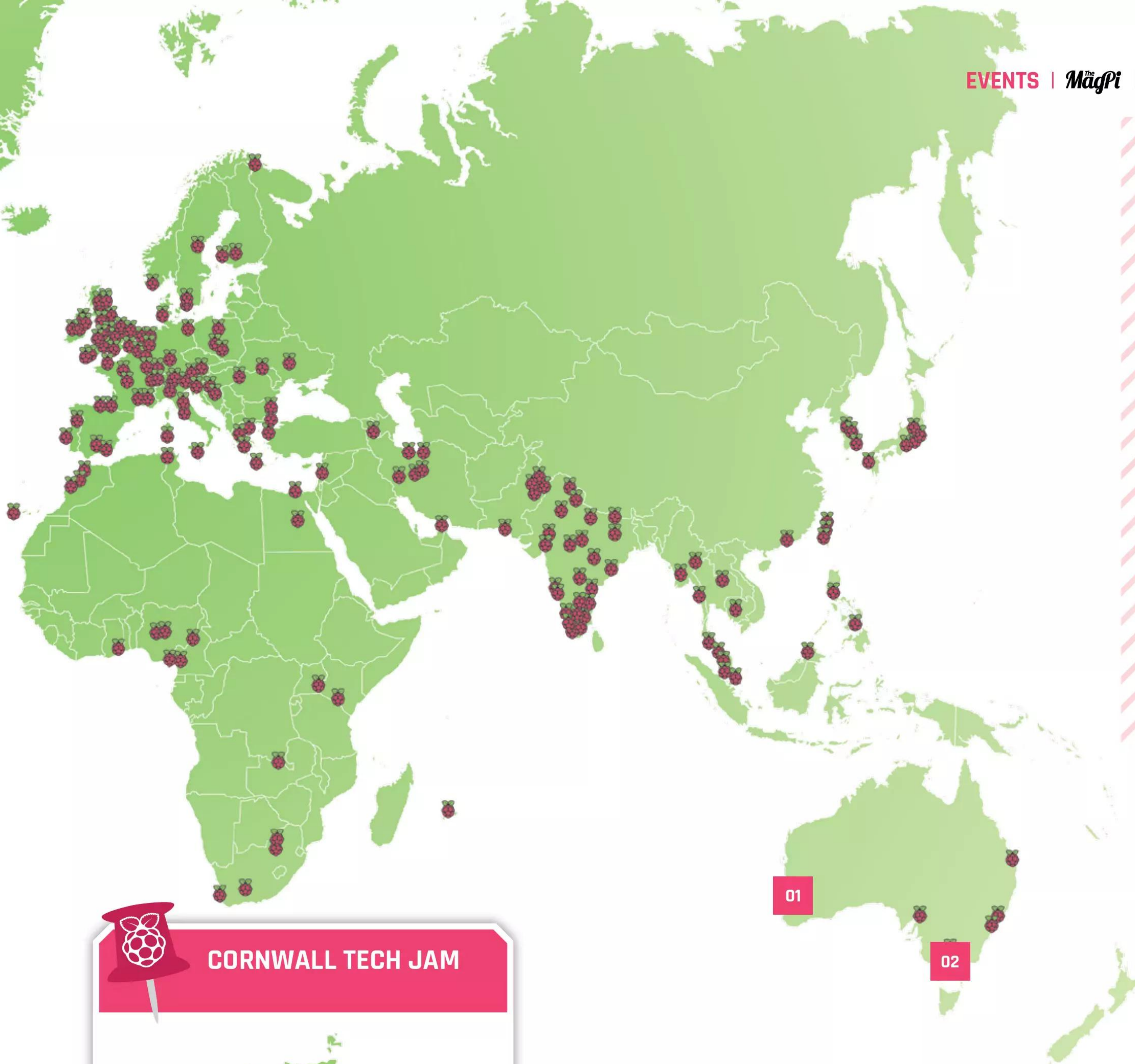

CORNWALL TECH JAM



Christmas

- > Where **Your rooftop**
- > When **Wednesday 25 December**

Our sources tell us that Raspberry Pi gifts should be making their way to your home this Christmas Day, delivered (supposedly) by a bearded man dressed in red. When asked for comment, Raspberry Pi CEO Eben Upton ignored us and went back to work.

magpi.cc/xmas

WIN ONE OF THREE

THUMBY COLOR

The tiny Thumbby Color is powered by RP2350 and allows you to develop fun games and play cool exclusives that other folks have made too! It comes preloaded with games that run out of the box, and even includes rumble. We have three to give away.



Head here to enter: magpi.cc/win | **Learn more:** magpi.cc/thumbbycolor

Terms & Conditions

Competition opens on **20 November 2024** and closes on **19 December 2024**. Prize is offered to participants worldwide aged 13 or over, except employees of Raspberry Pi Ltd, the prize supplier, their families, or friends. Winners will be notified by email no more than 30 days after the competition closes. By entering the competition, the winner consents to any publicity generated from the competition, in print and online. Participants agree to receive occasional newsletters from The MagPi magazine. We don't like spam: participants' details will remain strictly confidential and won't be shared with third parties. Prizes are non-negotiable and no cash alternative will be offered. Winners will be contacted by email to arrange delivery. Any winners who have not responded 60 days after the initial email is sent will have their prize revoked. This promotion is in no way sponsored, endorsed or administered by, or associated with, Instagram, Facebook, Twitter or any other companies used to promote the service.

- Learn coding ■
- Discover how computers work ■
- Build amazing things! ■

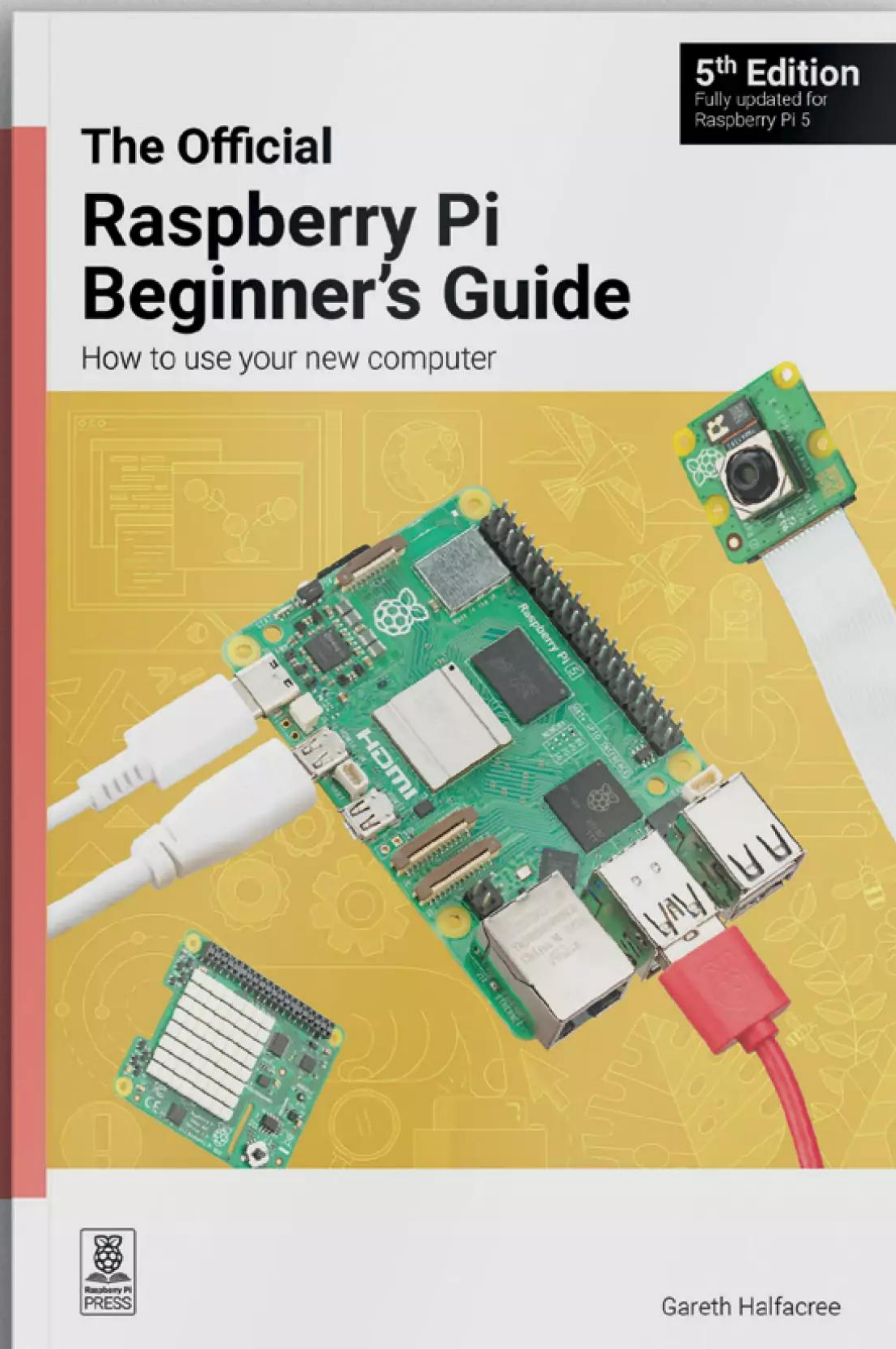

magpi.cc/beginnersguide

Design an RP2040 board with KiCad

Creating Raspberry Pi Pico-compatible PCBs

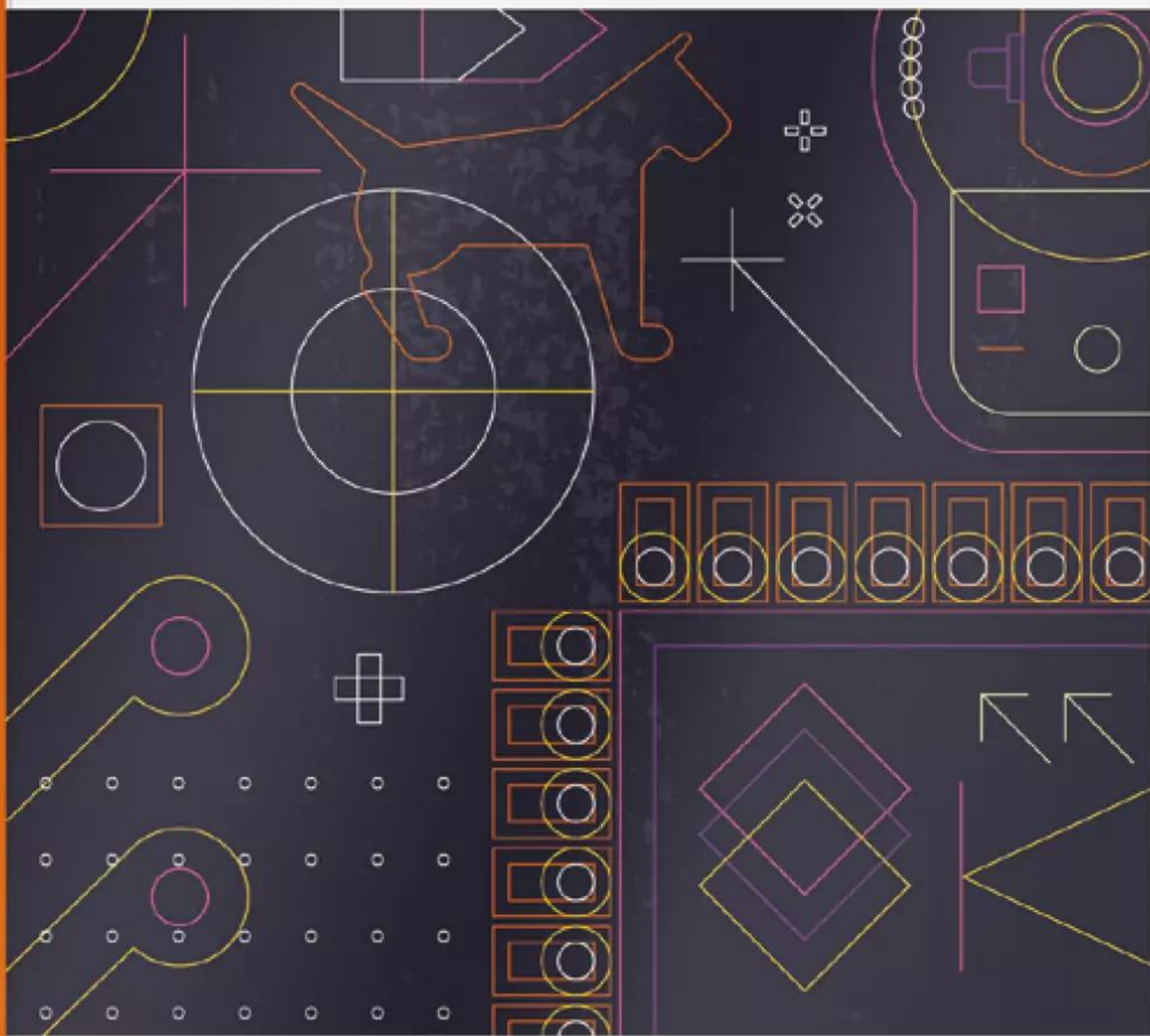

Jo Hinchliffe,
Ben Everard

KiCad is an amazing piece of free and open source software that allows anyone, with some time and effort, to make high-quality PCB designs.

- *Create a schematic for a microcontroller board using Raspberry Pi's RP2040*
- *Select the right components*
- *Customise the hardware for your needs*
- *Lay out and route the PCB design*
- *Prepare your board for manufacture and assembly*
- *Write software to get your design working*

Buy online: magpi.cc/kicad2040

RASPBERRY PI DESKTOP

Thin computing, home Linux, and
personal computing with Raspberry Pi



The MagPi **#149**
On sale **19 December**

Plus!

Starter guide for
newcomers

Mapping caves
with Shake

Implementing
Compute Module

DON'T MISS OUT! magpi.cc/subscribe

MASTODON magpi.cc/mastodon

THREADS [@themagpimag](https://twitter.com/themagpimag)

FACEBOOK magpi.cc/facebook

EMAIL magpi@raspberrypi.com

ONLINE forums.raspberrypi.com

EDITORIAL

Editor

Lucy Hattersley
lucy@raspberrypi.com

Features Editor

Andrew Gregory
andrew.gregory@raspberrypi.com

Features Editor

Rob Zwetsloot
rob@raspberrypi.com

Sub Editor

Ian Evenden

ADVERTISING

Charlotte Milligan
charlotte.milligan@raspberrypi.com
+44 (0)7725 368887

DESIGN

Designer

Lee Allen

Illustrator

Sam Alder

Photographer

Brian O Halloran

CONTRIBUTORS

David Crookes, PJ Evans, Rosemary Hattersley, Phil King, Nicola King, Andrew Lewis, Simon Long, Rob Miles, KG Orphanides, Naush Patuck, Eben Upton

PUBLISHING

Publishing Director

Brian Jepson
brian.jepson@raspberrypi.com

Director of Communications

Helen Lynn

CEO

Eben Upton

DISTRIBUTION

Seymour Distribution Ltd
2 East Poultry Ave,
London EC1A 9PT
+44 (0)207 429 4000

SUBSCRIPTIONS

Unit 6 The Enterprise Centre
Kelvin Lane, Manor Royal,
Crawley, West Sussex, RH10 9PE
+44 (0)1293 312193
magpi.cc/subscribe
magpi@subscriptionhelpline.co.uk



This magazine is printed on paper sourced from sustainable forests and the printer operates an environmental management system which has been assessed as conforming to ISO 14001.

The MagPi magazine is published by Raspberry Pi Ltd, 194 Cambridge Science Park, Milton Road, Cambridge, England, CB4 0AB. The publisher, editor, and contributors accept no responsibility in respect of any omissions or errors relating to goods, products, or services referred to or advertised in the magazine. Except where otherwise noted, content in this magazine is licensed

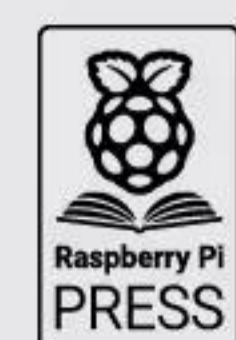

under a Creative Commons Attribution-NonCommercial-ShareAlike 3.0 Unported (CC BY-NC-SA 3.0).
ISSN: 2051-9982.



Putting AI to use

Lucy Hattersley has all the AI kit and an urge to build something real

Brace yourself, because I'm about to talk again about this year's thrilling but worn-out topic: artificial intelligence.

First of all: I'm not a fan of the term. It's misleading, because people focus too much on the 'intelligence' part and not enough on the 'artificial' aspect. More than that: it's vague. AI is used to describe everything from fictional sci-fi megabrain to barely functional chatbots and 'ducking' predictive text, leading people to dismiss the whole thing as bunk.

It's far better to discuss the underlying technologies that make it all work: machine learning, deep learning, natural language processing, knowledge graphs, and especially computer vision.

That last one means a lot to us, because Raspberry Pi has released its AI Camera and I for one can't wait to start putting it to serious use (the fantastic AI Kit is now an all-in-one AI HAT with a Hailo accelerator running at up to 26 TOPS, enabling a wider range of non-vision ML projects, which is also looking very handsome at this point).

A lot is going on with this equipment, and things are starting to get serious: Sony has been using the AI Camera on its production line. Look at Sony's AITRIOS developer site (magpi.cc/imx500dev) for more information on how AI Camera is genuinely useful from an industrial point of view. We're hoping to get some great tutorials with them lined up

“ A lot is going on with this equipment, and things are starting to get serious ”

While the usefulness of AI is like Schrodinger's cat, both existing and not existing at the same time, I think it's important to remember that the underlying technologies have real and serious purposes in industry, education, and healthcare. It's not all trying to get ChatGPT to figure out how many times the letter 'r' appears in 'strawberry'.

I recently updated my iPhone to use Apple Intelligence (there are not enough rolling eyes in the world) and it's producing some handy overviews of email conversations. While this is all well and good, it is Raspberry Pi that's putting AI in an industrial setting. You can hook an AI Camera to a Raspberry Pi and get it to do real-world things.

My personal involvement with testing and writing about AI started out with Google AIY (which went on to become the Coral toolkit). This add-on to Raspberry Pi gave it a TensorFlow Lite machine learning accelerator and the USB Accelerator with a Google Edge TPU coprocessor provides 4 TOPs (tera-operations per second). We've built teachable machines, I'm now delighted to have an AI Camera and AI HAT and am very open to ideas. Let's build something wild. 

Lucy Hattersley

Lucy Hattersley is editor of *The MagPi* and is currently working with the SenseHAT so maybe, just maybe, will make something smart and sense-y.

magpi.raspberrypi.com

HiPi.io

HIGHPI PRO

———— The new case from the HiPi.io team ————.



- Rapid tool-free assembly and disassembly
- Large internal volume for HATs
- Compatible with Pi 2/3/4
- Multiple lid options
- Passive & Active Cooling options

- Secure microSD card cover
- VESA mount support
- Molding-configurable output ports customizable for volume orders
- Printed logo for your branding

Available at these great Pi stores:



Contact your favorite Pi store if it's not listed here

PiKVM

Remote control **redefined**

Manage your servers or PCs remotely!



PiKVM V4 Mini

Small, cost-effective, and powerful!

- Power consumption in idle mode: just 2.67 Watts!
- Transfer your mouse and keyboard actions
- Access to all configuration settings like UEFI/BIOS
- Capture video signal up to 1920x1200@60 Hz
- Take full control of a remote PC's power

PiKVM V4 Plus

The most feature-rich edition

- More connectivity
- Extra storage via internal USB3.0
- Upgraded powering options
- More physical security features
- Extra HDMI output
- Advanced cooling solution



A cost-effective solution for data-centers, IT departments or remote machines!

Available at the main Raspberry Pi resellers



HiPi.io

No reseller in your country?
Check shop.hipi.io (import fees might apply).

List of official resellers by country:

